

CMP Cable Glands & Accessories





CMP Products

What We Promise for Your Business

CMP Products is a market leading specialist designer, manufacturer, and supplier of cable glands, cleats and accessories. Established as part of British Engines group in 1957, we have ensured that our customers remain at the heart of everything that we do, wherever they are around the world.

We believe in setting standards for quality and service, and leading the way in product innovation, whilst maintaining integrity, safety and reliability. This means that whether our products are used for onshore or offshore oil and gas installations, in power generation, transportation infrastructure, or for surface or underground mining applications, they always protect the safety of your people and your infrastructure.

By remaining focused on this commitment to our customers, our business has grown to become a world leader in our market, continuing to provide assurance of the highest standards of quality and service.

Innovation in Products & Solutions

Evolving technical standards and stringent certification processes have helped to drive innovation at CMP. As a market leader in cable gland and cleat technology, we invest heavily in advanced

manufacturing techniques, dedicated IT systems and effective training for our employees and customers.

The solutions chosen by our customers are often rigorously tested to perform above and beyond the normal standards, since they are used in progressively demanding applications and environments.

People & Networks

CMP's structure allows us the flexibility to meet these continuously evolving needs, and we nurture this culture further by recruiting specialist, highly talented people in all areas of our business.

We have also formed excellent relationships with the people and organisations that do business with us, developing alliances with distributors and end-users internationally. This network is key to our strategy for bringing products to a worldwide market, via a strategic global distribution network reflective of our business.

Customer Care

Putting the customer at the centre of what we do and ensuring a positive experience for everyone we work with is a vital part of our vision.

An Introduction to Cable

Cable Glands are mechanical cable entry devices, which can be constructed from metallic or non-metallic materials or a combination of both, and are used throughout all industries in conjunction with cable and wiring used in the electrical, instrumentation, control and automation systems.

Cable Glands may be used on all types of electrical power, control, instrumentation, data and telecommunications cables and are used as sealing/terminating devices to ensure that the characteristics of the enclosure which the cable enters can be safely maintained. The main functions of the Cable Gland, depending on type, are listed briefly as follows:

- Provide environmental protection by sealing on the outer cable sheath, excluding dust and moisture from the electrical or instrument enclosure.
- In the case of armoured cables facilitate earth continuity, when the Cable Gland has a metallic construction. In this case Cable Glands may be tested to ensure that they can withstand a minimum short circuit fault current, corresponding to that of the cable armour or peak fault of the electrical system.

- Provide a holding force on the cable to ensure adequate levels of cable pull out resistance, and prevent lateral and axial loads being applied to the internal cable conductor terminations.
- Provide additional sealing on the part of the cable entering the enclosure, when a high degree of ingress protection is required.
- Provide additional environmental sealing at the cable entry point, maintaining the ingress protection rating of the enclosure and cable gland combination, with the selection of applicable accessories dedicated to performing this function.
- Constructed from corrosion-resistant materials determined by selection to a technical standard, or by corrosion resistance tests.

When used in explosive atmospheres it is crucial that Cable Glands are selected correctly according to the specified installation code or standard requirements, taking into account any certification limitations or conditions of use, are approved for the type of cable selected, and maintain the level of protection of the equipment to which they are attached.







CMP Products Cable Gland Range

Industrial Cable Glands	16
SOLO - Low, Smoke & Fume Cable Glands	34
CIEL - Cast Integral Earth Lug Equipped Cable Glands	40
ZEN - Insulated Cable Glands	46
Explosive Atmosphere Cable Glands	52
RapidEx Resin Barrier Cable Glands	82
Compound Barrier Cable Glands	92
ThermEx & ThermIn - High Temperature Cable Glands	100
Flat-Form Cable Glands	110
Mining Cable Glands	114
North American Cable Glands	130

CMP Products Accessory Range

Adaptors & Reducers	151
Stopper Plugs	158
Breather / Drain Plugs	161
Unions	162
Installation Accessories	168
Installation Tools	170





Why Choose CMP Products?

Quality Assurance & Reliability

CMP Products has an international reputation for quality and reliability and is highly regarded as the leading specialist in the design and manufacture of cable glands and accessories for industrial and explosive atmospheres.

This position as market leader is maintained by listening to our customers and understanding their needs, to ensure that our solutions are practical to install and fully compliant with the latest industry standards and specifications.

In recognition of the need to demonstrate and maintain standards, CMP Products has attained approval as a 'quality assured' company, covering the design and manufacture of Cable Glands, Cable Cleats and associated accessories. Our Quality Management System is approved to ISO 9001 : 2008 and Environmental Management System ISO 14001 with our 3rd party periodic audit and ongoing approval is performed by Bureau Veritas.

Research & Development

Research and development (R&D) is fundamental to the successful advances made with our product innovations and is a major contributor to helping customers achieve reciprocal success, whilst setting CMP apart from the rest of the market. R&D at CMP Products is powered by an engineering community of highly skilled technical experts in several locations around the world.



Such a comprehensive R&D team allows us to create bespoke solutions to meet the needs of our customers, which in turn can be thoroughly tested in our on-site certified laboratory and additionally third party certified if required.

Material Selection

We use only the best quality materials to suit the arduous conditions that our products often face. Our brass Cable Glands are produced using material grade CuZn39Pb3 (CW614N) to EN 12168 and EN 12164, stainless steel Cable Glands are produced

using material grade 316L to BS EN 10088:Part 3, and copper free aluminium Cable Glands manufactured from grade AW-6262 to EN 573-3. Polymer components and products are also produced in Low Smoke & Fume (LSF), Low Smoke Zero Halogen (LSZH or LSOH), or Zero Halogen Low Smoke (ZHLS) materials. CMP Products believes strongly in providing value and does not compromise in its choice of materials that could otherwise jeopardise its ultra-high quality solutions.

Compliance with Current Standards

CMP Products leads the way in the application of technical standards and with a dedicated certification team we design, manufacture and supply products that are compliant with all of the latest standards for IEC, NEC and CEC based installations.

Technical Support & Training

With several offices spread across six continents including Europe, the Americas, Australia, Asia and Africa we are able to satisfy the worldwide demand for comprehensive training in the installation of our products.



Attendees at all CMP training courses will receive a certificate of proficiency following successful completion. We also provide installation videos, as well as technical support and practical demonstrations at your premises or on-site.

Global Certification

CMP Products remains in constant touch with the changes in development of national and international technical standards, and consequently is able to offer product solutions that are certified for multiple applications around the world. This entails a number of single off-the-shelf product solutions marked with Global Certification as standard.

International explosive atmospheres approvals held include ATEX, IECEx, cCSAus, CSA, UL, KCS, NEPSI, CIDET, CCOE / PESO, RETIE, EAC, INMETRO, and Global Marine Approvals.



CMP Products Cable Glands - The Key Features

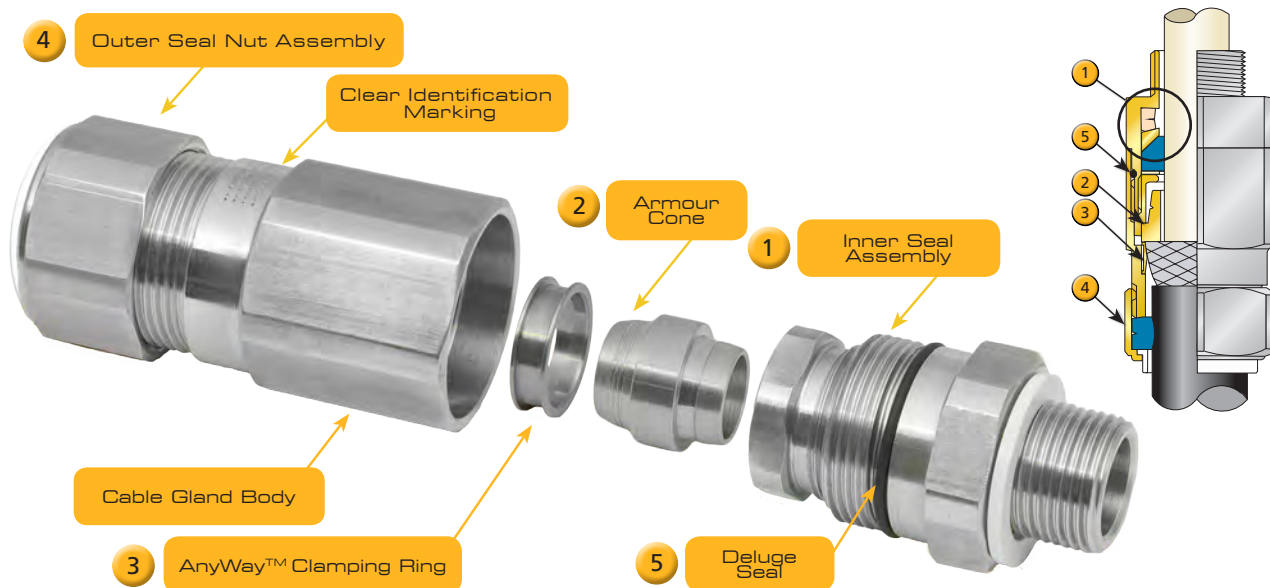

Above is a typical CMP double seal Cable Gland showing the parts in an exploded view.

1 Unique Independent Inner Sealing

The CMP inner sealing principal is quite different from other cable gland types and because the activation of the inner sealing ring is separated from the armour clamping components this means that the possibility of inadvertent over-tightening is eliminated. Unlike traditional compression seals that have no means of direct control on their application, the CMP inner sealing technique is achieved using a displacement seal that is independently controlled by the user during installation.

The Compensating Displacement Seal System (1) has helped CMP to take its original displacement sealing ring concept to another level. The unique Compensator has allowed the cable gland components to be fully tightened metal-to-metal and relieve the potential excess forces that could be transferred to the cable bedding, eliminating cable damage.

2 3 Secure Armour Termination

CMP Products' armour clamping method involves a unique termination solution that ensures a permanent crimping of the cable armour, creating a low impedance connection that does not suffer from self-loosening. The patented AnyWay™ clamping ring aids an easy 'Right First Time' installation. Secure armour clamping like this also contributes to enhanced levels of EMC performance as well as reliable earth continuity.

4 Outer Seal

The unique CMP Products Outer Seal Tightening Guide (OSTG) and Load Retention Sealing Ring (LRS) ensure an IP/NEMA rated seal is formed against the cable to the CORRECT degree. This is also applicable to our sealing rings on unarmoured Cable Glands.

5 Proven Internally Enclosed Deluge Seal

CMP Products integrated 'O' ring deluge seal (tested to DTS 01:91) prevents corrosion of the cable armour by ensuring that moisture cannot track around the Cable Gland threads and into the armour termination body. As an internally enclosed deluge seal the 'O' ring is protected from mechanical damage and harmful UV rays.

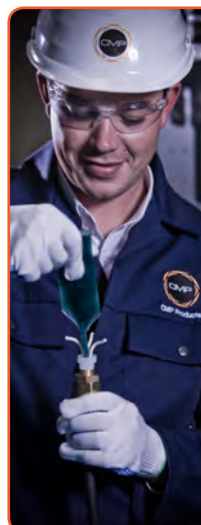

Barrier Glands Made Easy

RapidEx is a liquid pour, fast curing, liquid resin barrier seal that installs in seconds and cures in minutes.

Its unique formula begins with a low viscosity liquid that flows into the cable interstices completely surrounding the cable conductors, and in the process, displacing the air from the Cable Gland's sealing chamber ensuring the 'Perfect Seal'.



Selecting the Correct Cable Gland & Accessories

The following steps together with the information throughout this catalogue will ensure that the CMP Cable Gland selected will be fit for purpose and perform to relevant specifications.

- Identify the type of cable to be used
- Check the construction, size and material properties of the cable

When the cable is armoured, check the following:

- The type and material of the cable armour*
- The short circuit fault current rating of the cable armour**
- The diameter of the inner bedding (where present) 'A'
- The diameter of the lead covering (where present)
- The size of the overall cable diameter 'B'
- The size and type of armour or braid (where present) 'C'

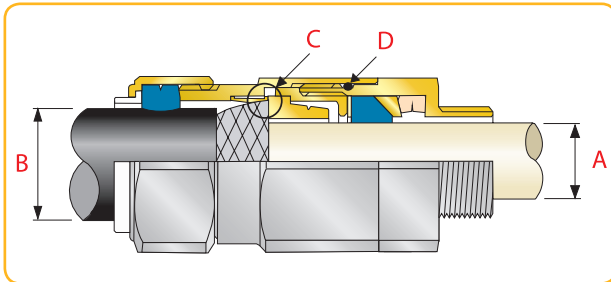

Understanding the installation the Cable Gland is intended, Check the following:

- Any special environmental requirements in relation to corrosion protection
- The material of the mating electrical enclosures to eliminate dissimilar metals where possible
- Whether any protective plating or coating is required to be applied to the Cable Gland, e.g. Nickel Plating
- The type and size of the cable entry hole in the mating electrical equipment
- The wall thickness of the enclosure or gland plate, as a longer cable gland thread may be required
- The ingress protection rating of the electrical equipment or site standard required to be maintained

- Whether a single seal or double seal Cable Gland is required
- If an entry thread sealing washer is required to meet the ingress protection rating
- Is there is a deluge protection requirement 'D'
- If fixing accessories such as locknuts and serrated washers are required
- If an earth tag is required**
- If shrouds are required
- If a thread conversion adaptor/reducer is required to complete the installation
- If any stopper plugs are required to close unused cable entries
- Select a Cable Gland type

For installations in explosive atmospheres, special considerations should be taken into account to ensure compliance with national or international standard codes of practice.

Accessory Selection

In addition to entry thread sealing washers, CMP also provides locknuts, earth tags, serrated washers and shrouds as required, which should be used as appropriate to the installation standard or equipment configuration.

These CMP accessories may be critical to the safety of the installation and overall performance, it is vital that the CMP accessories are correctly specified and installed. Accessories are not typically included with the cable glands as standard, unless a cable gland pack/kit is ordered.

In order to maintain product warranty it is vital that genuine CMP accessories are used for installation of CMP cable glands. Compatibility of material selection, short circuit rating (in the case of earth tags) and sealing performance (in the case of sealing washers) cannot be guaranteed if accessories from other sources are used.

**If the cable armour is of a non-standard material, e.g. Aluminium Wire Armour, it may be necessary to consider an alternative Cable Gland material, e.g. Aluminium.*

***For certain medium voltage and high voltage cables CIEL Cable Glands may be required.*



Typical Configurations

The illustrations provided below are indicative of some of the common methods of installation configurations adopted. These are for informative guidance only and relevant site conditions and Engineering Specification along with any specified National or International Codes of Practice must always take precedence.

PARALLEL THREADED CABLE GLAND THROUGH CLEARANCE HOLE

Earth continuity may be achieved via Earth Tag when specified

Locknut (3.2 mm),
Sealing Washer (2.0 mm),
16 Gauge Stainless Steel Enclosure Wall (1.6 mm) –
Total 6.8 mm

Cable Gland Thread Length = 10.0 mm

Light Duty Enclosure

IP66
IP67
IP68

Locknut

Entry Thread Seal

PARALLEL X PARALLEL ADAPTOR THROUGH CLEARANCE HOLE

Earth continuity may be achieved via Earth Tag when specified

Optional Serrated Washer
Locknut (3.2 mm),
Serrated Washer (3.3 mm),
Sealing Washer (2.0 mm),
16 Gauge Stainless Steel Enclosure Wall (1.6 mm) –
Total 10.1 mm

Cable Gland Thread Length = 15.0 mm

Light Duty Enclosure

IP66

Optional Serrated Washer

Locknut

Earth Tag

Parallel x Parallel Adaptor

Entry Thread Seal

When using an Earth Tag in IP67, 68 applications please contact CMP

PARALLEL THREADED CABLE GLAND INTO THREADED ENCLOSURE

Earth continuity may be achieved via threaded entry or Earth Tag when specified

Sealing Washer (2.0 mm),
Enclosure Wall (6.0 mm) –
Total 8.0 mm

Cable Gland Thread Length = 10.0 mm

Metallic Threaded Enclosure

IP66
IP67
IP68

Entry Thread Seal

PARALLEL X PARALLEL ADAPTOR THROUGH CLEARANCE HOLE

Earth continuity may be achieved via Earth Tag when specified

Locknut (3.2 mm),
Serrated Washer (3.3 mm),
Sealing Washer (2.0 mm),
16 Gauge Stainless Steel Enclosure Wall (1.6 mm) –
Total 10.1 mm

Cable Gland Thread Length = 15.0 mm

Light Duty Enclosure

IP66
IP67**
IP68**

Optional Serrated Washer

Locknut

Earth Tag

Parallel x Parallel Adaptor

Entry Thread Seal

TAPER THREADED CABLE GLAND THROUGH CLEARANCE HOLE

Earth continuity may be achieved via Earth Tag when specified

Optional Serrated Washer
Locknut (4.75 mm),
Serrated Washer (3.7 mm),
Sealing Washer (2.0 mm),
Earth Tag (1.5 mm),
10 Gauge Galvanised Steel Enclosure Wall (3.5 mm) –
Total 15.45 mm

Cable Gland Thread Length = 19.9 mm

Light Duty Enclosure

IP66

Optional Serrated Washer

Locknut

Earth Tag

Entry Thread Seal

When using an Earth Tag in IP67, 68 applications please contact CMP

PARALLEL X PARALLEL ADAPTOR INTO THREADED ENCLOSURE

Earth continuity achieved via threaded entry or Earth Tag when specified

Sealing Washer (2.0 mm),
Enclosure Wall (10.0 mm) –
Total 12.0 mm

Cable Gland Thread Length = 15.0 mm

Metallic Threaded Enclosure

IP66

Sealing Washer

Earth Tag

Parallel x Parallel Adaptor

Entry Thread Seal

When using an Earth Tag in IP67, 68 applications please contact CMP

TAPER THREADED CABLE GLAND INTO THREADED ENCLOSURE

Earth continuity achieved via threaded entry

Note that care needs to be taken to ensure that the cables are protected as they pass into the enclosure when the wall section is greater than the Cable Gland thread length

Metallic Threaded Enclosure

IP66
IP67**
IP68**

Gap

PARALLEL X TAPERED ADAPTOR THROUGH CLEARANCE HOLE

Earth continuity may be achieved via Earth Tag when specified

Locknut (3.2 mm),
Serrated Washer (3.3 mm),
Sealing Washer (2.0 mm),
Earth Tag (1.5 mm),
10 Gauge Galvanised Steel Enclosure Wall (3.5 mm) –
Total 13.5 mm

Cable Gland Thread Length = 15.0 mm

Light Duty Enclosure

IP66

Serrated Washer

Locknut

Earth Tag

Parallel x Tapered Adaptor

Entry Thread Seal

Gap

When using an Earth Tag in IP67, 68 applications please contact CMP

TAPERED X TAPERED ADAPTOR INTO THREADED ENCLOSURE

Earth continuity may be achieved via threaded entry or Earth Tag when specified

Metallic Threaded Enclosure

IP66
IP67**
IP68**

Gap

Tapered x Tapered Adaptor

PARALLEL X TAPERED ADAPTOR INTO THREADED ENCLOSURE

Earth continuity may be achieved via threaded entry or Earth Tag when specified

Sealing Washer (2.0 mm),
Earth Tag (1.5 mm),
Enclosure Wall (7.5 mm) –
Total 11.0 mm

Cable Gland Thread Length = 15.0 mm

Metallic Threaded Enclosure

IP66

Sealing Washer

Earth Tag

Parallel x Tapered Adaptor

Entry Thread Seal

Gap

When using an Earth Tag in IP67, 68 applications please contact CMP

* IP67, IP68 Rating with deluge seal ** IP67, IP68 Rating with deluge seal and appropriate thread grease on tapered threads

CMP NPT threads do not require additional sealing for IP66 since a male CMP NPT thread fitted to an enclosure / equipment with a female NPT entry thread will maintain equipment Ingress Protection ratings of IP66 without additional sealing (1), provided CMP Installation Fitting Instructions are followed and the threads are 'wrench tight'.

(1) The mating female thread must be machined with the full female thread depth, in compliance with the dimensions and tolerances detailed in the NPT Thread Standard ANSI / ASME B1.20.12013. It should be noted that all female NPT threads of any product supplied by CMP are machined in full compliance with this Standard.

Maintaining the Integrity of the Installation

Sealing Performance

The continuing technical integrity of installations requires significant attention to detail in sealing ring suitability, reliability and functional performance. Three things that can affect this performance include the choice of materials, cable sealing design, and an effective and validated testing programme. Examples of testing include thermal endurance, ingress protection and cable anchorage, twist and pull out resistance tests. CMP Products has excelled in this process and offers the widest temperature rating of any standard cable gland (-60°C to +130°C), CMP Products Cable Glands are 3rd party certified to IEC 62444, IEC 60079, UL 514B and are included in the London Underground register of products. This allows customers to make selection decisions safe in the knowledge that nothing has been left to chance.

The unique CMP Products Seal Tightening Guides (STG) shown below allows the user to determine the number of turns that should be applied to the sealing ring, in order to ensure the correct installation is achieved. The STG also has the added feature of verifying the recommended cable gland size for the section of cable to be used.

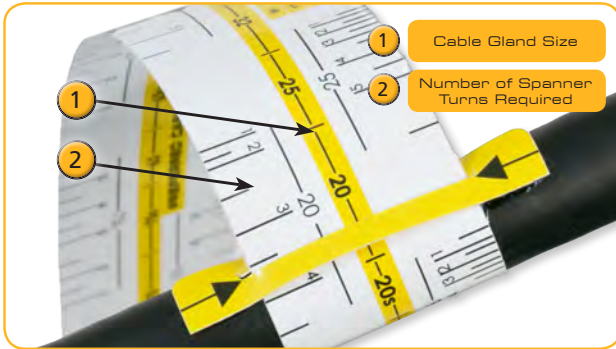

Armour Clamping - Right First Time

The CMP Products armour clamping technique offers a level of reliability, and inspectability, that is unrivalled. The armour cone and AnyWay™ clamping ring are designed to be fully tightened, metal-to-metal, in a 'Right First Time' termination that securely captivates the armour wires in the crimping process. CMP Products Cable Glands' internal armour termination is engineered to secure on installation for the life-time of the product, providing added cable security. They are designed to terminate a range of armour sizes in all available forms including single wire armour, pliable wire armour, wire braid, strip and tape armours. The specific ranges shown on the product pages of this catalogue indicate which armour cone should be used for a given armour type, size and application. CMP Products 'SWA' armour cone clamping ranges closely follow the specified armour wire criteria in IEC 605021, as well as BS & AS/NZS standards. However in cases where the cable is non-standard, alternative armour clamping components for oversized and undersized armour wires are available upon request.

More information on products for use with non-standard armour wire products please see page 10

Reliable Earth Continuity

Potential equalisation, or equipotential bonding, could be adversely affected by cable glands that either do not clamp the armoured cables effectively, or otherwise suffer from self-loosening. The CMP Products armour clamping method ensures that a low impedance termination is created, which does not suffer from self-loosening and in turn facilitates a reliable earth path. As shown below, the armour clamping maintains guaranteed cable security and earth continuity for the life-time of the cable gland.



Maintaining Ingress Protection

CMP Products accessories are available to maintain the Ingress Protection level of the Cable Gland and enclosure.

Parallel Threads - For Explosive Atmospheres, IEC 60079-14 states that when the cable entry is via a parallel threaded hole, it is possible to achieve an ingress protection rating of IP54 without a sealing washer being used, provided always that the threaded enclosure or cable gland plate is a minimum of 6 mm thick, and the axis of the cable entry is perpendicular to the enclosure or cable gland plate.

For enclosures with a parallel threaded hole that require a IP55, IP65 or IP66 level of ingress protection, a CMP Products nylon entry thread sealing washer must be used; without this sealing washer, the desired level of protection is unlikely to be maintained between the Cable Gland and the enclosure. To achieve and maintain ingress protection ratings of IP67 or IP68, a CMP Products nylon entry thread sealing washer must be used and the Cable Gland must be rated for the application (1).

Tapered Threads - When Cable Glands with tapered threads are installed into taper threaded holes, an entry thread sealing washer cannot be fitted due to the conical nature of the thread; IP66 will be maintained with no additional sealing if the connection is 'wrench tight' (2) but to achieve and maintain ingress protection ratings of IP67 or IP68, thread grease must be used on tapered threads and the Cable Gland must be rated for the application (1) (2).

Clearance Holes - Where the cable entry is via a through or punched clearance hole and the application requires an IP54, IP55, IP65 or IP66 level of ingress protection, a CMP Products nylon entry thread sealing washer must be used; without this sealing washer, the desired level of protection is unlikely to be maintained between the Cable Gland and the enclosure. To achieve and maintain ingress protection ratings of IP67 or IP68, a CMP Products nylon entry thread sealing washer must be used and the Cable Gland must be rated for the application (1).

Note: Some CMP products are available with integrated 'O' ring interface seals which perform an identical function to CMP nylon entry thread seals.

For best long term ingress protection performance and integrity CMP Products recommends its nylon entry thread sealing washers. Fibre sealing washers can be supplied upon request but will not perform as well in hostile conditions.

(1) If terminating armoured cable an additional deluge seal is required to protect the armour termination.

(2) The mating female thread must be machined with the full female thread depth, in compliance with the dimensions and tolerances detailed in the NPT Thread Standard ANSI / ASME B1.20.1-2013. It should be noted that all female NPT threads of any product supplied by CMP are machined in full compliance with this Standard.



How to Order

On each of the main Cable Gland product pages in this catalogue you will find a Cable Gland selection table which includes the part number; typically of a standard metric product, for ordering purposes. The part number is composed of the CMP size, type number, and standard suffix. The default material is normally brass and the thread type is metric. The basic part number would reflect this unless one or more suffixes are added to the part number changing the material or the thread type and size, as demonstrated below.

The ordering system shown below is correct for the majority of CMP's Cable Glands (BW, TMC*, TC, **RC, **FC) use an alternative ordering system, please refer to the individual product page.

A CMP Products size 20 T3CDS Cable Gland in nickel plated brass with a 1/2" NPT entry thread ordering example is shown.



Cable Gland Size / Type	Design Options (If applicable)		Supply Type	CMP Suffix		Material	Entry Thread Type		Entry Thread Size***						
									Metric †	NPT BSPP BSPT NPSM	Imperial Electrical Thread (E.T.)	PG ††			
e.g. 20T3CDS	D	Deluge Seal	1	Cable Gland	RA	Standard Cable Gland	0 or **	Brass	**	Metric	1A	3/8"	1/2"	7	
e.g. 40PX2K	C	Cast Integral Earth Lug (CIEL)	2	Cable Gland Pack *	RA/M	Group I Mining Certified Cable Gland	1	Aluminium	1	Imperial Electrical Thread (E.T.)	1	M16	1/2"	5/8"	9
e.g. 50SCW	R	Equipment Interface 'O' Ring Seal			RA/B	Brazilian Certified Cable Gland	2	Nylon	2	PG	2	M20	3/4"	3/4"	11
e.g. 25CXT					RU	Russian Certified Cable Gland	3	Mild Steel	3	NPT	3	M25	1"	1"	13.5
					RD	Supplied with Ingress Disc	4	Stainless Steel	4	BSPP	4	M32	1 1/4"	1 1/4"	16
					RE	Alternative cone for smaller diameter SWA	5	Nickel Plated Brass	5	NPSM	5	M40	1 1/2"	1 1/2"	21
					RB	Alternative cone for larger diameter SWA			6	BSPT	6	M50	2"	2"	29
											7	M63	2 1/2"	2 1/2"	36
											8	M75	3"	3"	42
											9	M90	3 1/2"	3 1/2"	48
											10	M100	4"	4"	
											11	M115			
											12	M130	5"	5"	

Quick How to Order

Size	Type	Standard Suffix	Material	Thread Type	Thread Size
20	T3CDS	1RA	5	3	1
BRASS - METRIC					
NICKEL PLATED BRASS - METRIC					
NICKEL PLATED BRASS - NPT					

* Cable Gland Packs are available with various accessories included providing either one or two terminations per pack. Please contact CMP for further information.
 ** No suffix required when brass metric cable glands are ordered. Digit '0' is only applied to brass product when the thread type is other than metric e.g. 20A2F1RA032
 *** Other thread sizes available upon request.
 † Metric entry thread suffix only applicable to conduit connection cable glands, thread converters and stopper plugs.
 †† PG threads are not included in cable gland standard EN 62444 but may be placed on the market in EU for installation refurbishment or replacement.

Non-Standard Single Armour Wires

CMP also provide alternate cable glands for when the cable armour wires are outside of the standard range.

This is especially true for single wire armour cables (SWA), where a change in the wire size can affect the cable gland selection. IEC 605021 outlines the nominal wire sizes that

should be used in relation to the cable bedding diameter. There are two possible, and different outcomes, when there is a variation in the armour wire thickness, one being a different nominal size of wire is used in the cable manufacture, and another being the nominal wire thickness being over or under size. Details of these alternatives are included in the table below.

Cable Gland Size	Example Ordering Reference*	Armour Range Standard W Cone '1RA'		Armour Range Standard X Cone '1RA'		Armour Range Undersize '1RE'		Armour Range Oversize '1RB'	
		Min	Max	Min	Max	Min	Max	Min	Max
20S16	20S16T3CDS1RA	0.8	1.25	0.3	1.0	0.7	1.15	1.15	1.6
20S	20S16T3CDS1RA	0.8	1.25	0.3	1.0	0.7	1.15	1.15	1.6
20	20T3CDS1RA	0.8	1.25	0.4	1.0	0.7	1.15	1.15	1.6
25S	25S16T3CDS1RA	1.25	1.6	0.4	1.2	0.77	1.22	1.63	2.13
25	25T3CDS1RA	1.25	1.6	0.4	1.2	0.77	1.22	1.63	2.13
32	32T3CDS1RA	1.6	2.0	0.4	1.2	1.12	1.62	2.0	2.6
40	40T3CDS1RA	1.6	2.0	0.4	1.6	1.12	1.62	2.0	2.6
50S	50S16T3CDS1RA	2.0	2.5	0.4	1.6	1.33	2.0	2.4	3.1
50	50T3CDS1RA	2.0	2.5	0.6	1.6	1.33	2.0	2.4	3.1
63S	63S16T3CDS1RA	2.0	2.5	0.6	1.6	1.33	2.0	2.4	3.1
63	63T3CDS1RA	2.0	2.5	0.6	1.6	1.33	2.0	2.4	3.1
75S	75S16T3CDS1RA	2.0	2.5	0.6	1.6	1.33	2.0	2.4	3.1
75	75T3CDS1RA	2.5	3.0	0.6	1.6	1.83	2.53	2.8	3.5
90	90T3CDS1RA	3.15	4.0	0.8	1.6	2.0	3.2	3.6	4.3
100	100T3CDS1RA	3.15	4.0	0.8	1.6	2.0	3.2	3.6	4.3
115	115T3CDS1RA	3.15	4.0	0.8	1.6	2.0	3.2	3.6	4.3
130	130T3CDS1RA	3.15	4.0	0.8	1.6	2.0	3.2	3.6	4.3

All dimension shown are in millimetres unless otherwise stated

*Example ordering reference, T3CDS reference should be replaced by ordered Cable Gland. 1RA suffix should be replaced with reference depending on armour size needed

Cable Gland Examples	Armour Range Standard W Cone '1RA'	Armour Range Standard X Cone '1RA'	Armour Range Undersize '1RE'	Armour Range Oversize '1RB'
CW / CX	20CW1RA	20CX1RA	20CW1RE	20CW1RB
E1U	20E1U1RA	20E1U1RA	20E1U1RE	20E1U1RB
E1FW / E1FX	20E1FW1RA	20E1FX1RA	20E1FW1RE	20E1FW1RB
PX2K	20PX2K1RA	20PX2K1RA	20PX2K1RE	20PX2K1RB
PX2KREX	20PX2KREX1RA	20PX2KREX1RA	20PX2KREX1RE	20PX2KREX1RB
T3CDS	20T3CDS1RA	20T3CDS1RA	20T3CDS1RE	20T3CDS1RB

Brass M20 shown as example

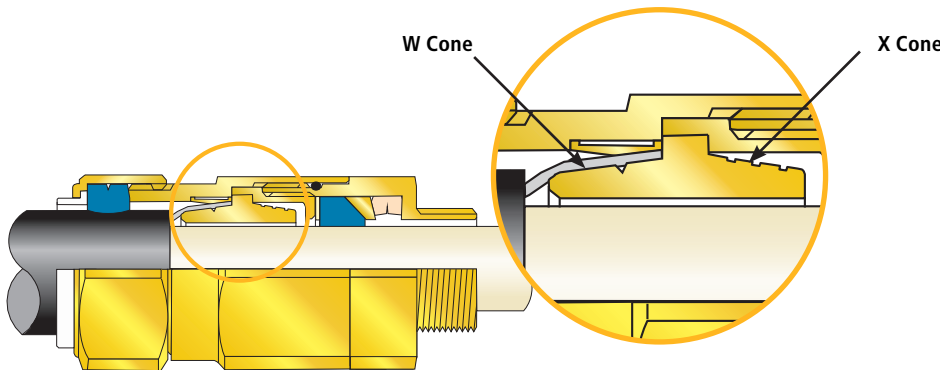

CMP T3CDS Cable Gland showing reversible armour cone (available in all universal CMP armoured cable glands)



Cable Gland & Enclosure Material Selection

The specific conditions of any installation will play a major part in the selection of the Cable Gland material, taking into account the level of environmental exposure along with the nature of the enclosure and cable armour material.

The following table is offered as a CMP guide to operations under normal conditions. Subject to there being no adverse environmental conditions, this table can be used to determine the Cable Gland (or Adaptor) material recommended by CMP.

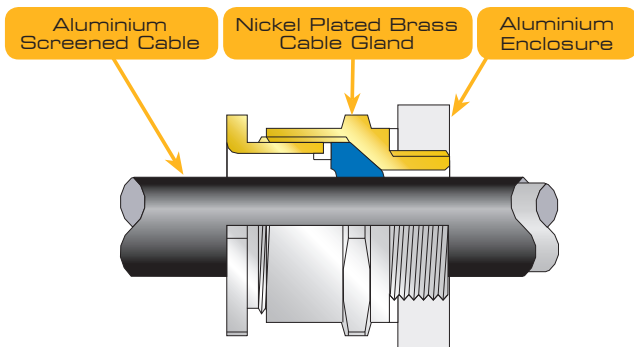

Typical feedthrough cable arrangement

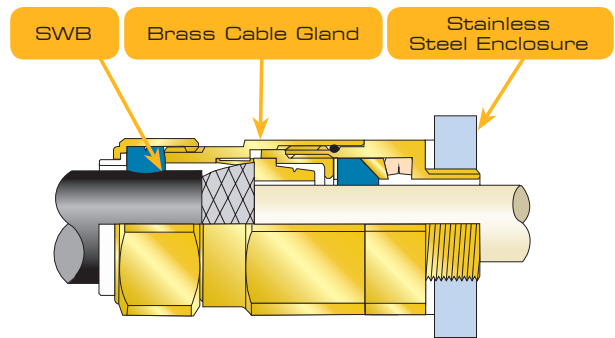

Typical metallic cable layer in contact with cable gland

		Enclosure / Gland Plate Material				
		Aluminium	Brass	Stainless Steel	Steel	Non-Metallic
Cable Type	Feedthrough Cable Arrangement*	Suggested Cable Gland / Adaptor material options				
	Unarmoured e.g. PVC/XLPE, or any screened cable with metallic screen					
	Metallic Cable Layers in contact with Cable Gland	Suggested Cable Gland / Adaptor material options				
	Aluminium Armour e.g. AWA, ASA, ATA					
	Steel Armour e.g. GSWA, SWA, STA					
	Steel Wire Braid e.g. SWB, GSWB					
	Stainless Steel Wire Braid e.g. SSWB					
	Bronze Wire Armour / Braid e.g. BWB					
	Brass Tape, Screen or Armour					
	Copper Screen e.g. CWB, TCWB, CTS, CWS					



* This feedthrough arrangement would involve the whole cable passing inside the enclosure without any metallic layers being in contact with the cable gland. Any screens or other metallic layers needing to be earthed would be earthed or grounded inside the enclosure.



Industrial Cable Gland Matrix

CABLE TYPES

Cable Gland Type	Page	Unarmoured Cables				Armoured Cables			
		Normal	Lead Sheathed	Conduit Connection	Flat Form Cable	Single Wire Armour**	Wire Braid	Steel Tape Armour	
UNARMOURED	A2	23	Yes	No	No	No	No	No	No
	A2RC	24	Yes	No	Yes	No	No	No	No
	SS2KGP	26	Yes	No	No	No	No	No	No
	SS2KGPPB	27	Yes	Yes	No	No	No	No	No
	A2FF	112	Yes	No	No	Yes	No	No	No
SWA & AWA	BW	18	No	No	No	Yes	No	No	No
	BWL	19	No	No	No	Yes	No	No	No
	C2KGP	20	No	No	No	Yes	Yes	Yes	No
	CW	21	No	No	No	Yes	No	No	No
	E1U	28	No	No	No	Yes	Yes	Yes	No
	E2U	29	No	No	No	Yes	Yes	Yes	No
	E1W	30	No	No	No	Yes	No	No	No
	E2W	31	No	No	No	Yes	No	No	No
BRAIDS & TAPES	C2KGP	20	No	No	No	Yes	Yes	Yes	No
	CX	22	No	No	No	Yes	Yes	Yes	No
	CXT	25	No	No	No	No	Yes	No	No
	E1U	28	No	No	No	Yes	Yes	Yes	No
	E2U	29	No	No	No	Yes	Yes	Yes	No
	E1X	32	No	No	No	Yes	Yes	Yes	No
	E2X	33	No	No	No	Yes	Yes	Yes	No



STANDARD OPTION

FEATURES

			Sealing Technique				High Temperature Option Available	Environmental Protection			
Strip Armour	Pliable Wire Armour	Lead Sheathed	No Seal	Inner Seal	Outer Seal	Deluge 'O' Ring Seal		IP66	IP67	IP68*	Certified Deluge Proof
					STANDARD		OPTION	STANDARD	STANDARD	STANDARD	STANDARD
					STANDARD			STANDARD			
					STANDARD	STANDARD		STANDARD	STANDARD	STANDARD	STANDARD
					STANDARD	STANDARD		STANDARD	STANDARD	STANDARD	STANDARD
						STANDARD		OPTION	STANDARD	STANDARD	STANDARD
				STANDARD							
				STANDARD							
	STANDARD	STANDARD				STANDARD		STANDARD	STANDARD	STANDARD	STANDARD
								STANDARD	OPTION	OPTION	OPTION
	STANDARD	STANDARD			STANDARD			STANDARD	OPTION	OPTION	OPTION
	STANDARD	STANDARD	STANDARD		STANDARD			STANDARD	OPTION	OPTION	OPTION
					STANDARD			STANDARD	OPTION	OPTION	OPTION
		STANDARD			STANDARD			STANDARD	OPTION	OPTION	OPTION
	STANDARD	STANDARD						STANDARD	OPTION	OPTION	OPTION
	STANDARD	STANDARD						STANDARD	OPTION	OPTION	OPTION
	STANDARD	STANDARD	STANDARD		STANDARD			STANDARD	OPTION	OPTION	OPTION

* IP68 ratings are qualified with depth of water and duration of test. Please refer to individual product pages
 ** Single Wire Armour includes both Steel Wire Armour and Aluminium Wire Armour



Explosive Atmosphere Cable Gland Matrix

CMP PRODUCTS CABLE GLAND SELECTION

CABLE TYPES

Cable Gland Type	Page	Unarmoured Cables					Armoured Cables						
		Normal	Lead Sheathed	Conduit Connection	Flexible Conduit Connection	Hose Connection	Flat Form Cable	Single Wire Armour**	Wire Braid	Steel Tape Armour	Strip Armour		
UNARMOURED	A2F	62											
	A2FRC	67											
	A2FFC	66											
	A2E	63											
	RA2E	64											
	SS2K	68											
	SS2KTA (Tape Armour Gland)	70											
	SS2KPB	69											
	PXSS2K	BARRIER	98										
	PXRC		99										
	PXSS2KREX		89										
	PXRCREX		91										
	PXSS2KHCREX***		90										
	A2FFF		113										
A2FHC***	119												
SWA & AWA	T3CDS	54											
	T3CDSPB	57											
	C2K	71											
	CWe	73											
	TE1FU	74											
	TE1FUPB	75											
	E1FU	76											
	E2FU	77											
	E1FW	80											
	E2FW	81											
	PX2K	BARRIER	94										
	PX2KW		96										
	PX2KPB		97										
	PX2KREX		85										
PX2KWREX	86												
BRAIDS & TAPES	T3CDS	54											
	T3CDSPB	57											
	C2K	71											
	CXe	72											
	TE1FU	74											
	TE1FUPB	75											
	E1FU	76											
	E2FU	77											
	E1FX	78											
	E2FX	79											
	C2KX	143											
	PX2K	BARRIER	94										
	PX2KX		95										
	PX2KPB		97										
PX2KREX	85												
PX2KXREX	87												

DELUGE PROTECTED EXPLOSIVE ATMOSPHERE
 EXPLOSIVE ATMOSPHERE
 BARRIER



STANDARD

OPTION

FEATURES

	Sealing Technique								High Temperature Option Available	Environmental Protection				Ex d IIC Gb	Ex e IIC Gb	Ex nR IIC Gc	Ex ta IIC Da
	Pliable Wire Armour	Lead Sheathed	Inner Seal	Inner Compensating Displacement Seal	Outer Seal	Epoxy Barrier Seal	RapidEx Liquid Resin Seal	Deluge 'O' Ring Seal		IP66	IP67	IP68	Certified Deluge Proof				
					Standard				Option	Standard	Standard	Standard	Standard	Standard	Standard	Standard	
					Standard					Standard	Standard	Standard	Standard	Standard	Standard	Standard	
					Standard					Standard	Standard	Standard	Standard	Standard	Standard	Standard	
					Standard					Standard	Standard	Standard	Standard	Standard	Standard	Standard	
					Standard	Standard		Standard		Standard	Standard	Standard	Standard	Standard	Standard	Standard	
					Standard	Standard		Standard		Standard	Standard	Standard	Standard	Standard	Standard	Standard	
					Standard	Standard		Standard		Standard	Standard	Standard	Standard	Standard	Standard	Standard	
					Standard	Standard		Standard		Standard	Standard	Standard	Standard	Standard	Standard	Standard	
	Standard		Standard		Standard			Standard	Option	Standard	Standard	Standard	Standard	Standard	Standard	Standard	
	Standard		Standard		Standard			Standard	Option	Standard	Standard	Standard	Standard	Standard	Standard	Standard	
	Standard		Standard		Standard			Standard	Option	Standard	Standard	Standard	Standard	Standard	Standard	Standard	
	Standard		Standard		Standard			Standard	Option	Standard	Standard	Standard	Standard	Standard	Standard	Standard	
	Standard	Standard			Standard	Standard		Standard		Standard	Standard	Standard	Standard	Standard	Standard	Standard	
	Standard	Standard			Standard	Standard		Standard		Standard	Standard	Standard	Standard	Standard	Standard	Standard	
	Standard	Standard			Standard	Standard		Standard		Standard	Standard	Standard	Standard	Standard	Standard	Standard	
	Standard	Standard			Standard	Standard		Standard		Standard	Standard	Standard	Standard	Standard	Standard	Standard	
	Standard		Standard		Standard			Standard	Option	Standard	Standard	Standard	Standard	Standard	Standard	Standard	
	Standard		Standard		Standard			Standard	Option	Standard	Standard	Standard	Standard	Standard	Standard	Standard	
	Standard		Standard		Standard			Standard	Option	Standard	Standard	Standard	Standard	Standard	Standard	Standard	
	Standard		Standard		Standard			Standard	Option	Standard	Standard	Standard	Standard	Standard	Standard	Standard	
	Standard	Standard			Standard	Standard		Standard		Standard	Standard	Standard	Standard	Standard	Standard	Standard	
	Standard	Standard			Standard	Standard		Standard		Standard	Standard	Standard	Standard	Standard	Standard	Standard	
	Standard	Standard			Standard	Standard		Standard		Standard	Standard	Standard	Standard	Standard	Standard	Standard	
	Standard	Standard			Standard	Standard		Standard		Standard	Standard	Standard	Standard	Standard	Standard	Standard	
	Standard		Standard		Standard			Standard	Option	Standard	Standard	Standard	Standard	Standard	Standard	Standard	
	Standard		Standard		Standard			Standard	Option	Standard	Standard	Standard	Standard	Standard	Standard	Standard	
	Standard		Standard		Standard			Standard	Option	Standard	Standard	Standard	Standard	Standard	Standard	Standard	
	Standard		Standard		Standard			Standard	Option	Standard	Standard	Standard	Standard	Standard	Standard	Standard	

CMP PRODUCTS CABLE GLAND SELECTION

* IP68 ratings are qualified with depth of water and duration of test. Please refer to individual product pages
 ** Single Wire Armour includes both Steel Wire Armour and Aluminium Wire Armour
 ***When used in Group II (over ground)





Industrial Cable Glands

The CMP Products range of Industrial Cable Glands embraces products used in a wide and diverse variety of market sectors, in conjunction with virtually every kind of industrial cable installation. With a wealth of experience in terminating all types of armoured and unarmoured cables CMP understands that when it comes to such critical installations, quality and reliability really do count.

CMP Cable Gland options for all types of cables are available in a wide range of sizes and are supplied in a variety of thread forms. Cable glands are available in various materials including Brass, Electroless Nickel Plated Brass, Aluminium and Stainless Steel. Significantly the brass grade used in the production of all CMP brass Cable Glands is CuZn39Pb3 (CW614N) to BS EN 12164:2011 / BS EN 12168:2011.

CMP Products designs and manufactures Cable Glands and Accessories conforming to the prevailing industry standards including EN 62444, IEC 62444 and the more rigorous BS6121:Part 1:1989. CMP Products holds a host of internationally recognised approvals, and it's product range is manufactured under a 3rd party approved Quality Management System conforming to ISO 9001:2008.

All Cable Glands shown in Nickel Plated Brass, alternative materials are available.

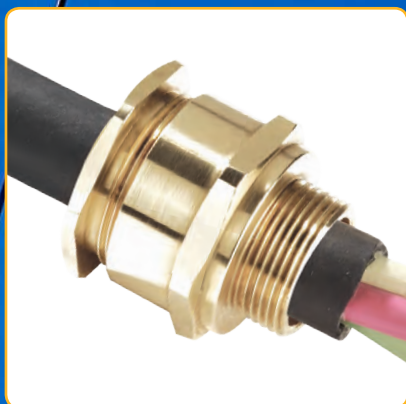

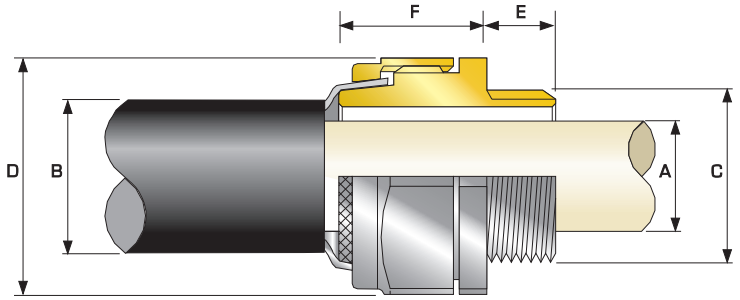

BW

BW Industrial Cable Gland

For all types of Steel & Aluminium Wire Armoured Cables

- High quality durable materials
- Simple, effective two part arrangement
- Direct & remote installation
- Permanently crimped, low impedance earth termination
- Secure against self-loosening
- -60°C to +200°C
- Superior EMC performance



TECHNICAL DATA	
Design Specification	BS 6121:Part 1:1989
Mechanical Classifications*	Impact = Level 8, Cable Anchorage = Class D
Enclosure Protection	IK10 to IEC 62262 (20 joules)
Electrical Classifications*	Category B
Marine Approvals	LRS: 01/00171 (E1), ABS: 16-LD1472056-PDA
GOST R Certificate	POCC GB.AF35.H00102
Continuous Operating Temperature	-60°C to +200°C
Ingress Protection Rating**	IP2X
Cable Gland Material	Brass, Electroless Nickel Plated Brass
Cable Type	Single Wire Armour (SWA), Aluminium Wire Armour (AWA)
Armour Clamping	Two Part Armour Lock
Cable Gland Kits Available	Cable Gland Kit for use with all types of SWA cable, including 2 Brass Cable Glands, 2 Steel Locknuts, 2 Brass Earth Tags and 2 PVC Shrouds for sizes up to and including 32mm. For sizes 40mm and above each kit includes 1 of each component.

* Mechanical & Electrical Classifications applied as per IEC 62444 & EN 62444
 As IEC 62444 and EN 62444 do not cover cable glands which are supplied without cable sealing rings, the information provided here is for information only.
 ** When CMP installation accessories are used. Refer to page 7 or www.cmp-products.com for further information.

Cable Gland Selection Table

Refer to illustration at the top of the page.

Cable Gland Size	Available Entry Threads "C" (Alternate Metric Thread Lengths Available)		Cable Bedding Diameter "A" Max	Overall Cable Diameter "B" Max	Armour Range		Across Flats "D" Max	Across Corners "D" Max	Protusion Length "F" Max	Combined Ordering Reference (*Brass Metric)			Shroud	Cable Gland Weight (Kgs)
	Metric	Thread Length (Metric) "E"			Min	Max				Size	Type	Ordering Suffix		
20S	M20	10.0	11.7	15.8	0.8	1.25	22.0	24.2	18.5	20S	BW	1AA	PVC04	0.052
20	M20	10.0	14.0	21.1	0.8	1.25	28.0	30.8	22.5	20	BW	1AA	PVC05	0.088
25	M25	10.0	20.0	27.2	1.25	1.6	33.0	36.3	21.5	25	BW	1AA	PVC07	0.110
32	M32	10.0	26.3	34.1	1.6	2.0	41.0	45.1	22.5	32	BW	1AA	PVC10	0.149
40	M40	15.0	32.2	42.4	1.6	2.0	50.0	55.0	30.0	40	BW	1AA	PVC13	0.316
50S	M50	15.0	38.2	50.1	2.0	2.5	57.1	62.8	30.0	50S	BW	1AA	PVC16	0.468
50	M50	15.0	44.1	55.7	2.0	2.5	65.0	71.5	32.0	50	BW	1AA	PVC19	0.477
63S	M63	15.0	50.0	62.4	2.0	2.5	75.0	82.5	41.3	63S	BW	1AA	PVC23	0.632
63	M63	15.0	56.0	68.2	2.0	2.5	79.0	86.9	41.3	63	BW	1AA	PVC24	0.890
75S	M75	15.0	62.0	76.8	2.0	2.5	89.0	97.9	47.6	75S	BW	1AA	PVC27	1.268
75	M75	15.0	68.0	82.9	2.5	3.0	95.0	104.5	49.6	75	BW	1AA	PVC29	1.400

*For material options add the following suffix to the Ordering Reference; Brass (no suffix required); Nickel Plated Brass 'S'

Example: 32BW1RAS = Nickel Plated Brass

Dimensions are displayed in millimetres unless otherwise stated

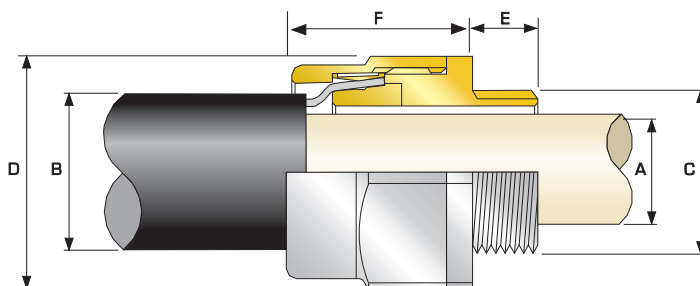

BWL

BWL Heavy Duty Industrial Cable Gland

For all types of Steel & Aluminium Wire Armoured Cables

- High quality durable materials
- Simple, effective two part arrangement
- Metal-to-metal armour clamping
- Direct & remote installation
- Permanently crimped, low impedance earth termination
- Secure against self-loosening
- Robust, heavy duty design
- Longer body protects armour wires from impact
- -60°C to +200°C
- Superior EMC performance

TECHNICAL DATA	
Design Specification	BS 6121: Part 1: 1989
Mechanical Classifications*	Impact = Level 8, Cable Anchorage = Class D
Enclosure Protection	IK10 to IEC 62262 (20 joules)
Electrical Classifications*	Category B
Marine Approvals	LRS: 01/00171 (E1), ABS: 16-LD1472056-PDA
GOST R Certificate	POCC GB.AГ35.H00102
Continuous Operating Temperature	-60°C to +200°C
Ingress Protection Rating**	IP2X
Cable Gland Material	Brass, Electroless Nickel Plated Brass
Cable Type	Single Wire Armour (SWA), Aluminium Wire Armour (AWA)
Armour Clamping	Detachable Armour Cone & AnyWay Universal Clamping Ring



* Mechanical & Electrical Classifications applied as per IEC 62444 & EN 62444
 As IEC 62444 and EN 62444 do not cover cable glands which are supplied without cable sealing rings, the information provided here is for information only.

** When CMP installation accessories are used. Refer to page 7 or www.cmp-products.com for further information.

Cable Gland Selection Table

Refer to illustration at the top of the page.

Cable Gland Size	Available Entry Threads "C" (Alternate Metric Thread Lengths Available)		Cable Bedding Diameter "A"	Overall Cable Diameter "B"	Armour Range		Across Flats "D"	Across Corners "D"	Protrusion Length "F"	Combined Ordering Reference (*Brass Metric)			Shroud	Cable Gland Weight (Kgs)
	Metric	Thread Length (Metric) "E"			Max	Max				Min	Max	Max		
20S16	M20	10.0	8.7	13.2	0.8	1.25	24.0	26.4	35.2	20S16	BWL	1RA	PVC04	0.084
20S	M20	10.0	11.7	15.9	0.8	1.25	24.0	26.4	32.2	20S	BWL	1RA	PVC04	0.076
20	M20	10.0	14.0	20.9	0.8	1.25	30.5	33.6	30.6	20	BWL	1RA	PVC06	0.117
25	M25	10.0	20.0	26.2	1.25	1.6	36.0	39.6	36.4	25	BWL	1RA	PVC09	0.155
32	M32	10.0	26.3	33.9	1.6	2.0	46.0	50.6	32.6	32	BWL	1RA	PVC11	0.220
40	M40	15.0	32.2	40.4	1.6	2.0	55.0	60.5	36.6	40	BWL	1RA	PVC15	0.370
50S	M50	15.0	38.2	46.7	2.0	2.5	60.0	66.0	39.6	50S	BWL	1RA	PVC18	0.468
50	M50	15.0	44.1	53.1	2.0	2.5	70.1	77.1	39.1	50	BWL	1RA	PVC21	0.434
63S	M63	15.0	50.0	59.4	2.0	2.5	75.0	82.5	52.0	63S	BWL	1RA	PVC23	0.846
63	M63	15.0	56.0	65.9	2.0	2.5	80.0	88.0	49.8	63	BWL	1RA	PVC25	0.818
75S	M75	15.0	62.0	72.1	2.0	2.5	90.0	99.0	63.7	75S	BWL	1RA	PVC28	1.486
75	M75	15.0	68.0	78.5	2.5	3.0	100.0	110.0	57.3	75	BWL	1RA	PVC30	1.662
90	M90	24.0	80.0	90.4	3.15	4.0	114.3	125.7	66.6	90	BWL	1RA	PVC32	2.460

*For material options add the following suffix to the Ordering Reference, Brass (no suffix required), Nickel Plated Brass '5'

Example: 32BWL1RA5 = Nickel Plated Brass

Dimensions are displayed in millimetres unless otherwise stated

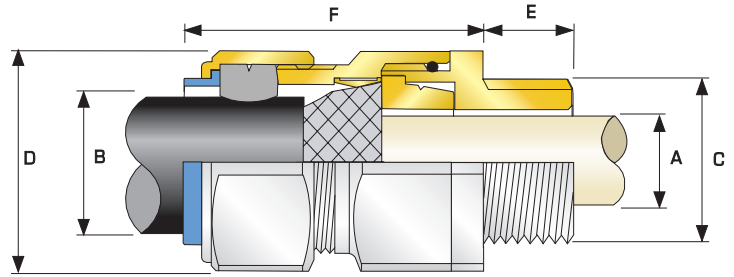

C2KGP

C2KGP Single Seal Industrial Cable Gland

For all types of Armoured Cables

- High quality durable materials
- Robust, heavy duty design
- Metal-to-metal armour clamping
- Direct & remote installation
- Controlled outer 'load retention' seal
- Unique OSTG prevents overtightening
- Integral protected deluge seal
- -60°C to +130°C
- Superior EMC performance



† Grooved Cone (X) is predominantly used for Wire Braid (e.g. GSWB, TCWB), Steel Tape Armour (STA, DSTA) and Aluminium Strip Armour (ASA) but is also suitable for Single Wire Armour (SWA), Aluminium Wire Armour (AWA) and Pliable Wire Armour (PWA) if the range is outside that of the Stepped Cone (W).

Grooved Cone (X) dimensions shown in the Cable Gland Selection Table below are for a double wire strand of braid armour cables. Tapes can also be doubled over. For cables that have only a single layer of armour such as SWA the clamping range should be used as shown in the table below.

Stepped (W) Cone is suitable for Single Wire Armour (SWA), or Aluminium Wire Armour (AWA) cables.

TECHNICAL DATA

Design Specification	BS 6121:Part 1:1989, IEC 62444, EN 62444
Mechanical Classifications*	Impact = Level 8, Cable Anchorage = Class D
Enclosure Protection	IK10 to IEC 62262 (20 joules) Brass & Stainless Steel only
Electrical Classifications*	Category B (Category A when used with braid, tape or pliable wire armour cables)
Marine Approvals	LRS: 01/00171 (E1)
GOST R Certificate	POCC GB.AF35.H00102
Ingress Protection Rating**	IP66, IP67 & IP68***
Deluge Protection Compliance	DTS01 : 91
Cable Gland Material	Brass, Electroless Nickel Plated Brass, Stainless Steel, Aluminium
Seal Material	CMP Thermoset Rubber
Cable Type	Single Wire Armour (SWA), Aluminium Wire Armour (AWA), Steel Tape Armour (STA), Aluminium Strip Armour (ASA), Wire Braid Armour, Screened Flexible (EMC) Wire Braid (e.g. CY / SY), Pliable Wire Armour (PWA)
Armour Clamping	Reversible Armour Cone & AnyWay Universal Clamping Ring
Sealing Technique	Unique CMP 'LRS' Outer Seal (Load Retention Seal)
Sealing Area(s)	Cable Outer Sheath

* Mechanical & Electrical Classifications applied as per IEC 62444 & EN 62444

** When CMP installation accessories are used. Refer to page 7 or www.cmp-products.com for further information.

*** IP68 tested to a minimum depth of 30 metres for 12 hours, alternate depths / durations can be provided upon request

Cable Gland Selection Table

Refer to illustration at the top of the page.

Dimensions listed below are for metric cable glands only
Dimensions for alternative threads may vary, please see supplementary technical data sheet

Cable Gland Size	Available Entry Threads "C" (Alternate Metric Thread Lengths Available)		Cable Bedding Diameter "A"	Overall Cable Diameter "B"			Armour Range †				Across Flats "D"	Across Corners "D"	Protrusion Length "F"	Combined Ordering Reference (*Brass Metric)			Shroud	Cable Gland Weight (Kgs)
	Metric	Thread Length (Metric) "E"		Max	Min	Max	Grooved Cone (X)		Stepped Cone (W)					Size	Type	Ordering Suffix		
							Min	Max	Min	Max								
20S16	M20	10.0	8.7	6.1	13.1	0.3	1.0	0.8	1.25	30.5	33.6	65.0	20S16	C2KGP	1RA	PVC06	0.23	
20S	M20	10.0	11.7	9.5	15.9	0.3	1.0	0.8	1.25	30.5	33.6	62.0	20S	C2KGP	1RA	PVC06	0.22	
20	M20	10.0	14.0	12.5	20.9	0.4	1.0	0.8	1.25	30.5	33.6	63.0	20	C2KGP	1RA	PVC06	0.22	
25S	M25	10.0	20.0	14.0	22.0	0.4	1.2	1.25	1.6	37.5	41.3	69.5	25S	C2KGP	1RA	PVC09	0.35	
25	M25	10.0	20.0	18.2	26.2	0.4	1.2	1.25	1.6	37.5	41.3	69.5	25	C2KGP	1RA	PVC09	0.35	
32	M32	10.0	26.3	23.7	33.9	0.4	1.2	1.6	2.0	46.0	50.6	75.0	32	C2KGP	1RA	PVC11	0.55	
40	M40	15.0	32.2	27.9	40.4	0.4	1.6	1.6	2.0	55.0	60.5	75.0	40	C2KGP	1RA	PVC15	0.75	
50S	M50	15.0	38.2	35.2	46.7	0.4	1.6	2.0	2.5	60.0	66.0	77.0	50S	C2KGP	1RA	PVC18	0.86	
50	M50	15.0	44.1	40.4	53.0	0.6	1.6	2.0	2.5	70.1	77.1	77.0	50	C2KGP	1RA	PVC21	1.13	
63S	M63	15.0	50.0	45.6	59.4	0.6	1.6	2.0	2.5	75.0	82.5	80.0	63S	C2KGP	1RA	PVC23	1.33	
63	M63	15.0	56.0	54.6	65.8	0.6	1.6	2.0	2.5	80.0	88.0	80.0	63	C2KGP	1RA	PVC25	1.34	
75S	M75	15.0	62.0	59.0	72.0	0.6	1.6	2.0	2.5	90.0	99.0	87.0	75S	C2KGP	1RA	PVC28	2.02	
75	M75	15.0	68.0	66.7	78.4	0.6	1.6	2.5	3.0	100.0	110.0	88.0	75	C2KGP	1RA	PVC30	2.48	
90	M90	24.0	80.0	76.2	90.3	0.8	1.6	3.15	4.0	115.0	126.5	102.0	90	C2KGP	1RA	PVC32	3.52	
100	M100	24.0	91.0	86.1	101.4	0.8	1.6	3.15	4.0	127.0	139.7	114.0	100	C2KGP	1RA	LSF33	4.57	
115	M115	24.0	98.0	101.5	110.2	0.8	1.6	3.15	4.0	133.4	146.7	114.0	115	C2KGP	1RA	LSF34	6.50	
130	M130	24.0	115.0	110.2	123.2	0.8	1.6	3.15	4.0	152.4	167.6	114.0	130	C2KGP	1RA	LSF35	8.50	

*For material options add the following suffix to the Ordering Reference; Brass (no suffix required); Nickel Plated Brass 'S'; 316 Grade Stainless Steel '4'; Copper Free Aluminium '1' For NPT options please add the following digits to the material suffix; 1/2" = 31, 3/4" = 32, 1" = 33, 1 1/4" = 34, 1 1/2" = 35, 2" = 36, 2 1/2" = 37, 3" = 38, 3 1/2" = 39, 4" = 310 (Brass requires prefix "0")

Examples: 32C2KGP1RA534 = Nickel Plated Brass 1 1/4" NPT, 50S2C2KGP1RA035 = Brass 1 1/2" NPT, 25C2KGP1RA432 = Stainless Steel 3/4" NPT, 20C2KGP1RA5 = Nickel Plated Brass M20

Dimensions are displayed in millimetres unless otherwise stated

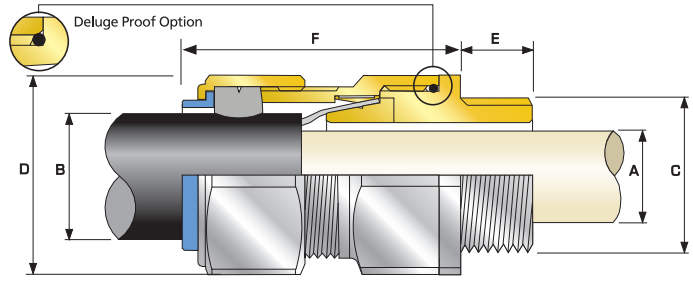

CW

CW Single Seal Industrial Cable Gland

For all types of Steel & Aluminium Wire Armoured Cables

- High quality durable materials
- Robust, heavy duty design
- Metal-to-metal armour clamping
- Direct & remote installation
- Controlled outer 'load retention' seal
- Unique OSTG prevents overtightening
- -60°C to +130°C (standard), -20°C to 200°C (Thermln option page 91)
- Deluge protection option
- Superior EMC performance



Deluge Proof option available (CWD)

TECHNICAL DATA	
Design Specification	BS 6121:Part 1:1989, IEC 62444, EN 62444
Mechanical Classifications*	Impact = Level 8, Cable Anchorage = Class D
Enclosure Protection	IK10 to IEC 62262 (20 joules) Brass & Stainless Steel only
Electrical Classifications*	Category B
Marine Approvals	LRS: 01/00171 (E1), ABS: 16-LD1472056-PDA
GOST R Certificate	POCC GB.AF35.H00102
Ingress Protection Rating**	IP66 as standard (IP67, IP68*** available upon request)
Cable Gland Material	Brass, Electroless Nickel Plated Brass, Stainless Steel, Aluminium
Seal Material	CMP Thermoset Rubber
Cable Type	Single Wire Armour (SWA), Aluminium Wire Armour (AWA)
Armour Clamping	Detachable Armour Cone & AnyWay Universal Clamping Ring
Sealing Technique	Unique CMP 'LRS' Outer Seal (Load Retention Seal)
Sealing Area(s)	Cable Outer Sheath
Cable Gland Kits Available	Cable Gland kit for use with all types of SWA cable including 2 Brass Cable Glands, 2 Steel Locknuts, 2 Brass Earth Tags and 2 PVC Shrouds for sizes up to and including 32mm. For sizes 40mm and above each kit includes 1 of each component.

* Mechanical & Electrical Classifications applied as per IEC 62444 & EN 62444
 ** When CMP installation accessories are used. Refer to page 7 or www.cmp-products.com for further information.
 *** IP68 tested to a minimum depth of 30 metres for 12 hours, alternate depths / durations can be provided upon request

Cable Gland Selection Table

Refer to illustration at the top of the page.

Dimensions listed below are for metric cable glands only
 Dimensions for alternative threads may vary, please see supplementary technical data sheet

Cable Gland Size	Available Entry Threads "C" (Alternate Metric Thread Lengths Available)				Cable Bedding Diameter "A"	Overall Cable Diameter "B"			Armour Range		Across Flats "D"	Across Corners "D"	Protrusion Length "F"	Combined Ordering Reference (*Brass Metric)			Shroud	Cable Gland Weight (Kgs)		
	Standard		Option			Max	Min	Max	Min	Max				Max	Max	Size			Type	Ordering Suffix
	Metric	Thread Length (Metric) "E"	NPT	Thread Length (NPT) "E"																
20S16	M20	10.0	1/2"	19.9	3/4"	8.7	6.1	13.1	0.8	1.25	24.0	26.4	48.0	20S16	CW	1RA	PVC04	0.100		
20S	M20	10.0	1/2"	19.9	3/4"	11.7	9.5	15.9	0.8	1.25	24.0	26.4	48.0	20S	CW	1RA	PVC04	0.140		
20	M20	10.0	1/2"	19.9	3/4"	14.0	12.5	20.9	0.8	1.25	30.5	33.6	48.0	20	CW	1RA	PVC06	0.180		
25S	M25	10.0	3/4"	20.2	1"	20.0	14.0	22.0	1.25	1.6	37.5	41.3	56.0	25S	CW	1RA	PVC09	0.257		
25	M25	10.0	3/4"	20.2	1"	20.0	18.2	26.2	1.25	1.6	37.5	41.3	56.0	25	CW	1RA	PVC09	0.257		
32	M32	10.0	1"	25.0	1 1/4"	26.0	23.7	33.9	1.6	2.0	46.0	50.6	54.0	32	CW	1RA	PVC11	0.376		
40	M40	15.0	1 1/4"	25.6	1 1/2"	32.2	27.9	40.4	1.6	2.0	55.0	60.5	58.0	40	CW	1RA	PVC15	0.630		
50S	M50	15.0	1 1/2"	26.1	2"	38.2	35.2	46.7	2.0	2.5	60.0	66.0	61.0	50S	CW	1RA	PVC18	0.757		
50	M50	15.0	2"	26.9	2 1/2"	44.1	40.4	53.0	2.0	2.5	70.1	77.1	60.0	50	CW	1RA	PVC21	0.862		
63S	M63	15.0	2"	26.9	2 1/2"	50.0	45.6	59.4	2.0	2.5	75.0	82.5	74.0	63S	CW	1RA	PVC23	1.390		
63	M63	15.0	2 1/2"	39.9	3"	56.0	54.6	65.8	2.0	2.5	80.0	88.0	71.0	63	CW	1RA	PVC25	1.360		
75S	M75	15.0	2 1/2"	39.9	3"	62.0	59.0	72.0	2.0	2.5	90.0	99.0	86.0	75S	CW	1RA	PVC28	2.307		
75	M75	15.0	3"	41.5	3 1/2"	64.2	66.7	78.4	2.5	3.0	100.0	110.0	82.0	75	CW	1RA	PVC30	2.909		
90	M90	24.0	3 1/2"	42.8	4"	78.6	76.2	90.3	3.15	4.0	114.3	125.7	95.0	90	CW	1RA	PVC32	3.858		
100	M100	24.0	4"	44.0	5"	91.0	86.1	101.4	3.15	4.0	123.0	135.3	95.0	100	CW	1RA	LSF33	4.958		
115	M115	24.0	4"	44.0	5"	98.0	101.5	110.2	3.15	4.0	133.4	146.7	107.5	115	CW	1RA	LSF34	5.058		
130	M130	24.0	5"	46.8	-	115.0	110.2	123.2	3.15	4.0	152.4	167.6	110.0	130	CW	1RA	LSF35	6.158		

* For material options add the following suffix to the Ordering Reference; Brass (no suffix required), Nickel Plated Brass '5', 316 Grade Stainless Steel '4', Copper Free Aluminium '1'
 For NPT options please add the following digits to the material suffix; 1/2" = 31, 3/4" = 32, 1" = 33, 1 1/4" = 34, 1 1/2" = 35, 2" = 36, 2 1/2" = 37, 3" = 38, 3 1/2" = 39, 4" = 310 (Brass requires prefix "0")

Examples: 20CW1RA5 = Nickel Plated Brass M20, 50CW1RA = Brass 50mm, 25CW1RA4 = Stainless Steel 25mm

Dimensions are displayed in millimetres unless otherwise stated

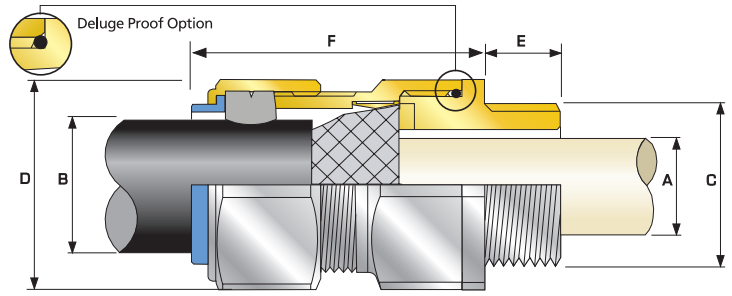

CX

CX Single Seal Industrial Cable Gland

For Braided & Steel Tape Armoured Cables

- High quality durable materials
- Robust, heavy duty design
- Metal-to-metal armour clamping
- Direct & remote installation
- Controlled outer 'load retention' seal
- Unique OSTG prevents overtightening
- -60°C to +130°C (standard), -20°C to 200°C (ThermIn option page 91)
- Deluge protection option
- Superior EMC performance



† Grooved Cone (X) is predominantly used for Wire Braid (e.g. GSWB, TCWB), Steel Tape Armour (STA, DSTA) and Aluminium Strip Armour (ASA) but is also suitable for Single Wire Armour (SWA), Aluminium Wire Armour (AWA) and Pliable Wire Armour (PWA) if the range is outside that of the Stepped Cone (W).

Grooved Cone (X) dimensions shown in the Cable Gland Selection Table below are for a double wire strand of braid armour cables. Tapes can also be doubled over, for cables that have only a single layer of armour such as SWA the clamping range should be used as shown in the table below.

TECHNICAL DATA

Design Specification	BS 6121:Part 1:1989, IEC 62444, EN 62444
Mechanical Classifications*	Impact = Level 8, Cable Anchorage = Class D
Enclosure Protection	IK10 to IEC 62262 (20 joules) Brass & Stainless Steel only
Electrical Classifications*	Category A
Marine Approvals	LRS: 01/00171 (E1), ABS: 16-LD1472056-PDA
GOST R Certificate	POCC GB.AF35.H00102
Ingress Protection Rating**	IP66 as standard (IP67, IP68*** available upon request)
Cable Gland Material	Brass, Electroless Nickel Plated Brass, Stainless Steel, Aluminium
Seal Material	CMP Thermoset Rubber
Cable Type	Wire Braid Armour, Screened Flexible (EMC) Wire Braid (e.g. CY / SY), Pliable Wire Armour (PWA), Steel Tape Armour (STA)
Armour Clamping	Detachable Armour Cone & AnyWay Universal Clamping Ring
Sealing Technique	Unique CMP 'LRS' Outer Seal (Load Retention Seal)
Sealing Area(s)	Cable Outer Sheath
Cable Gland Kits Available	Cable Gland kit for use with all types of cable includes 2 Brass Cable Glands, 2 Steel Locknuts, 2 Brass Earth Tags and 2 PVC Shrouds for sizes up to and including 32mm. For sizes 40mm and above each kit includes 1 of each component.

* Mechanical & Electrical Classifications applied as per IEC 62444 & EN 62444

** When CMP installation accessories are used. Refer to page 7 or www.cmp-products.com for further information.

*** IP68 tested to a minimum depth of 30 metres for 12 hours, alternate depths / durations can be provided upon request

Cable Gland Selection Table

Refer to illustration at the top of the page.

Cable Gland Size	Available Entry Threads "C" (Alternate Metric Thread Lengths Available)		Cable Bedding Diameter "A"	Overall Cable Diameter "B"		Armour Range † Grooved Cone (X)		Across Flats "D"	Across Corners "D"	Protrusion Length "F"	Combined Ordering Reference (*Brass Metric)			Shroud	Cable Gland Weight (Kgs)
	Metric	Thread Length "E"		Min	Max	Min	Max				Size	Type	Ordering Suffix		
20S16	M20	10.0	8.7	6.1	13.1	0.3	1.0	24.0	26.4	48.0	20S16	CX	1RA	PVC04	0.100
	M20	10.0	11.7	9.5	15.9	0.3	1.0	24.0	26.4	48.0	20S	CX	1RA	PVC04	0.100
20	M20	10.0	14.0	12.5	20.9	0.4	1.0	30.5	33.6	48.0	20	CX	1RA	PVC06	0.147
25S	M25	10.0	20.0	14.0	22.0	0.4	1.2	37.5	41.3	56.0	25S	CX	1RA	PVC09	0.224
25	M25	10.0	20.0	18.2	26.2	0.4	1.2	37.5	41.3	56.0	25	CX	1RA	PVC09	0.221
32	M32	10.0	26.3	23.7	33.9	0.4	1.2	46.0	50.6	54.0	32	CX	1RA	PVC11	0.306
40	M40	15.0	32.2	27.9	40.4	0.4	1.6	55.0	60.5	58.0	40	CX	1RA	PVC15	0.448
50S	M50	15.0	38.2	35.2	46.7	0.4	1.6	60.0	66.0	61.0	50S	CX	1RA	PVC18	0.567
50	M50	15.0	44.1	40.4	53.0	0.6	1.6	70.1	77.1	60.0	50	CX	1RA	PVC21	0.751
63S	M63	15.0	50.0	45.6	59.4	0.6	1.6	75.0	82.5	74.0	63S	CX	1RA	PVC23	1.036
63	M63	15.0	56.0	54.6	65.8	0.6	1.6	80.0	88.0	71.0	63	CX	1RA	PVC25	1.016
75S	M75	15.0	62.0	59.0	72.0	0.6	1.6	90.0	99.0	86.0	75S	CX	1RA	PVC28	1.787
75	M75	15.0	68.0	66.7	78.4	0.6	1.6	100.0	110.0	82.0	75	CX	1RA	PVC30	2.091
90	M90	24.0	80.0	76.2	90.3	0.8	1.6	114.3	125.7	95.0	90	CX	1RA	PVC32	3.044
100	M100	24.0	91.0	86.1	101.4	0.8	1.6	123.0	135.3	95.0	100	CX	1RA	LSF33	3.132
115	M115	24.0	98.0	101.5	110.2	0.8	1.6	133.4	146.7	107.5	115	CX	1RA	LSF34	4.476
130	M130	24.0	115.0	110.2	123.2	0.8	1.6	152.4	167.6	110.0	130	CX	1RA	LSF35	5.761

*For material options add the following suffix to the Ordering Reference; Brass (no suffix required); Nickel Plated Brass '5'; 316 Grade Stainless Steel '4'; Copper Free Aluminium '1'

Examples: 20CX1RA5 = Nickel Plated Brass M20

Dimensions are displayed in millimetres unless otherwise stated

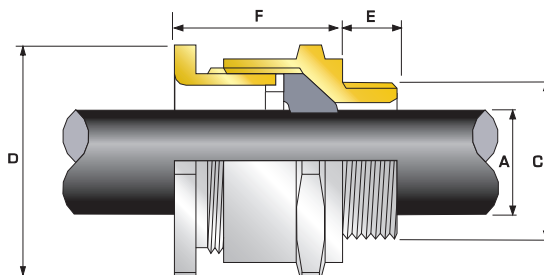
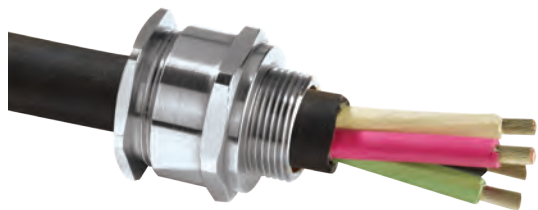

A2

A2 Single Seal Industrial Cable Gland

For all types of Unarmoured & Braided Cables

- High quality durable materials
- Robust, heavy duty design
- Displacement type seal
- Deluge protected
- -60°C to +130°C (standard), -20°C to 200°C (ThermIn option page 91)



TECHNICAL DATA	
Design Specification	BS 6121:Part 1:1989, IEC 62444, EN 62444
Mechanical Classifications*	Impact = Level 8, Cable Anchorage = Class B
Enclosure Protection	IK10 to IEC 62262 (20 joules) Brass & Stainless Steel only
CSA Certificate	1211841
Code of Protection	Enclosure Type 4X
Marine Approvals	LRS: 01/00171 (E1), ABS: 16-LD1472056-PDA
GOST R Certificate	POCC GB.AГ35.H00102
Ingress Protection Rating**	IP66, IP67 & IP68***
Deluge Protection Compliance	DT501 : 91
Cable Gland Material	Brass, Electroless Nickel Plated Brass, Stainless Steel, Aluminium
Seal Material	CMP Thermoset Rubber
Cable Type	Unarmoured & Braided when terminated inside enclosure
Sealing Technique	CMP Unique Displacement Seal Concept
Sealing Area(s)	Cable Outer Sheath

* Mechanical & Electrical Classifications applied as per IEC 62444 & EN 62444
 ** When CMP installation accessories are used. Refer to page 7 or www.cmp-products.com for further information.
 *** IP68 tested to a minimum depth of 30 metres for 12 hours, alternate depths / durations can be provided upon request

Cable Gland Selection Table

Refer to illustration at the top of the page.

Cable Gland Size	Available Entry Threads "C" (Alternate Thread Lengths Available)		Overall Cable Diameter "A"		Across Flats "D"	Across Corners "D"	Protrusion Length "F"	Combined Ordering Reference (*Brass Metric)			Shroud	Cable Gland Weight (Kgs)
	Standard		Min	Max	Max	Max		Size	Type	Ordering Suffix		
	Metric	Thread Length "E"										
20S16	M20	10.0	3.2	8.7	24.0	26.4	25.1	20S16	A2	1RA	PVC04	0.070
20S	M20	10.0	6.1	11.7	24.0	26.4	25.1	20S	A2	1RA	PVC04	0.060
20	M20	10.0	6.5	14.0	27.0	29.7	27.2	20	A2	1RA	PVC05	0.070
25	M25	10.0	11.1	20.0	36.0	39.6	35.5	25	A2	1RA	PVC09	0.130
32	M32	10.0	17.0	26.3	41.0	45.1	34.2	32	A2	1RA	PVC10	0.150
40	M40	15.0	23.5	32.2	50.0	55.0	35.1	40	A2	1RA	PVC13	0.200
50S	M50	15.0	31.0	38.2	55.0	60.5	32.0	50S	A2	1RA	PVC15	0.260
50	M50	15.0	35.6	44.0	60.0	66.0	36.3	50	A2	1RA	PVC18	0.270
63S	M63	15.0	41.5	49.9	70.5	77.6	33.5	63S	A2	1RA	PVC21	0.430
63	M63	15.0	47.2	55.9	75.0	82.5	35.8	63	A2	1RA	PVC23	0.460
75S	M75	15.0	54.0	61.9	84.0	92.4	34.2	75S	A2	1RA	PVC26	0.520
75	M75	15.0	61.1	67.9	84.0	92.4	40.6	75	A2	1RA	PVC26	0.500
90	M90	24.0	66.6	79.9	108.0	118.8	58.3	90	A2	1RA	PVC31	1.600
100	M100	24.0	76.0	91.0	123.0	135.3	55.2	100	A2	1RA	LSF33	1.780
115	M115	24.0	86.0	97.9	133.4	146.7	65.2	115	A2	1RA	LSF34	2.670
130	M130	24.0	97.0	114.9	152.4	167.6	73.9	130	A2	1RA	LSF35	3.800

*For material options add the following suffix to the Ordering Reference; Brass (no suffix required); Nickel Plated Brass '5'; 316 Grade Stainless Steel '4'; Copper Free Aluminium '1'

Examples: 20A21RA5 = Nickel Plated Brass M20

Dimensions are displayed in millimetres unless otherwise stated

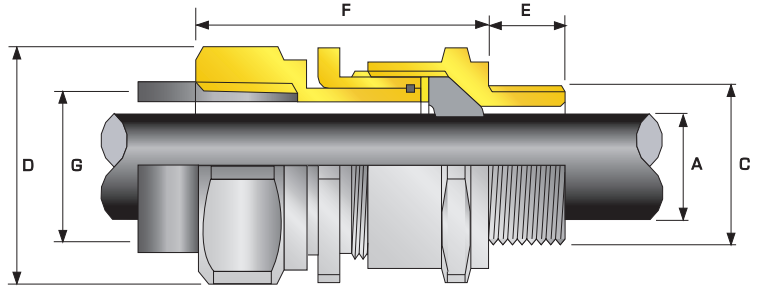

A2RC

A2RC Industrial Cable Gland with Conduit Connection Facility

For all types of Unarmoured Cables

- Designed for rigid & flexible conduits
- Easy install running coupler design
- Displacement type seal
- -60°C to +130°C



Alternative conduit sizes available upon request.

See 'thread option ordering examples' table below for typical NPT & Metric thread ordering references

THREAD OPTION ORDERING EXAMPLES

Ordering Reference	Male Thread	Female Thread
20A2RC1RA	M20	M20
20A2RC1RA031	M20	½" NPT
20A2RC1RA03131	½" NPT	½" NPT
20A2RC1RA03102†	½" NPT	M20

Refer to 'How to order' page for complete list of ordering codes.
 † For Metric female threads please insert '0' before thread size code
 e.g. 32A2RC1RA53405 (1 ¼" NPT Male x M40 Female)

TECHNICAL DATA

Design Specification	BS 6121:Part 1:1989, IEC 62444, EN 62444
Mechanical Classifications*	Impact = Level 8, Cable Anchorage = Class D
Enclosure Protection	IK10 to IEC 62262 (20 joules) Brass & Stainless Steel only
GOST R Certificate	POCC GB.AГ35.H00102
Ingress Protection Rating**	IP66
Cable Gland Material	Brass, Electroless Nickel Plated Brass, Stainless Steel, Aluminium
Seal Material	CMP Thermoset Rubber
Cable Type	Unarmoured
Sealing Technique	CMP Unique Displacement Seal Concept
Sealing Area(s)	Cable Outer Sheath

* Mechanical & Electrical Classifications applied as per IEC 62444 & EN 62444

** When CMP installation accessories are used. Refer to page 7 or www.cmp-products.com for further information.

Cable Gland Selection Table

Refer to illustration at the top of the page.

Dimensions listed below are for metric cable glands only
 Dimensions for alternative threads may vary, please see supplementary technical data sheet

Cable Gland Size	Available Entry Threads "C" (Alternate Metric Thread Lengths Available)					Overall Cable Diameter "A"		Across Flats "D"	Across Corners "D"	Female Conduit Connection "G"	Protrusion Length "F"	Combined Ordering Reference (*Brass Metric male & female)			Shroud	Cable Gland Weight (Kgs)
	Standard			Option		Min	Max	Max	Max			Size	Type	Ordering Suffix		
	Metric	Thread Length (Metric) "E"	NPT	Thread Length (NPT) "E"	NPT											
20S16	M20	10.0	½"	19.9	¾"	3.2	8.7	24.0	26.4	M20	43.6	20S16	A2RC	1RA	PVC04	0.100
20S	M20	10.0	½"	19.9	¾"	6.1	11.7	24.0	26.4	M20	43.6	20S	A2RC	1RA	PVC04	0.100
20	M20	10.0	½"	19.9	¾"	6.5	14.0	27.0	29.7	M20	42.4	20	A2RC	1RA	PVC05	0.100
25	M25	10.0	¾"	20.2	1"	11.1	20.0	36.0	39.6	M25	50.4	25	A2RC	1RA	PVC09	0.190
32	M32	10.0	1"	25.0	1 ¼"	17.0	26.3	41.0	45.1	M32	50.7	32	A2RC	1RA	PVC10	0.230
40	M40	15.0	1 ¼"	25.6	1 ½"	23.5	32.2	50.0	55.0	M40	51.4	40	A2RC	1RA	PVC13	0.330
50S	M50	15.0	1 ½"	26.1	2"	31.0	38.2	55.0	60.5	M50	55.2	50S	A2RC	1RA	PVC15	0.430
50	M50	15.0	2"	26.9	2 ½"	35.6	44.0	60.0	66.0	M50	62.0	50	A2RC	1RA	PVC18	0.440
63S	M63	15.0	2"	26.9	2 ½"	41.5	49.9	70.5	77.6	M63	58.4	63S	A2RC	1RA	PVC21	0.720
63	M63	15.0	2 ½"	39.9	3"	47.2	55.9	75.0	82.5	M63	61.5	63	A2RC	1RA	PVC23	0.640
75S	M75	15.0	2 ½"	39.9	3"	54.0	61.9	79.0	88.0	M75	63.2	75S	A2RC	1RA	PVC26	0.900
75	M75	15.0	3"	41.5	3 ½"	61.1	67.9	84.0	92.4	M75	68.6	75	A2RC	1RA	PVC26	0.800
90	M90	24.0	3 ½"	42.8	4"	66.6	79.9	108.0	118.8	M90	94.2	90	A2RC	1RA	PVC31	2.200

*For material options add the following suffix to the Ordering Reference; Brass (no suffix required); Nickel Plated Brass '5'; 316 Grade Stainless Steel '4'; Copper Free Aluminium '1'

For NPT male and / or female options please add the following digits to the material suffix (See Thread Options table above); ½" = 31, ¾" = 32, 1" = 33, 1 ¼" = 34, 1 ½" = 35, 2" = 36, 2 ½" = 37, 3" = 38, 3 ½" = 39, 4" = 310 (Brass requires prefix "0")

When NPT male & Metric female product option is required, please add the following digits to the material and NPT male suffix (See Thread Options table above); M20 = 01, M25 = 02, M32 = 03, M40 = 04, M50 = 05, M63 = 06, M75 = 07, M90 = 08 (Brass requires prefix "0")

Examples: 32A2RC1RA533 = Nickel Plated Brass M32 male x 1" NPT female, 20S16A2RC1RA031 = Brass M20 male x ½" NPT female, 25A2RC1RA43202 = Stainless Steel ¾" NPT male x M25 female, 220A2RC1RA5 = Nickel Plated Brass M20 M20 male & female

Dimensions are displayed in millimetres unless otherwise stated

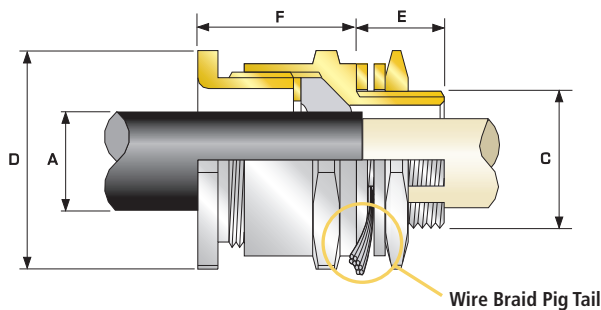

CXT

CXT Single Seal Industrial Cable Gland

For Screened Flexible (EMC) Braided Cables

- Easy install
- Mechanical retention of wire braid for electrical continuity
- Displacement type seal
- -60°C to +130°C
- Superior EMC performance

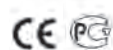

Supplied with Locknut & Washer

TECHNICAL DATA	
Design Specification	BS 6121:Part 1:1989, IEC 62444, EN 62444
Mechanical Classifications*	Impact = Level 8, Cable Anchorage = Class B
Enclosure Protection	IK10 to IEC 62262 (20 joules) Brass & Stainless Steel only
Electrical Classifications*	Category A
GOST R Certificate	POCC GB.AF35.H00102
Ingress Protection Rating**	IP66
Cable Gland Material	Brass, Electroless Nickel Plated Brass, Stainless Steel, Aluminium
Seal Material	CMP Thermoset Rubber
Cable Type	Screened Flexible (EMC) Wire Braid (e.g. CY / SY), Wire Braid Armour
Sealing Technique	CMP Unique Displacement Seal Concept
Sealing Area(s)	Cable Outer Sheath
Included Accessories	Locknut & Washer

* Mechanical & Electrical Classifications applied as per IEC 62444 & EN 62444
 ** When CMP installation accessories are used. Refer to page 7 or www.cmp-products.com for further information.

Cable Gland Selection Table

Refer to illustration at the top of the page.

Cable Gland Size	Entry Thread "C"	Thread Length (Metric) "E"	Overall Cable Diameter "A"		Across Flats "D"	Across Corners "D"	Protrusion Length "F"	Combined Ordering Reference (*Brass Metric)			Shroud	Cable Gland Weight (Kgs)
			Min	Max	Max	Max		Size	Type	Ordering Suffix		
20S16	M20	15.0	3.2	8.7	24.0	26.4	25.4	20S16	CXT	1RA	PVC04	0.070
20S	M20	15.0	6.1	11.7	24.0	26.4	25.4	20S	CXT	1RA	PVC04	0.060
20	M20	15.0	6.5	14.0	27.0	29.7	27.2	20	CXT	1RA	PVC05	0.070
25	M25	15.0	11.1	20.0	36.0	39.6	36.3	25	CXT	1RA	PVC09	0.130
32	M32	15.0	17.0	26.3	41.0	45.1	34.5	32	CXT	1RA	PVC10	0.150
40	M40	15.0	23.5	32.2	50.0	55.0	35.6	40	CXT	1RA	PVC13	0.210
50S	M50	15.0	31.0	38.2	55.0	60.5	32.3	50S	CXT	1RA	PVC15	0.260
50	M50	15.0	35.6	44.0	60.0	66.0	36.6	50	CXT	1RA	PVC18	0.270
63S	M63	15.0	41.5	49.9	70.5	77.6	33.5	63S	CXT	1RA	PVC21	0.410
63	M63	15.0	47.2	55.9	75.0	82.5	35.8	63	CXT	1RA	PVC23	0.400
75S	M75	15.0	54.0	61.9	80.0	88.0	36.8	75S	CXT	1RA	PVC25	0.530
75	M75	15.0	61.1	67.9	84.0	92.4	40.6	75	CXT	1RA	PVC26	0.500
90	M90	24.0	66.6	79.9	108.0	118.8	58.3	90	CXT	1RA	PVC31	1.600
100	M100	24.0	76.0	91.0	123.0	135.3	55.2	100	CXT	1RA	LSF33	1.780
115	M115	24.0	86.0	97.9	133.4	146.7	65.2	115	CXT	1RA	LSF34	2.670
130	M130	24.0	97.0	114.9	152.4	167.6	73.9	130	CXT	1RA	LSF35	3.800

*For material options add the following suffix to the Ordering Reference; Brass (no suffix required); Nickel Plated Brass 'S'; 316 Grade Stainless Steel '4'; Copper Free Aluminium '1'
 For NPT options add the following digits to the material suffix; 1/2" = 31; 3/4" = 32; 1" = 33; 1 1/4" = 34; 1 1/2" = 35; 2" = 36; 2 1/2" = 37; 3" = 38; 3 1/2" = 39; 4" = 310 (Brass requires prefix '0')

Examples: 32CXT1RA534 = Nickel Plated Brass 1 1/4" NPT, 50SCXT1RA035 = Brass 1 1/2" NPT, 25CXT1RA432 = Stainless Steel 3/4" NPT, 20CXT1RA5 = Nickel Plated Brass M20

Dimensions are displayed in millimetres unless otherwise stated

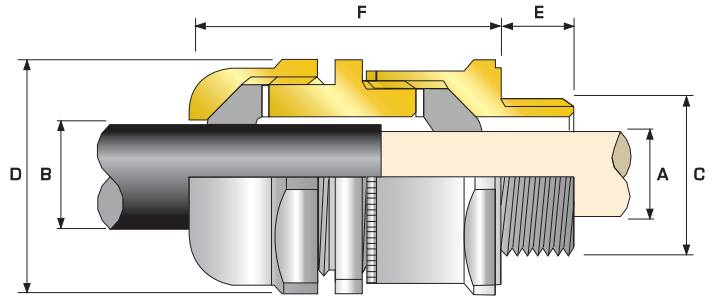

SS2KGP

SS2KGP Double Seal Industrial Cable Gland

For all types of Unarmoured & Braided Cables

- Direct & remote installation
- Superior levels of cable retention
- Displacement type seals
- Deluge protected
- -60°C to +130°C



TECHNICAL DATA

Design Specification	BS 6121:Part 1:1989, IEC 62444, EN 62444
Mechanical Classifications*	Impact = Level 8, Cable Anchorage = Class B
Enclosure Protection	IK10 to IEC 62262 (20 joules) Brass & Stainless Steel only
Marine Approvals	LRS: 01/00171 (E1), ABS: 16-LD1472056-PDA
GOST R Certificate	POCC GB.AF35.H00102
Ingress Protection Rating**	IP66, IP67 & IP68***
Cable Gland Material	Brass, Electroless Nickel Plated Brass, Stainless Steel, Aluminium
Seal Material	CMP Thermoset Rubber
Cable Type	Unarmoured
Sealing Technique	CMP Unique Displacement Seal Concept
Sealing Area(s)	Cable Inner Bedding & Outer Cable Sheath

* Mechanical & Electrical Classifications applied as per IEC 62444 & EN 62444

** When CMP installation accessories are used. Refer to page 7 or www.cmp-products.com for further information.

*** IP68 tested to a minimum depth of 30 metres for 12 hours, alternate depths / durations can be provided upon request

Cable Gland Selection Table

Refer to illustration at the top of the page.

Dimensions listed below are for metric cable glands only
Dimensions for alternative threads may vary, please see supplementary technical data sheet

Cable Gland Size	Available Entry Threads "C" (Alternate Metric Thread Lengths Available)					Overall Cable Diameter "A/B"		Across Flats "D"	Across Corners "D"	Protrusion Length "F"	Combined Ordering Reference (*Brass Metric)			Shroud	Cable Gland Weight (Kgs)
	Standard			Option		Min	Max	Max	Max		Size	Type	Ordering Suffix		
	Metric	Thread Length (Metric) "E"	NPT	Thread Length (NPT) "E"	NPT										
20S16	M20	10.0	½"	19.9	¾"	3.2	8.6	24.0	26.4	49.0	20S16	SS2KGP	1RA	PVC04	0.140
20S	M20	10.0	½"	19.9	¾"	6.1	11.7	24.0	26.4	49.0	20S	SS2KGP	1RA	PVC04	0.130
20	M20	10.0	½"	19.9	¾"	6.5	14.0	27.0	29.7	54.0	20	SS2KGP	1RA	PVC05	0.160
25	M25	10.0	¾"	20.2	1"	11.1	20.0	36.0	39.6	66.0	25	SS2KGP	1RA	PVC09	0.300
32	M32	10.0	1"	25.0	1 ¼"	17.0	26.3	41.0	45.1	67.0	32	SS2KGP	1RA	PVC10	0.350
40	M40	15.0	1 ¼"	25.6	1 ½"	23.5	32.1	50.0	55.0	70.0	40	SS2KGP	1RA	PVC13	0.500
50S	M50	15.0	1 ½"	26.1	2"	31.0	38.2	55.0	60.5	65.0	50S	SS2KGP	1RA	PVC15	0.560
50	M50	15.0	2"	26.9	2 ½"	35.6	44.0	60.0	66.0	70.0	50	SS2KGP	1RA	PVC18	0.590
63S	M63	15.0	2"	26.9	2 ½"	41.5	49.9	70.5	77.6	70.0	63S	SS2KGP	1RA	PVC21	0.890
63	M63	15.0	2 ½"	39.9	3"	47.2	55.9	75.0	82.5	71.0	63	SS2KGP	1RA	PVC23	0.850
75S	M75	15.0	2 ½"	39.9	3"	54.0	61.9	80.0	88.0	70.0	75S	SS2KGP	1RA	PVC25	1.020
75	M75	15.0	3"	41.5	3 ½"	61.1	67.9	84.0	92.4	75.0	75	SS2KGP	1RA	PVC26	0.990
90	M90	24.0	3 ½"	42.8	4"	66.6	79.4	108.0	118.8	113.0	90	SS2KGP	1RA	PVC31	2.990
100	M100	24.0	4"	44.0	5"	76.0	90.9	123.0	134.2	106.0	100	SS2KGP	1RA	LSF33	3.390
115	M115	24.0	4"	44.0	5"	86.0	97.9	133.4	146.7	128.0	115	SS2KGP	1RA	LSF34	5.320
130	M130	24.0	5"	46.8	-	97.0	114.9	152.4	167.6	129.0	130	SS2KGP	1RA	LSF35	6.350

*For material options add the following suffix to the Ordering Reference; Brass (no suffix required); Nickel Plated Brass '5'; 316 Grade Stainless Steel '4'; Copper Free Aluminium '1'
For NPT options add the following digits to the material suffix; ½" = 31; ¾" = 32; 1" = 33; 1 ¼" = 34; 1 ½" = 35; 2" = 36; 2 ½" = 37; 3" = 38; 3 ½" = 39; 4" = 310 (Brass requires prefix '0')

Examples: 32SS2KGP1RA534 = Nickel Plated Brass 1 ¼" NPT, 50SS2KGP1RA035 = Brass 1 ½" NPT, 25SS2KGP1RA432 = Stainless Steel ¾" NPT, 20SS2KGP1RA5 = Nickel Plated Brass M20

Dimensions are displayed in millimetres unless otherwise stated

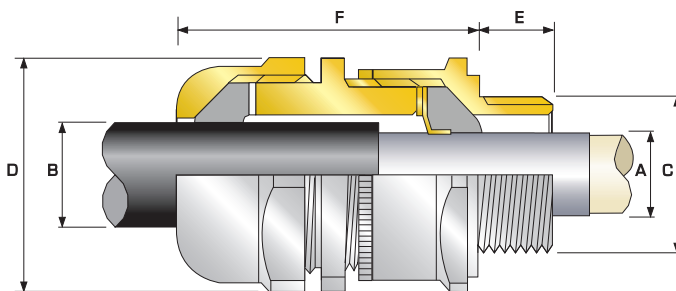

SS2KGPPB

SS2KGPPB Double Seal Industrial Cable Gland

For all types of Lead Sheathed Unarmoured Cables

- Effectively earths / grounds lead sheathed cables
- Suitable for Tape Armours
- Direct & remote installation
- Superior levels of cable retention
- Displacement type seals
- Deluge protected
- -60°C to +130°C



TECHNICAL DATA	
Design Specification	BS 6121:Part 1:1989, IEC 62444, EN 62444
Mechanical Classifications*	Impact = Level 8, Cable Anchorage = Class B
Enclosure Protection	IK10 to IEC 62262 (20 joules) Brass & Stainless Steel only
Marine Approvals	LRS: 01/00171 (E1), ABS: 16-LD1472056-PDA
GOST R Certificate	POCC GB.AF35.H00102
Ingress Protection Rating**	IP66, IP67 & IP68***
Cable Gland Material	Brass, Electroless Nickel Plated Brass, Stainless Steel, Aluminium
Seal Material	CMP Thermoset Rubber
Cable Type	Unarmoured Lead Sheathed, Steel Tape Armour (STA), Aluminium Tape Armour (ATA)
Sealing Technique	CMP Unique Displacement Seal Concept
Sealing Area(s)	Cable Inner Lead Sheath & Outer Sheath

* Mechanical & Electrical Classifications applied as per IEC 62444 & EN 62444

** When CMP installation accessories are used. Refer to page 7 or www.cmp-products.com for further information.

*** IP68 tested to a minimum depth of 30 metres for 12 hours, alternate depths / durations can be provided upon request

Cable Gland Selection Table

Refer to illustration at the top of the page.

Dimensions listed below are for metric cable glands only

Dimensions for alternative threads may vary, please see supplementary technical data sheet

Cable Gland Size	Available Entry Threads "C" (Alternate Metric Thread Lengths Available)					Lead Sheath Diameter "A"		Overall Cable Diameter "B"		Across Flats "D"	Across Corners "D"	Protrusion Length "F"	Combined Ordering Reference (*Brass Metric)			Shroud	Cable Gland Weight (Kgs)
	Standard		Option			Min	Max	Min	Max	Max	Max		Size	Type	Ordering Suffix		
	Metric	Thread Length (Metric) "E"	NPT	Thread Length (NPT) "E"	NPT												
20S16	M20	10.0	1/2"	19.9	3/4"	3.2	7.8	3.2	8.6	24.0	26.4	49.5	20S16	SS2KGPPB	1RA	PVC04	0.140
20S	M20	10.0	1/2"	19.9	3/4"	6.1	11.0	6.1	11.7	24.0	26.4	49.5	20S	SS2KGPPB	1RA	PVC04	0.130
20	M20	10.0	1/2"	19.9	3/4"	6.5	13.4	6.5	14.0	27.0	29.7	54.5	20	SS2KGPPB	1RA	PVC05	0.160
25	M25	10.0	3/4"	20.2	1"	11.1	19.3	11.1	20.0	36.0	39.6	66.5	25	SS2KGPPB	1RA	PVC09	0.300
32	M32	10.0	1"	25.0	1 1/4"	17.0	25.5	17.0	26.3	41.0	45.1	67.5	32	SS2KGPPB	1RA	PVC10	0.350
40	M40	15.0	1 1/4"	25.6	1 1/2"	23.5	31.2	23.5	32.1	50.0	55.0	70.5	40	SS2KGPPB	1RA	PVC13	0.510
50S	M50	15.0	1 1/2"	26.1	2"	31.0	37.2	31.0	38.2	55.0	60.5	65.5	50S	SS2KGPPB	1RA	PVC15	0.570
50	M50	15.0	2"	26.9	2 1/2"	35.6	42.6	35.6	44.0	60.0	66.0	70.5	50	SS2KGPPB	1RA	PVC18	0.600
63S	M63	15.0	2"	26.9	2 1/2"	41.5	48.5	41.5	49.9	70.5	77.6	70.5	63S	SS2KGPPB	1RA	PVC21	0.900
63	M63	15.0	2 1/2"	39.9	3"	47.2	54.2	47.2	55.9	75.0	82.5	71.5	63	SS2KGPPB	1RA	PVC23	0.860
75S	M75	15.0	2 1/2"	39.9	3"	54.0	60.2	54.0	61.9	80.0	88.0	70.5	75S	SS2KGPPB	1RA	PVC25	1.030
75	M75	15.0	3"	41.5	3 1/2"	61.1	65.2	61.1	67.9	84.0	92.4	75.5	75	SS2KGPPB	1RA	PVC26	1.000
90	M90	24.0	3 1/2"	42.8	4"	66.6	77.1	66.6	79.4	108.0	118.8	113.5	90	SS2KGPPB	1RA	PVC31	3.010
100	M100	24.0	3 1/2"	42.8	4"	76.0	88.1	76.0	90.9	123.0	134.2	106.5	100	SS2KGPPB	1RA	LSF33	3.410
115	M115	24.0	4"	44.0	5"	86.0	94.1	86.0	97.9	133.4	146.7	128.5	115	SS2KGPPB	1RA	LSF34	5.350
130	M130	24.0	5"	46.8	-	97.0	110.1	97.0	114.9	152.4	167.6	129.5	130	SS2KGPPB	1RA	LSF35	6.390

*For material options add the following suffix to the Ordering Reference; Brass (no suffix required); Nickel Plated Brass '5'; 316 Grade Stainless Steel '4'; Copper Free Aluminium '1'
For NPT options add the following digits to the material suffix; 1/2" = 31; 3/4" = 32; 1" = 33; 1 1/4" = 34; 1 1/2" = 35; 2" = 36; 2 1/2" = 37; 3" = 38; 3 1/2" = 39; 4" = 310 (Brass requires prefix '0')

Examples: 32SS2KGPPB1RA534 = Nickel Plated Brass 1 1/4" NPT, 50SS2KGPPB1RA035 = Brass 1 1/2" NPT, 25SS2KGPPB1RA432 = Stainless Steel 3/4" NPT, 20SS2KGPPB1RA5 = Nickel Plated Brass M20

Dimensions are displayed in millimetres unless otherwise stated

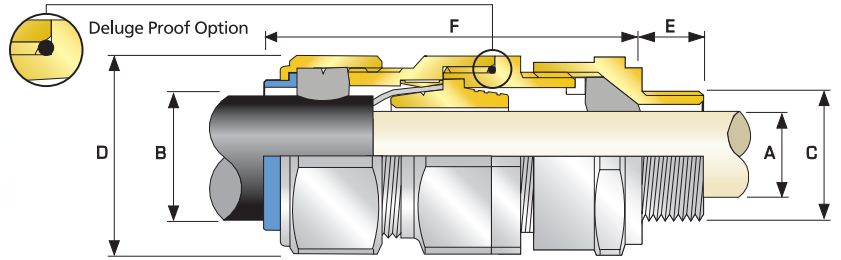

E1U

E1U Double Seal Industrial Cable Gland

For all types of Armoured Cables

- Metal-to-metal armour clamping
- Direct & remote installation
- Permanently crimped, low impedance earth termination
- Secure against self-loosening
- Displacement type inner seal
- Controlled outer 'load retention' seal
- Unique OSTG prevents overtightening
- Deluge protection option
- -60°C to +130°C (standard), -20°C to 200°C (Thermin option page 91)
- Superior EMC performance



† Grooved Cone (X) is predominantly used for Wire Braid (e.g. GSWB, TCWB), Steel Tape Armour (STA, DSTA) and Aluminium Strip Armour (ASA) but is also suitable for Single Wire Armour (SWA), Aluminium Wire Armour (AWA) and Pliable Wire Armour (PWA) if the range is outside that of the Stepped Cone (W).

Grooved Cone (X) dimensions shown in the Cable Gland Selection Table below are for a double wire strand of braid armour cables. Tapes can also be doubled over. For cables that have only a single layer of armour such as SWA the clamping range should be used as shown in the table below.

Stepped (W) Cone is suitable for Single Wire Armour (SWA), or Aluminium Wire Armour (AWA) cables.

TECHNICAL DATA

Design Specification	BS 6121:Part 1:1989, IEC 62444, EN 62444
Mechanical Classifications*	Impact = Level 8, Cable Anchorage = Class D
Enclosure Protection	IK10 to IEC 62262 (20 joules) Brass & Stainless Steel only
Electrical Classifications*	Category B (Category A when used with braid, tape or pliable wire armour cables)
Marine Approvals	LRS: 01/00171 (E1), ABS: 16-LD1472056-PDA
GOST R Certificate	POCC GB.AF35.H00102
Ingress Protection Rating**	IP66 as standard (IP67, IP68*** available upon request)
Cable Gland Material	Brass, Electroless Nickel Plated Brass, Aluminium
Seal Material	CMP Thermoset Rubber
Cable Type	Single Wire Armour (SWA), Aluminium Wire Armour (AWA), Pliable Wire Armour (PWA), Steel Tape Armour (STA), Wire Braid Armour, Aluminium Strip Armour (ASA), Screened Flexible (EMC) Wire Braid (e.g. CY / SY), Armoured & Jacketed
Armour Clamping	Reversible Armour Cone & AnyWay Universal Clamping Ring
Sealing Technique	CMP Inner Displacement Seal & Unique CMP 'LRS'™ Outer Load Retention Seal
Sealing Area(s)	Cable Inner Bedding & Outer Cable Sheath

* Mechanical & Electrical Classifications applied as per IEC 62444 & EN 62444

** When CMP installation accessories are used. Refer to page 7 or www.cmp-products.com for further information.

*** IP68 tested to a minimum depth of 30 metres for 12 hours, alternate depths / durations can be provided upon request

Cable Gland Selection Table

Refer to illustration at the top of the page.

Dimensions listed below are for metric cable glands only

Dimensions for alternative threads may vary, please see supplementary technical data sheet

Cable Gland Size	Available Entry Threads "C" (Alternate Metric Thread Lengths Available)				Cable Bedding Diameter "A"		Overall Cable Diameter "B"		Armour Range †				Across Flats "D"	Across Corners "D"	Protrusion Length "F"	Combined Ordering Reference (*Brass Metric)			Shroud	Cable Gland Weight (Kgs)	
	Standard		Option		Min	Max	Min	Max	Grooved Cone (X)		Stepped Cone (W)					Size	Type	Ordering Suffix			
	Metric	Thread Length (Metric) "E"	NPT	Thread Length (NPT) "E"					NPT	Min	Max	Min	Max	Min	Max				Min	Max	
20S16	M20	10.0	½"	19.9	¾"	3.1	8.6	6.1	13.1	0.3	1.0	0.8	1.25	24.0	26.4	72.5	20S16	E1U	1RA	PVC04	0.163
20S	M20	10.0	½"	19.9	¾"	6.1	11.6	9.5	15.9	0.3	1.0	0.8	1.25	24.0	26.4	70.0	20S	E1U	1RA	PVC04	0.150
20	M20	10.0	½"	19.9	¾"	6.5	13.9	12.5	20.9	0.4	1.0	0.8	1.25	30.5	33.6	73.0	20	E1U	1RA	PVC06	0.210
25S	M25	10.0	¾"	20.2	1"	11.1	19.9	14.0	22.0	0.4	1.2	1.25	1.6	37.5	41.3	89.0	25S	E1U	1RA	PVC09	0.330
25	M25	10.0	¾"	20.2	1"	11.1	19.9	18.2	26.2	0.4	1.2	1.25	1.6	37.5	41.3	89.0	25	E1U	1RA	PVC09	0.330
32	M32	10.0	1"	25.0	1 ¼"	17.0	26.2	23.7	33.9	0.4	1.2	1.6	2.0	46.0	50.6	86.0	32	E1U	1RA	PVC11	0.430
40	M40	15.0	1 ¼"	25.6	1 ½"	22.0	32.1	27.9	40.4	0.4	1.6	1.6	2.0	55.0	60.5	90.0	40	E1U	1RA	PVC15	0.620
50S	M50	15.0	1 ½"	26.1	2"	29.5	38.1	35.2	46.7	0.4	1.6	2.0	2.5	60.0	66.0	91.0	50S	E1U	1RA	PVC18	0.750
50	M50	15.0	2"	26.9	2 ½"	35.6	44.0	40.4	53.0	0.6	1.6	2.0	2.5	70.1	77.1	95.0	50	E1U	1RA	PVC21	0.950
63S	M63	15.0	2"	26.9	2 ½"	40.1	49.9	45.6	59.4	0.6	1.6	2.0	2.5	75.0	82.5	102.0	63S	E1U	1RA	PVC23	1.340
63	M63	15.0	2 ½"	39.9	3"	47.2	55.9	54.6	65.8	0.6	1.6	2.0	2.5	80.0	88.0	104.0	63	E1U	1RA	PVC25	1.340
75S	M75	15.0	2 ½"	39.9	3"	52.8	61.9	59.0	72.0	0.6	1.6	2.0	2.5	90.0	99.0	115.0	75S	E1U	1RA	PVC28	2.110
75	M75	15.0	3"	41.5	3 ½"	59.1	67.9	66.7	78.4	0.6	1.6	2.5	3.0	100.0	110.0	117.0	75	E1U	1RA	PVC30	2.420
90	M90	24.0	3 ½"	42.8	4"	66.6	78.6	76.2	90.3	0.8	1.6	3.15	4.0	114.3	125.4	147.0	90	E1U	1RA	PVC32	4.210
100	M100	24.0	4"	44.0	5"	76.0	90.9	86.1	101.4	0.8	1.6	3.15	4.0	123.0	135.3	140.0	100	E1U	1RA	LSF33	4.450
115	M115	24.0	4"	44.0	5"	86.0	97.9	101.5	110.2	0.8	1.6	3.15	4.0	133.4	146.7	162.0	115	E1U	1RA	LSF34	6.190
130	M130	24.0	5"	46.8	6"	97.0	114.9	110.2	123.2	0.8	1.6	3.15	4.0	152.4	167.6	174.0	130	E1U	1RA	LSF35	8.340

*Note : For material options please add the following suffix to change the Ordering Reference ; Brass (no suffix required), Nickel Plated Brass "S", Copper Free Aluminium "1" For NPT options add the following digits to the material suffix; ½" = 31; ¾" = 32; 1" = 33; 1 ¼" = 34; 1 ½" = 35; 2" = 36; 2 ½" = 37; 3" = 38; 3 ½" = 39; 4" = 310 (Brass requires prefix '0')

Examples: 32E1U1RA534 = Nickel Plated Brass 1 ¼" NPT, 50SE1U1RA035 = Brass 1 ½" NPT, 20E1U1RA5 = Nickel Plated Brass M20

Dimensions are displayed in millimetres unless otherwise stated

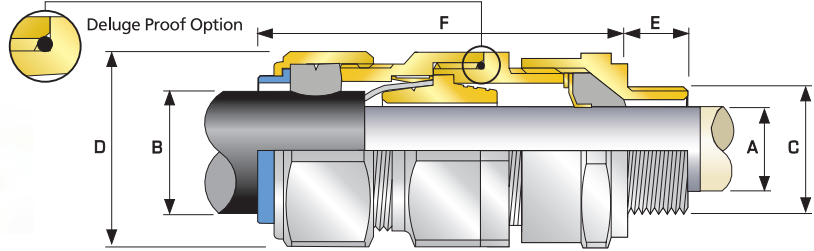

E2U

E2U Double Seal Industrial Cable Gland

For all types of Lead Sheathed Armoured Cables

- Effectively earths / grounds lead sheathed cables
- Metal-to-metal armour clamping
- Direct & remote installation
- Permanently crimped, low impedance earth termination
- Secure against self-loosening
- Displacement type inner seal
- Controlled outer 'load retention' seal
- Unique OSTG prevents overtightening
- Deluge protection option
- -60°C to +130°C
- Superior EMC performance



† Grooved Cone (X) is predominantly used for Wire Braid (e.g. GSWB, TCWB), Steel Tape Armour (STA, DSTA) and Aluminium Strip Armour (ASA) but is also suitable for Single Wire Armour (SWA), Aluminium Wire Armour (AWA) and Pliable Wire Armour (PWA) if the range is outside that of the Stepped Cone (W).

Grooved Cone (X) dimensions shown in the Cable Gland Selection Table below are for a double wire strand of braid armour cables. Tapes can also be doubled over. For cables that have only a single layer of armour such as SWA the clamping range should be used as shown in the table below.

Stepped (W) Cone is suitable for Single Wire Armour (SWA), or Aluminium Wire Armour (AWA) cables.

TECHNICAL DATA	
Design Specification	BS 6121:Part 1:1989, IEC 62444, EN 62444
Mechanical Classifications*	Impact = Level 8, Cable Anchorage = Class D
Enclosure Protection	IK10 to IEC 62262 (20 joules) Brass & Stainless Steel only
Electrical Classifications*	Category B (Category A when used with braid, tape or pliable wire armour cables)
Marine Approvals	LRS: 01/00171 (E1), ABS: 16-LD1472056-PDA
GOST R Certificate	POCC GB.AF35.H00102
Ingress Protection Rating**	IP66 as standard (IP67, IP68*** available upon request)
Cable Gland Material	Brass, Electroless Nickel Plated Brass, Aluminium
Seal Material	CMP Thermoset Rubber
Cable Type	Lead Sheathed & Single Wire Armour (LC/SWA), Lead Sheathed & Wire Braid Armour, Lead Sheathed & Steel Tape Armour (LC/STA), Lead Sheathed & Pliable Wire Armour (LC/PWA), Lead Sheathed & Strip Armour (LC/ASA)
Armour Clamping	Reversible Armour Cone & AnyWay Universal Clamping Ring
Sealing Technique	CMP Inner Displacement Seal & Unique CMP 'LRS'™ Outer Load Retention Seal
Sealing Area(s)	Cable Inner Lead Sheath & Outer Sheath

* Mechanical & Electrical Classifications applied as per IEC 62444 & EN 62444

** When CMP installation accessories are used. Refer to page 7 or www.cmp-products.com for further information.

*** IP68 tested to a minimum depth of 30 metres for 12 hours, alternate depths / durations can be provided upon request

Cable Gland Selection Table

Refer to illustration at the top of the page.

Dimensions listed below are for metric cable glands only
Dimensions for alternative threads may vary, please see supplementary technical data sheet

Cable Gland Size	Available Entry Threads "C" (Alternate Metric Thread Lengths Available)					Cable Lead Sheath Diameter "A"		Overall Cable Diameter "B"		Armour Range †				Across Flats "D"	Across Corners "D"	Protrusion Length "F"	Combined Ordering Reference (*Brass Metric)			Shroud	Cable Gland Weight (Kgs)
	Standard			Option		Min	Max	Min	Max	Grooved Cone (X)		Stepped Cone (W)					Size	Type	Ordering Suffix		
	Metric	Thread Length (Metric) "E"	NPT	Thread Length (NPT) "E"	NPT					Min	Max	Min	Max	Min	Max	Min				Max	
20S16	M20	10.0	½"	19.9	¾"	3.1	7.8	6.1	13.1	0.3	1.0	0.8	1.25	24.0	26.4	72.5	20S16	E2U	1RA	PVC04	0.160
20S	M20	10.0	½"	19.9	¾"	6.1	11.0	9.5	15.9	0.3	1.0	0.8	1.25	24.0	26.4	70.0	20S	E2U	1RA	PVC04	0.150
20	M20	10.0	½"	19.9	¾"	6.5	13.4	12.5	20.9	0.4	1.0	0.8	1.25	30.5	33.6	73.0	20	E2U	1RA	PVC06	0.210
25S	M25	10.0	¾"	20.2	1"	11.1	19.3	14.0	22.0	0.4	1.2	1.25	1.6	37.5	41.3	89.0	25S	E2U	1RA	PVC09	0.330
25	M25	10.0	¾"	20.2	1"	11.1	19.3	18.2	26.2	0.4	1.2	1.25	1.6	37.5	41.3	89.0	25	E2U	1RA	PVC09	0.330
32	M32	10.0	1"	25.0	1 ¼"	17.0	25.5	23.7	33.9	0.4	1.2	1.6	2.0	46.0	50.6	86.0	32	E2U	1RA	PVC11	0.430
40	M40	15.0	1 ¼"	25.6	1 ½"	22.0	31.2	27.9	40.4	0.4	1.6	1.6	2.0	55.0	60.5	90.0	40	E2U	1RA	PVC15	0.620
50S	M50	15.0	1 ½"	26.1	2"	29.5	37.2	35.2	46.7	0.4	1.6	2.0	2.5	60.0	66.0	91.0	50S	E2U	1RA	PVC18	0.750
50	M50	15.0	2"	26.9	2 ½"	35.6	42.6	40.4	53.0	0.6	1.6	2.0	2.5	70.1	77.1	95.0	50	E2U	1RA	PVC21	0.960
63S	M63	15.0	2"	26.9	2 ½"	40.1	48.5	45.6	59.4	0.6	1.6	2.0	2.5	75.0	82.5	102.0	63S	E2U	1RA	PVC23	1.350
63	M63	15.0	2 ½"	39.9	3"	47.2	54.2	54.6	65.8	0.6	1.6	2.0	2.5	80.0	88.0	104.0	63	E2U	1RA	PVC25	1.350
75S	M75	15.0	2 ½"	39.9	3"	52.8	60.2	59.0	72.0	0.6	1.6	2.0	2.5	90.0	99.0	115.0	75S	E2U	1RA	PVC28	2.120
75	M75	15.0	3"	41.5	3 ½"	59.1	65.2	66.7	78.4	0.6	1.6	2.5	3.0	100.0	110.0	117.0	75	E2U	1RA	PVC30	2.430
90	M90	24.0	3 ½"	42.8	4"	66.6	77.1	76.2	90.3	0.8	1.6	3.15	4.0	114.3	125.4	147.0	90	E2U	1RA	PVC32	4.230
100	M100	24.0	4"	44.0	5"	76.0	88.1	86.1	101.4	0.8	1.6	3.15	4.0	123.0	135.3	140.0	100	E2U	1RA	LSF33	4.470
115	M115	24.0	4"	44.0	5"	86.0	94.1	101.5	110.2	0.8	1.6	3.15	4.0	133.4	146.7	162.0	115	E2U	1RA	LSF34	6.210
130	M130	24.0	5"	46.8	6"	97.0	110.1	110.2	123.2	0.8	1.6	3.15	4.0	152.4	167.6	174.0	130	E2U	1RA	LSF35	8.360

*Note : For material options please add the following suffix to change the Ordering Reference : Brass (no suffix required), Nickel Plated Brass "5", Copper Free Aluminium "1" For NPT options add the following digits to the material suffix; ½" = 31; ¾" = 32; 1" = 33; 1 ¼" = 34; 1 ½" = 35; 2" = 36; 2 ½" = 37; 3" = 38; 3 ½" = 39; 4" = 310 (Brass requires prefix '0')

Examples: 32E2U1RA534 = Nickel Plated Brass 1 ¼" NPT, 50SE2U1RA035 = Brass 1 ½" NPT, 20E2U1RA5 = Nickel Plated Brass M20

Dimensions are displayed in millimetres unless otherwise stated

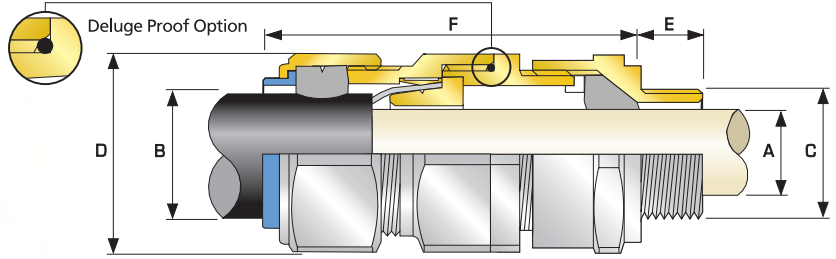

E1W

E1W Double Seal Industrial Cable Gland

For all types of Steel & Aluminium Wire Armoured Cables

- Metal-to-metal armour clamping
- Direct & remote installation
- Permanently crimped, low impedance earth termination
- Secure against self-loosening
- Displacement type inner seal
- Controlled outer 'load retention' seal
- Unique OSTG prevents overtightening
- Deluge protection option
- -60°C to +130°C
- Superior EMC performance



TECHNICAL DATA

Design Specification	BS 6121:Part 1:1989, IEC 62444, EN 62444
Mechanical Classifications*	Impact = Level 8, Cable Anchorage = Class D
Enclosure Protection	IK10 to IEC 62262 (20 joules) Brass & Stainless Steel only
Electrical Classifications*	Category B
Marine Approvals	LRS: 01/00171 (E1), ABS: 16-LD1472056-PDA
GOST R Certificate	POCC GB.AF35.H00102
Ingress Protection Rating**	IP66 as standard (IP67, IP68*** available upon request)
Cable Gland Material	Brass, Electroless Nickel Plated Brass, Aluminium
Seal Material	CMP Thermoset Rubber
Cable Type	Single Wire Armour (SWA), Aluminium Wire Armour (AWA)
Armour Clamping	Detachable Armour Cone & AnyWay Universal Clamping Ring
Sealing Technique	CMP Inner Displacement Seal & Unique CMP 'LRS'™ Outer Load Retention Seal
Sealing Area(s)	Cable Inner Bedding & Outer Cable Sheath

* Mechanical & Electrical Classifications applied as per IEC 62444 & EN 62444
 ** When CMP installation accessories are used. Refer to page 7 or www.cmp-products.com for further information.
 *** IP68 tested to a minimum depth of 30 metres for 12 hours, alternate depths / durations can be provided upon request

Cable Gland Selection Table

Refer to illustration at the top of the page.

Dimensions listed below are for metric cable glands only
 Dimensions for alternative threads may vary, please see supplementary technical data sheet

Cable Gland Size	Available Entry Threads "C" (Alternate Metric Thread Lengths Available)					Cable Bedding Diameter "A"		Overall Cable Diameter "B"		Armour Range		Across Flats "D"	Across Corners "D"	Protrusion Length "F"	Combined Ordering Reference (*Brass Metric)			Shroud	Cable Gland Weight (Kgs)
	Standard			Option		Min	Max	Min	Max	Min	Max	Max	Max		Size	Type	Ordering Suffix		
	Metric	Thread Length (Metric) "E"	NPT	Thread Length (NPT) "E"	NPT														
20S16	M20	10.0	1/2"	19.9	3/4"	3.1	8.6	6.1	13.1	0.8	1.25	24.0	26.4	72.5	20S16	E1W	1RA	PVC04	0.163
20S	M20	10.0	1/2"	19.9	3/4"	6.1	11.6	9.5	15.9	0.8	1.25	24.0	26.4	70.0	20S	E1W	1RA	PVC04	0.150
20	M20	10.0	1/2"	19.9	3/4"	6.5	13.9	12.5	20.9	0.8	1.25	30.5	33.6	73.0	20	E1W	1RA	PVC06	0.210
25S	M25	10.0	3/4"	20.2	1"	11.1	19.9	14.0	22.0	1.25	1.6	37.5	41.3	89.0	25S	E1W	1RA	PVC09	0.330
25	M25	10.0	3/4"	20.2	1"	11.1	19.9	18.2	26.2	1.25	1.6	37.5	41.3	89.0	25	E1W	1RA	PVC09	0.330
32	M32	10.0	1"	25.0	1 1/4"	17.0	26.2	23.7	33.9	1.6	2.0	46.0	50.6	86.0	32	E1W	1RA	PVC11	0.430
40	M40	15.0	1 1/4"	25.6	1 1/2"	22.0	32.1	27.9	40.4	1.6	2.0	55.0	60.5	90.0	40	E1W	1RA	PVC15	0.620
50S	M50	15.0	1 1/2"	26.1	2"	29.5	38.1	35.2	46.7	2.0	2.5	60.0	66.0	91.0	50S	E1W	1RA	PVC18	0.750
50	M50	15.0	2"	26.9	2 1/2"	35.6	44.0	40.4	53.0	2.0	2.5	70.1	77.1	95.0	50	E1W	1RA	PVC21	0.950
63S	M63	15.0	2"	26.9	2 1/2"	40.1	49.9	45.6	59.4	2.0	2.5	75.0	82.5	102.0	63S	E1W	1RA	PVC23	1.340
63	M63	15.0	2 1/2"	39.9	3"	47.2	55.9	54.6	65.8	2.0	2.5	80.0	88.0	104.0	63	E1W	1RA	PVC25	1.340
75S	M75	15.0	2 1/2"	39.9	3"	52.8	61.9	59.0	72.0	2.0	2.5	90.0	99.0	115.0	75S	E1W	1RA	PVC28	2.110
75	M75	15.0	3"	41.5	3 1/2"	59.1	67.9	66.7	78.4	2.5	3.0	100.0	110.0	117.0	75	E1W	1RA	PVC30	2.420
90	M90	24.0	3 1/2"	42.8	4"	66.6	78.6	76.2	90.3	3.15	4.0	114.3	125.4	147.0	90	E1W	1RA	PVC32	4.210
100	M100	24.0	4"	44.0	5"	76.0	90.9	86.1	101.4	3.15	4.0	123.0	135.3	140.0	100	E1W	1RA	LSF33	4.450
115	M115	24.0	4"	44.0	5"	86.0	97.9	101.5	110.2	3.15	4.0	133.4	146.7	162.0	115	E1W	1RA	LSF34	6.190
130	M130	24.0	5"	46.8	6"	97.0	114.9	110.2	123.2	3.15	4.0	152.4	167.6	174.0	130	E1W	1RA	LSF35	8.340

*Note : For material options please add the following suffix to change the Ordering Reference ; Brass (no suffix required), Nickel Plated Brass "5", Copper Free Aluminium "1"
 For NPT options please add the following digits to the material suffix ; 1/2" = 31, 3/4" = 32, 1" = 33, 1 1/4" = 34, 1 1/2" = 35, 2" = 36, 2 1/2" = 37, 3" = 38, 3 1/2" = 39, 4" = 310 (Brass requires prefix "0")

Examples: 32E1W1RA534 = Nickel Plated Brass 1 1/4" NPT, 50SE1W1RA035 = Brass 1 1/2" NPT, 20E1W1RA5 = Nickel Plated Brass M20

Dimensions are displayed in millimetres unless otherwise stated

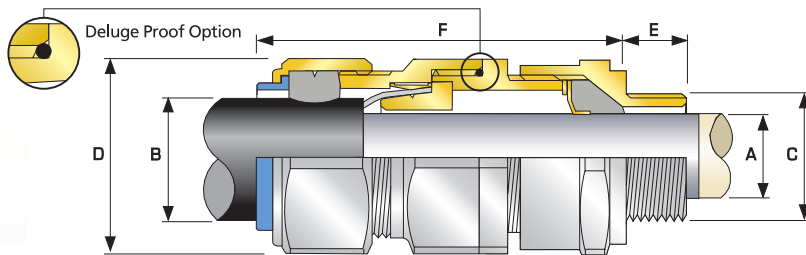

E2W

E2W Double Seal Industrial Cable Gland

For Lead Sheathed Steel & Aluminium Wire Armoured Cables

- Effectively earths / grounds lead sheathed cables
- Metal-to-metal armour clamping
- Direct & remote installation
- Permanently crimped, low impedance earth termination
- Secure against self-loosening
- Displacement type inner seal
- Controlled outer 'load retention' seal
- Unique OSTG prevents overtightening
- Deluge protection option
- -60°C to +130°C
- Superior EMC performance



TECHNICAL DATA	
Design Specification	BS 6121:Part 1:1989, IEC 62444, EN 62444
Mechanical Classifications*	Impact = Level 8, Cable Anchorage = Class D
Enclosure Protection	IK10 to IEC 62262 (20 joules) Brass & Stainless Steel only
Electrical Classifications*	Category B
Marine Approvals	LRS: 01/00171 (E1), ABS: 16-LD1472056-PDA
GOST R Certificate	POCC GB.AF35.H00102
Ingress Protection Rating**	IP66 as standard (IP67, IP68*** available upon request)
Cable Gland Material	Brass, Electroless Nickel Plated Brass, Aluminium,
Seal Material	CMP Thermoset Rubber
Cable Type	Lead Sheathed & Single Wire Armour (LC/SWA), Lead Sheathed & Aluminium Wire Armour (LC/AWA)
Armour Clamping	Detachable Armour Cone & AnyWay Universal Clamping Ring
Sealing Technique	CMP Inner Displacement Seal & Unique CMP 'LRS'™ Outer Load Retention Seal
Sealing Area(s)	Cable Inner Bedding & Outer Cable Sheath

* Mechanical & Electrical Classifications applied as per IEC 62444 & EN 62444
 ** When CMP installation accessories are used. Refer to page 7 or www.cmp-products.com for further information.
 *** IP68 tested to a minimum depth of 30 metres for 12 hours, alternate depths / durations can be provided upon request

Cable Gland Selection Table

Refer to illustration at the top of the page.

Dimensions listed below are for metric cable glands only

Dimensions for alternative threads may vary, please see supplementary technical data sheet

Cable Gland Size	Available Entry Threads "C" (Alternate Metric Thread Lengths Available)					Cable Lead Sheath Diameter "A"		Overall Cable Diameter "B"		Armour Range		Across Flats "D"	Across Corners "D"	Protrusion Length "F"	Combined Ordering Reference (*Brass Metric)			Shroud	Cable Gland Weight (Kgs)
	Standard			Option		Min	Max	Min	Max	Min	Max	Max	Max		Size	Type	Ordering Suffix		
	Metric	Thread Length (Metric) "E"	NPT	Thread Length (NPT) "E"	NPT														
20S16	M20	10.0	1/2"	19.9	3/4"	3.1	7.8	6.1	13.1	0.8	1.25	24.0	26.4	72.5	20S16	E2W	1RA	PVC04	0.160
20S	M20	10.0	1/2"	19.9	3/4"	6.1	11.0	9.5	15.9	0.8	1.25	24.0	26.4	70.0	20S	E2W	1RA	PVC04	0.150
20	M20	10.0	1/2"	19.9	3/4"	6.5	13.4	12.5	20.9	0.8	1.25	30.5	33.6	73.0	20	E2W	1RA	PVC06	0.210
25S	M25	10.0	3/4"	20.2	1"	11.1	19.3	14.0	22.0	1.25	1.6	37.5	41.3	89.0	25S	E2W	1RA	PVC09	0.330
25	M25	10.0	3/4"	20.2	1"	11.1	19.3	18.2	26.2	1.25	1.6	37.5	41.3	89.0	25	E2W	1RA	PVC09	0.330
32	M32	10.0	1"	25.0	1 1/4"	17.0	25.5	23.7	33.9	1.6	2.0	46.0	50.6	86.0	32	E2W	1RA	PVC11	0.430
40	M40	15.0	1 1/4"	25.6	1 1/2"	22.0	31.2	27.9	40.4	1.6	2.0	55.0	60.5	90.0	40	E2W	1RA	PVC15	0.620
50S	M50	15.0	1 1/2"	26.1	2"	29.5	37.2	35.2	46.7	2.0	2.5	60.0	66.0	91.0	50S	E2W	1RA	PVC18	0.750
50	M50	15.0	2"	26.9	2 1/2"	35.6	42.6	40.4	53.0	2.0	2.5	70.1	77.1	95.0	50	E2W	1RA	PVC21	0.950
63S	M63	15.0	2"	26.9	2 1/2"	40.1	48.5	45.6	59.4	2.0	2.5	75.0	82.5	102.0	63S	E2W	1RA	PVC23	1.340
63	M63	15.0	2 1/2"	39.9	3"	47.2	54.2	54.6	65.8	2.0	2.5	80.0	88.0	104.0	63	E2W	1RA	PVC25	1.340
75S	M75	15.0	2 1/2"	39.9	3"	52.8	60.2	59.0	72.0	2.0	2.5	90.0	99.0	115.0	75S	E2W	1RA	PVC28	2.110
75	M75	15.0	3"	41.5	3 1/2"	59.1	65.2	66.7	78.4	2.5	3.0	100.0	110.0	117.0	75	E2W	1RA	PVC30	2.420
90	M90	24.0	3 1/2"	42.8	4"	66.6	77.1	76.2	90.3	3.15	4.0	114.3	125.4	147.0	90	E2W	1RA	PVC32	4.210
100	M100	24.0	4"	44.0	5"	76.0	88.1	86.1	101.4	3.15	4.0	123.0	135.3	140.0	100	E2W	1RA	LSF33	4.450
115	M115	24.0	4"	44.0	5"	86.0	94.1	101.5	110.2	3.15	4.0	133.4	146.7	162.0	115	E2W	1RA	LSF34	6.190
130	M130	24.0	5"	46.8	6"	97.0	110.1	110.2	123.2	3.15	4.0	152.4	160.6	174.0	130	E2W	1RA	LSF35	8.340

*Note : For material options please add the following suffix to change the Ordering Reference ; Brass (no suffix required), Nickel Plated Brass "5", Copper Free Aluminium "1"
 For NPT options add the following digits to the material suffix; 1/2" = 31, 3/4" = 32; 1" = 33; 1 1/4" = 34; 1 1/2" = 35; 2" = 36; 2 1/2" = 37; 3" = 38; 3 1/2" = 39; 4" = 310 (Brass requires prefix '0')

Examples: 32E2W1RA534 = Nickel Plated Brass 1 1/4" NPT, 50SE2W1RA035 = Brass 1 1/2" NPT, 25E2W1RA432 = Stainless Steel 3/4" NPT, 20E2W1RA5 = Nickel Plated Brass M20

Dimensions are displayed in millimetres unless otherwise stated

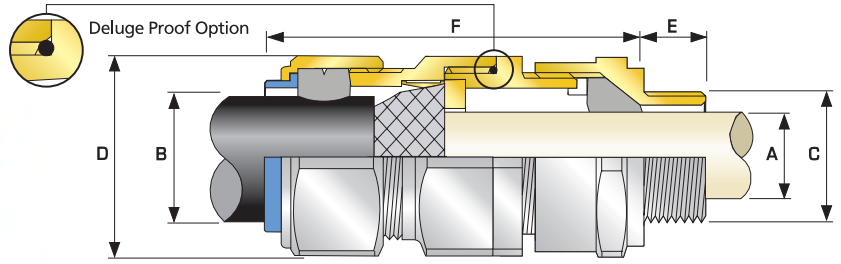

E1X

**E1X Double Seal Industrial Cable Gland
For Braided & Steel Tape Armoured Cables**

- Metal-to-metal armour clamping
- Direct & remote installation
- Permanently crimped, low impedance earth termination
- Secure against self-loosening
- Displacement type inner seal
- Controlled outer 'load retention' seal
- Unique OSTG prevents overtightening
- Deluge protection option
- -60°C to +130°C
- Superior EMC performance



† Grooved Cone (X) is predominantly used for Wire Braid (e.g. GSWB, TCWB), Steel Tape Armour (STA, DSTA) and Aluminium Strip Armour (ASA) but is also suitable for Single Wire Armour (SWA), Aluminium Wire Armour (AWA) and Pliable Wire Armour (PWA) if the range is outside that of the Stepped Cone (W).

Grooved Cone (X) dimensions shown in the Cable Gland Selection Table below are for a double wire strand of braid armour cables. Tapes can also be doubled over. For cables that have only a single layer of armour such as SWA the clamping range should be used as shown in the table below.

If Tape Armour is to be used please contact CMP for advice.

TECHNICAL DATA

Design Specification	BS 6121:Part 1:1989, IEC 62444, EN 62444
Mechanical Classifications*	Impact = Level 8, Cable Anchorage = Class D
Enclosure Protection	IK10 to IEC 62262 (20 joules) Brass & Stainless Steel only
Electrical Classifications*	Category B (Category A when used with braid, tape or pliable wire armour cables)
Marine Approvals	LRS: 01/00171 (E1), ABS: 16-LD1472056-PDA
GOST R Certificate	POCC GB.AF35.H00102
Ingress Protection Rating**	IP66 as standard (IP67, IP68*** available upon request)
Cable Gland Material	Brass, Electroless Nickel Plated Brass, Aluminium
Seal Material	CMP Thermoset Rubber
Cable Type	Wire Braid Armour, Screened Flexible (EMC) Wire Braid (e.g. CY / SY), Pliable Wire Armour (PWA), Steel Tape Armour (STA), Aluminium Strip Armour (e.g. ASA)
Armour Clamping	Detachable Armour Cone & AnyWay Universal Clamping Ring
Sealing Technique	CMP Inner Displacement Seal & Unique CMP 'LRS'™ Outer Load Retention Seal
Sealing Area(s)	Cable Inner Bedding & Outer Cable Sheath

* Mechanical & Electrical Classifications applied as per IEC 62444 & EN 62444

** When CMP installation accessories are used. Refer to page 7 or www.cmp-products.com for further information.

*** IP68 tested to a minimum depth of 30 metres for 12 hours, alternate depths / durations can be provided upon request

Cable Gland Selection Table

Refer to illustration at the top of the page.

Dimensions listed below are for metric cable glands only
Dimensions for alternative threads may vary, please see supplementary technical data sheet

Cable Gland Size	Available Entry Threads "C" (Alternate Metric Thread Lengths Available)					Cable Bedding Diameter "A"		Overall Cable Diameter "B"		Armour Range & Grooved Cone (X)		Across Flats "D"		Across Corners "D"		Protrusion Length "F"	Combined Ordering Reference (*Brass Metric)			Shroud	Cable Gland Weight (Kgs)
	Standard			Option		Min	Max	Min	Max	Min	Max	Max	Max	Size	Type		Ordering Suffix				
	Metric	Thread Length (Metric) "E"	NPT	Thread Length (NPT) "E"	NPT																
20S16	M20	10.0	½"	19.9	¾"	3.1	8.6	6.1	13.1	0.3	1.0	24.0	26.4	72.5	20S16	E1X	1RA	PVC04	0.163		
20S	M20	10.0	½"	19.9	¾"	6.1	11.6	9.5	15.9	0.3	1.0	24.0	26.4	70.0	20S	E1X	1RA	PVC04	0.150		
20	M20	10.0	½"	19.9	¾"	6.5	13.9	12.5	20.9	0.4	1.0	30.5	33.6	73.0	20	E1X	1RA	PVC06	0.210		
25S	M25	10.0	¾"	20.2	1"	11.1	19.9	14.0	22.0	0.4	1.2	37.5	41.3	89.0	25S	E1X	1RA	PVC09	0.330		
25	M25	10.0	¾"	20.2	1"	11.1	19.9	18.2	26.2	0.4	1.2	37.5	41.3	89.0	25	E1X	1RA	PVC09	0.330		
32	M32	10.0	1"	25.0	1 ¼"	17.0	26.2	23.7	33.9	0.4	1.2	46.0	50.6	86.0	32	E1X	1RA	PVC11	0.430		
40	M40	15.0	1 ¼"	25.6	1 ½"	22.0	32.1	27.9	40.4	0.4	1.6	55.0	60.5	90.0	40	E1X	1RA	PVC15	0.620		
50S	M50	15.0	1 ½"	26.1	2"	29.5	38.1	35.2	46.7	0.4	1.6	60.0	66.0	91.0	50S	E1X	1RA	PVC18	0.750		
50	M50	15.0	2"	26.9	2 ½"	35.6	44.0	40.4	53.0	0.6	1.6	70.1	77.1	95.0	50	E1X	1RA	PVC21	0.950		
63S	M63	15.0	2"	26.9	2 ½"	40.1	49.9	45.6	59.4	0.6	1.6	75.0	82.5	102.0	63S	E1X	1RA	PVC23	1.340		
63	M63	15.0	2 ½"	39.9	3"	47.2	55.9	54.6	65.8	0.6	1.6	80.0	88.0	104.0	63	E1X	1RA	PVC25	1.340		
75S	M75	15.0	2 ½"	39.9	3"	52.8	61.9	59.0	72.0	0.6	1.6	90.0	99.0	115.0	75S	E1X	1RA	PVC28	2.110		
75	M75	15.0	3"	41.5	3 ½"	59.1	67.9	66.7	78.4	0.6	1.6	100.0	110.0	117.0	75	E1X	1RA	PVC30	2.420		
90	M90	24.0	3 ½"	42.8	4"	66.6	78.6	76.2	90.3	0.8	1.6	114.3	125.4	147.0	90	E1X	1RA	PVC32	4.210		
100	M100	24.0	4"	44.0	5"	76.0	90.9	86.1	101.4	0.8	1.6	123.0	135.3	140.0	100	E1X	1RA	LSF33	4.450		
115	M115	24.0	4"	44.0	5"	86.0	97.9	101.5	110.2	0.8	1.6	133.4	146.7	162.0	115	E1X	1RA	LSF34	6.190		
130	M130	24.0	5"	46.8	6"	97.0	114.9	110.2	123.2	0.8	1.6	152.4	160.6	174.0	130	E1X	1RA	LSF35	8.340		

*Note : For material options please add the following suffix to change the Ordering Reference ; Brass (no suffix required), Nickel Plated Brass "S", Copper Free Aluminium "1"
For NPT options add the following digits to the material suffix; ½" = 31; ¾" = 32; 1" = 33; 1 ¼" = 34; 1 ½" = 35; 2" = 36; 2 ½" = 37; 3" = 38; 3 ½" = 39; 4" = 310 (Brass requires prefix '0')

Examples: 32E1X1RA534 = Nickel Plated Brass 1 ¼" NPT, 50SE1X1RA035 = Brass 1 ½" NPT, 20E1X1RA5 = Nickel Plated Brass M20

Dimensions are displayed in millimetres unless otherwise stated

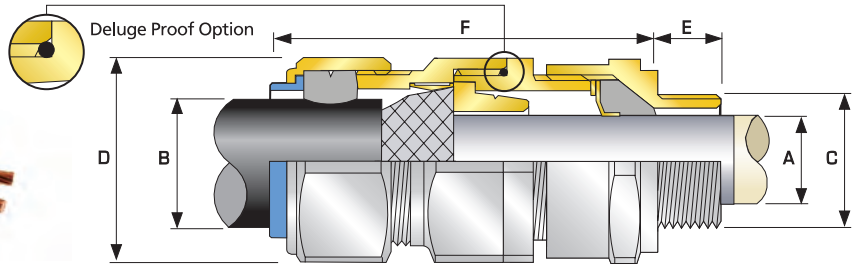

E2X

E2X Double Seal Industrial Cable Gland

For Lead Sheathed Braided Cables

- Effectively earths / grounds lead sheathed cables
- Metal-to-metal armour clamping
- Direct & remote installation
- Permanently crimped, low impedance earth termination
- Secure against self-loosening
- Displacement type inner seal
- Controlled outer 'load retention' seal
- Unique OSTG prevents overtightening
- Deluge protection option
- -60°C to +130°C
- Superior EMC performance



† Grooved Cone (X) is predominantly used for Wire Braid (e.g. GSWB, TCWB), Steel Tape Armour (STA, DSTA) and Aluminium Strip Armour (ASA) but is also suitable for Single Wire Armour (SWA), Aluminium Wire Armour (AWA) and Pliable Wire Armour (PWA) if the range is outside that of the Stepped Cone (W).

Grooved Cone (X) dimensions shown in the Cable Gland Selection Table below are for a double wire strand of braid armoured cables. Tapes can also be doubled over. For cables that have only a single layer of armour such as SWA the clamping range should be used as shown in the table below.

If Tape Armour is to be used please contact CMP for advice.

TECHNICAL DATA	
Design Specification	BS 6121:Part 1:1989, IEC 62444, EN 62444
Mechanical Classifications*	Impact = Level 8, Cable Anchorage = Class D
Enclosure Protection	IK10 to IEC 62262 (20 joules) Brass & Stainless Steel only
Electrical Classifications*	Category B (Category A when used with braid, tape or pliable wire armour cables)
Marine Approvals	LRS: 01/00171 (E1), ABS: 16-LD1472056-PDA
GOST R Certificate	POCC GB.AF35.H00102
Ingress Protection Rating**	IP66 as standard (IP67, IP68*** available upon request)
Cable Gland Material	Brass, Electroless Nickel Plated Brass, Aluminium
Seal Material	CMP Thermoset Rubber
Cable Type	Lead Sheathed & Wire Braid Armour, Lead Sheathed & Steel Tape Armour (LC/STA), Lead Sheathed & Pliable Wire Armour (LC/PWA), Lead Sheathed & Aluminium Strip Armour (LC/ASA)
Armour Clamping	Detachable Armour Cone & AnyWay Universal Clamping Ring
Sealing Technique	CMP Inner Displacement Seal & Unique CMP 'LRS'™ Outer Load Retention Seal
Sealing Area(s)	Cable Inner Lead Sheath & Outer Sheath

* Mechanical & Electrical Classifications applied as per IEC 62444 & EN 62444

** When CMP installation accessories are used. Refer to page 7 or www.cmp-products.com for further information.

*** IP68 tested to a minimum depth of 30 metres for 12 hours, alternate depths / durations can be provided upon request

Cable Gland Selection Table

Refer to illustration at the top of the page.

Dimensions listed below are for metric cable glands only

Dimensions for alternative threads may vary, please see supplementary technical data sheet

Cable Gland Size	Available Entry Threads "C"					Cable Lead Sheath Diameter "A"		Overall Cable Diameter "B"		Armour Range † Grooved Cone (X)		Across Flats "D"		Across Corners "D"		Protrusion Length "F"	Combined Ordering Reference (*Brass Metric)			Shroud	Cable Gland Weight (Kgs)
	Standard			Option													Size	Type	Ordering Suffix		
	Metric	Thread Length (Metric) "E"	NPT	Thread Length (NPT) "E"	NPT	Min	Max	Min	Max	Min	Max	Max	Max								
20S16	M20	10.0	½"	19.9	¾"	3.1	7.8	6.1	13.1	0.3	1.0	24.0	26.4	72.5	20S16	E2X	1RA	PVC04	0.160		
20S	M20	10.0	½"	19.9	¾"	6.1	11.0	9.5	15.9	0.3	1.0	24.0	26.4	70.0	20S	E2X	1RA	PVC04	0.150		
20	M20	10.0	½"	19.9	¾"	6.5	13.4	12.5	20.9	0.4	1.0	30.5	33.6	73.0	20	E2X	1RA	PVC06	0.210		
25S	M25	10.0	¾"	20.2	1"	11.1	19.3	14.0	22.0	0.4	1.2	37.5	41.3	89.0	25S	E2X	1RA	PVC09	0.330		
25	M25	10.0	¾"	20.2	1"	11.1	19.3	18.2	26.2	0.4	1.2	37.5	41.3	89.0	25	E2X	1RA	PVC09	0.330		
32	M32	10.0	1"	25.0	1 ¼"	17.0	25.5	23.7	33.9	0.4	1.2	46.0	50.6	86.0	32	E2X	1RA	PVC11	0.430		
40	M40	15.0	1 ¼"	25.6	1 ½"	22.0	31.2	27.9	40.4	0.4	1.6	55.0	60.5	90.0	40	E2X	1RA	PVC15	0.620		
50S	M50	15.0	1 ½"	26.1	2"	29.5	37.2	35.2	46.7	0.4	1.6	60.0	66.0	91.0	50S	E2X	1RA	PVC18	0.750		
50	M50	15.0	2"	26.9	2 ½"	35.6	42.6	40.4	53.0	0.6	1.6	70.1	77.1	95.0	50	E2X	1RA	PVC21	0.960		
63S	M63	15.0	2"	26.9	2 ½"	40.1	48.5	45.6	59.4	0.6	1.6	75.0	82.5	102.0	63S	E2X	1RA	PVC23	1.350		
63	M63	15.0	2 ½"	39.9	3"	47.2	54.2	54.6	65.8	0.6	1.6	80.0	88.0	104.0	63	E2X	1RA	PVC25	1.350		
75S	M75	15.0	2 ½"	39.9	3"	52.8	60.2	59.0	72.0	0.6	1.6	90.0	99.0	115.0	75S	E2X	1RA	PVC28	2.120		
75	M75	15.0	3"	41.5	3 ½"	59.1	65.2	66.7	78.4	0.6	1.6	100.0	110.0	117.0	75	E2X	1RA	PVC30	2.430		
90	M90	24.0	3 ½"	42.8	4"	66.6	77.1	76.2	90.3	0.8	1.6	114.3	125.4	147.0	90	E2X	1RA	PVC32	4.230		
100	M100	24.0	4"	44.0	5"	76.0	88.1	86.1	101.4	0.8	1.6	123.0	135.3	140.0	100	E2X	1RA	LSF33	4.470		
115	M115	24.0	4"	44.0	5"	86.0	94.1	101.5	110.2	0.8	1.6	133.4	146.7	162.0	115	E2X	1RA	LSF34	6.210		
130	M130	24.0	5"	46.8	6"	97.0	110.1	110.2	123.2	0.8	1.6	152.4	167.6	174.0	130	E2X	1RA	LSF35	8.360		

*Note : For material options please add the following suffix to change the Ordering Reference : Brass (no suffix required), Nickel Plated Brass "5", Copper Free Aluminium "1" For NPT options add the following digits to the material suffix; ½" = 31; ¾" = 32; 1" = 33; 1 ¼" = 34; 1 ½" = 35; 2" = 36; 2 ½" = 37; 3" = 38; 3 ½" = 39; 4" = 310 (Brass requires prefix '0')

Examples: 32E2X1RA534 = Nickel Plated Brass 1 ¼" NPT, 50SE2X1RA035 = Brass 1 ½" NPT, 20E2X1RA5 = Nickel Plated Brass M20

Dimensions are displayed in millimetres unless otherwise stated



CMP SOLO - LOW SMOKE & FUME RANGE





SOLO Low Smoke & Fume Cable Glands

The outstanding safety benefits of low smoke and fume (LSF) or halogen free cable materials have already led to their increased use in areas considered to be potentially at risk in situations of fire hazard. Typical examples are in tunnels, deep bore underground metro systems, and public buildings where the risk of smoke inhalation in the event of fire is at its greatest.

The CMP SOLO LSF range of Cable Glands and accessories meet the most stringent requirements and provide a single, simple solution for specifiers and users in meeting LSF and Halogen Free requirements.

The CMP SOLO LSF option can be provided for all types of Cable Glands shown in this catalogue.

CMP SOLO LSF Cable Glands meet the requirements of the London Underground Fire Safety Regulations and as such, they are LUL approved for use within the London Underground network.

Add LSF2RA after the gland size and type e.g. 25CWLSF2RA to denote that a Gland Kit is required.

All Cable Glands shown in Nickel Plated Brass, alternative materials are available.

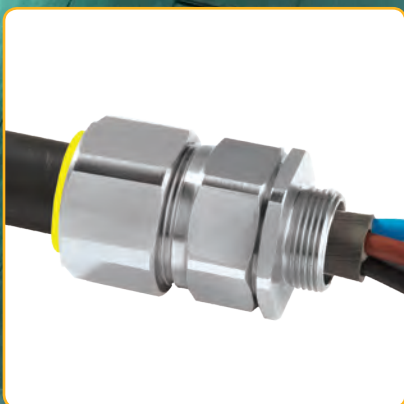

SOLO[™]



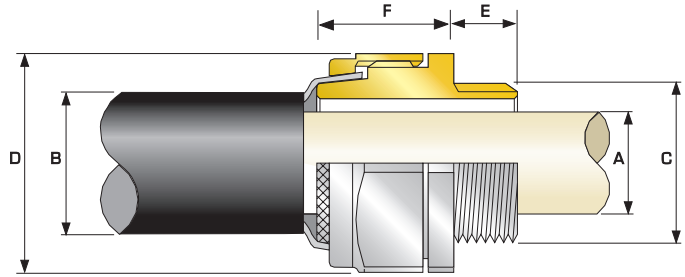
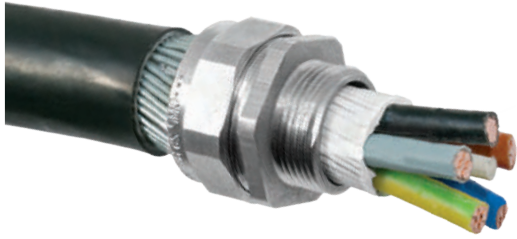

BW SOLO

BW Industrial Cable Gland SOLO LSF Kit

For all types of Steel & Aluminium Wire Armoured Cables

- Direct & remote installation
- -60°C to +200°C
- Superior EMC performance
- LUL (London Underground) approved



Ordering suffix '2RA' includes locknut, earth tag & shroud
Other kit options available



TECHNICAL DATA

Type	BW SOLO-Kit
Design Specification	BS 6121 : Part 1:1989
Mechanical Classifications*	Impact = Level 8, Cable Anchorage = Class D
Enclosure Protection	IK10 to IEC 62262 (20 joules) Brass & Stainless Steel only
Electrical Classifications*	Category B
Marine Approvals	LRS: 01/00171 (E1), ABS: 16-LD1472056-PDA
GOST R Certificate	POCC GB.A735.H00102
Ingress Protection Rating**	IP2X
Cable Gland Material	Brass, Electroless Nickel Plated Brass
Cable Type	Single Wire Armour (SWA), Aluminium Wire Armour (AWA)
Armour Clamping	Two Part Armour Lock
Cable Gland Kits Available	Up to & including size 25 - 2 glands, 2 locknuts, 2 earth tags & 2 LSF shrouds Size 32 & above - 1 gland, 1 locknut, 1 earth tag & 1 LSF shroud

* Mechanical & Electrical Classifications applied as per IEC 62444 & EN 62444
As IEC 62444 and EN 62444 do not cover cable glands which are supplied without cable sealing rings, the information provided here is for information only.
** When CMP installation accessories are used. Refer to page 7 or www.cmp-products.com for further information.

Cable Gland Selection Table

Refer to illustration at the top of the page.

Cable Gland Size	Available Entry Threads "C" (Alternate Metric Thread Lengths Available)		Cable Bedding Diameter "A"	Overall Cable Diameter "B"	Armour Range		Across Flats "D"	Across Corners "D"	Protrusion Length "F" (Without Shroud)	Combined Ordering Reference (*Brass Metric)			Cable Gland Only Weight (Kgs)
	Metric	Thread Length (Metric) "E"			Max	Max				Min	Max	Max	
			Standard	Max			Max	Max	Max				
20S	M20	10.0	11.7	15.8	0.8	1.25	22.0	24.2	18.5	20S	BWLSF	2RA	0.052
20	M20	10.0	14.0	21.1	0.8	1.25	28.0	30.8	22.5	20	BWLSF	2RA	0.088
25	M25	10.0	20.0	27.2	1.25	1.6	33.0	36.3	21.5	25	BWLSF	2RA	0.110
32	M32	10.0	26.3	34.1	1.6	2.0	41.0	45.1	22.5	32	BWLSF	2RA	0.149
40	M40	15.0	32.2	42.4	1.6	2.0	50.0	55.0	30.0	40	BWLSF	2RA	0.316
50S	M50	15.0	38.2	50.1	2.0	2.5	57.1	62.8	30.0	50S	BWLSF	2RA	0.468
50	M50	15.0	44.1	55.7	2.0	2.5	65.0	71.5	32.0	50	BWLSF	2RA	0.477
63S	M63	15.0	50.0	62.4	2.0	2.5	75.0	82.5	41.3	63S	BWLSF	2RA	0.632
63	M63	15.0	56.0	68.2	2.0	2.5	79.0	86.9	41.3	63	BWLSF	2RA	0.890
75S	M75	15.0	62.0	76.8	2.0	2.5	89.0	97.9	47.6	75S	BWLSF	2RA	1.268
75	M75	15.0	68.0	82.9	2.5	3.0	95.0	104.5	49.6	75	BWLSF	2RA	1.400

*For material options add the following suffix to the Ordering Reference; Brass (no suffix required); Nickel Plated Brass 'S'

Examples: 32BWLSF1RA5 = Nickel Plated Brass

Dimensions are displayed in millimetres unless otherwise stated

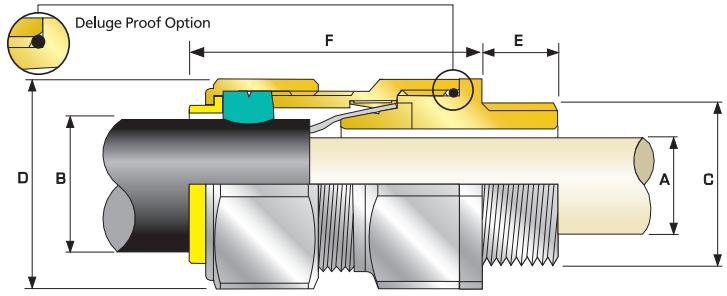

CW Industrial Single Seal Cable Gland SOLO LSF Kit

For all types of Steel & Aluminium Wire Armoured Cables

- Metal-to-metal armour clamping
- Direct & remote installation
- Controlled outer 'load retention' seal
- Unique OSTG prevents overtightening
- -60°C to +130°C
- Deluge protection option
- Superior EMC performance
- LUL (London Underground) approved



Ordering suffix '2RA' includes locknut, earth tag & shroud
Other kit options available



Gland Kit shown as example

TECHNICAL DATA	
Type	CW SOLO-Kit
Design Specification	BS 6121 :Part 1:1989, IEC 62444, EN 62444
Mechanical Classifications*	Impact = Level 8, Cable Anchorage = Class D
Enclosure Protection	IK10 to IEC 62262 (20 joules) Brass & Stainless Steel only
Electrical Classifications*	Category B
Marine Approvals	LRS: 01/00171 (E1), ABS: 16-LD1472056-PDA
GOST R Certificate	POCC GB.AF35.H00102
Ingress Protection Rating**	IP66
Cable Gland Material	Brass, Electroless Nickel Plated Brass, Stainless Steel, Aluminium
Seal Material	CMP SOLO LSF Halogen Free Thermoset Elastomer
Cable Type	Single Wire Armour (SWA), Aluminium Wire Armour (AWA)
Armour Clamping	Detachable Armour Cone & AnyWay Universal Clamping Ring
Sealing Technique	Unique CMP 'LRS' Outer Seal (Load Retention Seal)
Sealing Area(s)	Cable Outer Sheath
Cable Gland Kits Available	Up to & including size 25 - 2 glands, 2 locknuts, 2 earth tags & 2 LSF shrouds Size 32 & above - 1 gland, 1 locknut, 1 earth tag & 1 LSF shroud

* Mechanical & Electrical Classifications applied as per IEC 62444 & EN 62444
** When CMP installation accessories are used. Refer to page 7 or www.cmp-products.com for further information.

Cable Gland Selection Table

Refer to illustration at the top of the page.

Cable Gland Size	Entry Thread "C"	Thread Length (Metric) "E"	Cable Bedding Diameter "A"	Overall Cable Diameter "B"		Armour Range		Across Flats "D"	Across Corners "D"	Protrusion Length "F" (Without Shroud)	Combined Ordering Reference (*Brass Metric)			Cable Gland Only Weight (Kgs)
				Max	Min	Min	Max				Max	Max	Ordering Suffix	
20S16	M20	10.0	8.7	6.1	13.1	0.8	1.25	24.0	26.4	48.0	20S16	CWLSF	2RA	0.100
20S	M20	10.0	11.7	9.5	15.9	0.8	1.25	24.0	26.4	48.0	20S	CWLSF	2RA	0.100
20	M20	10.0	14.0	12.5	20.9	0.8	1.25	30.5	33.6	48.0	20	CWLSF	2RA	0.147
25	M25	10.0	20.0	18.2	26.2	1.25	1.6	37.5	41.3	56.0	25	CWLSF	2RA	0.224
32	M32	10.0	26.3	23.7	33.9	1.6	2.0	46.0	50.6	54.0	32	CWLSF	2RA	0.306
40	M40	15.0	32.2	27.9	40.4	1.6	2.0	55.0	60.5	58.0	40	CWLSF	2RA	0.448
50S	M50	15.0	38.2	35.2	46.7	2.0	2.5	60.0	66.0	61.0	50S	CWLSF	2RA	0.567
50	M50	15.0	44.1	40.4	53.0	2.0	2.5	70.1	77.1	60.0	50	CWLSF	2RA	0.751
63S	M63	15.0	50.0	45.6	59.4	2.0	2.5	75.0	82.5	74.0	63S	CWLSF	2RA	1.036
63	M63	15.0	56.0	54.6	65.8	2.0	2.5	80.0	88.0	71.0	63	CWLSF	2RA	1.016
75S	M75	15.0	62.0	59.0	72.0	2.0	2.5	90.0	99.0	86.0	75S	CWLSF	2RA	1.787
75	M75	15.0	64.2	66.7	78.4	2.5	3.0	100.0	110.0	82.0	75	CWLSF	2RA	2.091

*For material options add the following suffix to the Ordering Reference: Brass (no suffix required); Nickel Plated Brass '5'; 316 Grade Stainless Steel '4'; Copper Free Aluminium '1'
For NPT options add the following digits to the material suffix; 1/2" = 31; 3/4" = 32; 1" = 33; 1 1/4" = 34; 1 1/2" = 35; 2" = 36; 2 1/2" = 37; 3" = 38; 3 1/2" = 39; 4" = 310 (Brass requires prefix '0')

Examples: 20CWLSF2RA5 = Nickel Plated Brass M20, 50 CWLSF2RA = Brass 50mm, 25CWLSF2RA4 = Stainless Steel 25mm

Dimensions are displayed in millimetres unless otherwise stated

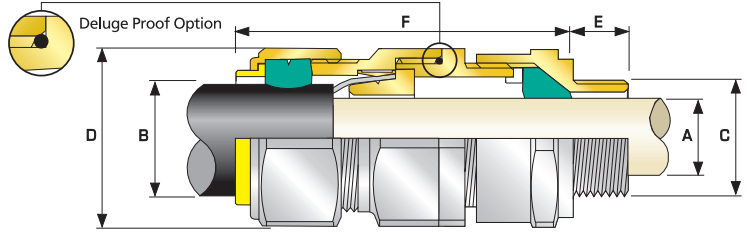

E1W SOLO

E1W Industrial Double Seal Cable Gland SOLO LSF Kit

For all types of Steel & Aluminium Wire Armoured Cables

- Metal-to-metal armour clamping
- Direct & remote installation
- Displacement type inner seal
- Controlled outer 'load retention' seal
- Unique OSTG prevents overtightening
- Deluge protection option
- -60°C to +130°C
- Superior EMC performance
- LUL (London Underground) approved



Ordering suffix '2RA' includes locknut, earth tag & shroud
Other kit options available



TECHNICAL DATA

Type	E1W SOLO-Kit
Design Specification	BS 6121:Part 1:1989, IEC 62444, EN 62444
Mechanical Classifications*	Impact = Level 8, Cable Anchorage = Class D
Enclosure Protection	IK10 to IEC 62262 (20 joules) Brass & Stainless Steel only
Electrical Classifications*	Category B
Marine Approvals	LRS: 01/00171 (E1), ABS: 16-LD1472056-PDA
Ingress Protection Rating**	IP66 as standard (IP67, IP68*** available upon request)
Cable Gland Material	Brass, Electroless Nickel Plated Brass, Aluminium
Seal Material	CMP SOLO LSF Halogen Free Thermoset Elastomer
Cable Type	Single Wire Armour (SWA), Aluminium Wire Armour (AWA)
Armour Clamping	Detachable Armour Cone & AnyWay Universal Clamping Ring
Sealing Technique	CMP Inner Displacement Seal & Unique CMP 'LRS'™ Outer Load Retention Seal
Sealing Area(s)	Cable Inner Bedding & Outer Cable Sheath
Cable Gland Kits Available	Up to & including size 25 - 2 glands, 2 locknuts, 2 earth tags & 2 LSF shrouds Size 32 & above - 1 gland, 1 locknut, 1 earth tag & 1 LSF shroud

* Mechanical & Electrical Classifications applied as per IEC 62444 & EN 62444

** When CMP installation accessories are used. Refer to page 7 or www.cmp-products.com for further information.

*** IP68 tested to a minimum depth of 30 metres for 12 hours, alternate depths / durations can be provided upon request

Cable Gland Selection Table

Refer to illustration at the top of the page.

Dimensions listed below are for metric cable glands only
Dimensions for alternative threads may vary, please see supplementary technical data sheet

Cable Gland Size	Available Entry Threads "C" (Alternate Metric Thread Lengths Available)					Cable Bedding Diameter "A"		Overall Cable Diameter "B"		Armour Range		Across Flats "D"	Across Corners "D"	Protrusion Length "F" (Without Shroud)	Combined Ordering Reference (*Brass Metric)			Cable Gland Only Weight (Kgs)
	Standard			Option											Size	Type	Ordering Suffix	
	Metric	Thread Length (Metric) "E"	NPT	Thread Length (Metric) "E"	NPT	Min	Max	Min	Max	Min	Max	Max	Max					
20S16	M20	10.0	½"	19.9	¾"	3.1	8.6	6.1	13.1	0.8	1.25	24.0	26.4	72.5	20S16	E1WLSF	2RA	0.163
20S	M20	10.0	½"	19.9	¾"	6.1	11.6	9.5	15.9	0.8	1.25	24.0	26.4	70.0	20S	E1WLSF	2RA	0.150
20	M20	10.0	½"	19.9	¾"	6.5	13.9	12.5	20.9	0.8	1.25	30.5	33.6	73.0	20	E1WLSF	2RA	0.210
25S	M25	10.0	¾"	20.2	1"	11.1	19.9	14.0	22.0	1.25	1.6	37.5	41.3	89.0	25S	E1WLSF	2RA	0.330
25	M25	10.0	¾"	20.2	1"	11.1	19.9	18.2	26.2	1.25	1.6	37.5	41.3	89.0	25	E1WLSF	2RA	0.330
32	M32	10.0	1"	25.0	1 ¼"	17.0	26.2	23.7	33.9	1.6	2.0	46.0	50.6	86.0	32	E1WLSF	2RA	0.430
40	M40	15.0	1 ½"	25.6	1 ½"	22.0	32.1	27.9	40.4	1.6	2.0	55.0	60.5	90.0	40	E1WLSF	2RA	0.620
50S	M50	15.0	1 ½"	26.1	2"	29.5	38.1	35.2	46.7	2.0	2.5	60.0	66.0	91.0	50S	E1WLSF	2RA	0.750
50	M50	15.0	2"	26.9	2 ½"	35.6	44.0	40.4	53.0	2.0	2.5	70.1	77.1	95.0	50	E1WLSF	2RA	0.950
63S	M63	15.0	2"	26.9	2 ½"	40.1	49.9	45.6	59.4	2.0	2.5	75.0	82.5	102.0	63S	E1WLSF	2RA	1.340
63	M63	15.0	2 ½"	39.9	3"	47.2	55.9	54.6	65.8	2.0	2.5	80.0	88.0	104.0	63	E1WLSF	2RA	1.340
75S	M75	15.0	2 ½"	39.9	3"	52.8	61.9	59.0	72.0	2.0	2.5	90.0	99.0	115.0	75S	E1WLSF	2RA	2.110
75	M75	15.0	3"	41.5	3 ½"	59.1	67.9	66.7	78.4	2.5	3.0	100.0	110.0	117.0	75	E1WLSF	2RA	2.420
90	M90	24.0	3 ½"	42.8	4"	66.6	78.6	76.2	90.3	3.15	4.0	114.3	125.4	147.0	90	E1WLSF	2RA	4.210
100	M100	24.0	4"	44.0	5"	76.0	90.9	86.1	101.4	3.15	4.0	123.0	135.3	140.0	100	E1WLSF	2RA	4.450
115	M115	24.0	4"	44.0	5"	86.0	97.9	101.5	110.2	3.15	4.0	133.4	146.7	162.0	115	E1WLSF	2RA	6.190
130	M130	24.0	5"	46.8	6"	97.0	114.9	110.2	123.2	3.15	4.0	152.4	167.6	174.0	130	E1WLSF	2RA	8.340

*For material options add the following suffix to the Ordering Reference; Brass (no suffix required); Nickel Plated Brass 'S'; 316 Grade Stainless Steel '4'; Copper Free Aluminium '1'
For NPT options add the following digits to the material suffix; ½" = 31; ¾" = 32; 1" = 33; 1 ¼" = 34; 1 ½" = 35; 2" = 36; 2 ½" = 37; 3" = 38; 3 ½" = 39; 4" = 310 (Brass requires prefix '0')

Examples: 32E1WLSF2RA5 = Nickel Plated Brass, 32E1WLSF2RA1 = Copper Free Aluminium, 20E1WLSF2RA5 = Nickel Plated Brass M20

Dimensions are displayed in millimetres unless otherwise stated

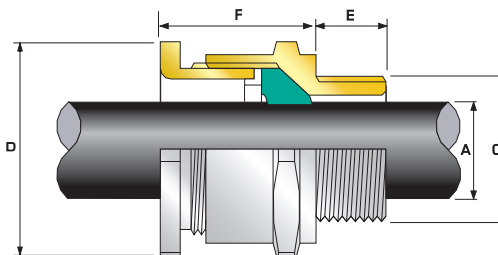
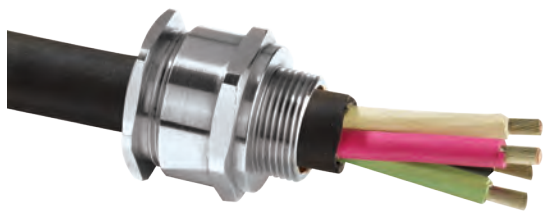

A2 SOLO

A2 Industrial Single Seal Cable Gland SOLO LSF Kit

For all types of Unarmoured & Braided Cables

- Displacement type seal
- Deluge protected
- -60°C to +130°C
- LUL (London Underground) approved



Ordering suffix '2RA' includes locknut & shroud
Other kit options available



Gland Kit shown as example

TECHNICAL DATA	
Type	A2 SOLO-Kit
Design Specification	BS 6121:Part 1:1989, IEC 62444, EN 62444
Mechanical Classifications*	Impact = Level 8, Cable Anchorage = Class D
Enclosure Protection	IK10 to IEC 62262 (20 joules) Brass & Stainless Steel only
Marine Approvals	LRs: 01/00171 (E1), ABS: 16-LD1472056-PDA
GOST R Certificate	POCC GB.AF35.H00102
Ingress Protection Rating**	IP66, IP67 & IP68***
Deluge Protection Compliance	DTS01 : 91
Cable Gland Material	Brass, Electroless Nickel Plated Brass, Stainless Steel, Aluminium
Seal Material	CMP SOLO LSF Halogen Free Thermoset Elastomer
Cable Type	Unarmoured
Sealing Technique	CMP Unique Displacement Seal
Sealing Area(s)	Cable Outer Sheath
Cable Gland Kits Available	Up to & including size 25 - 2 glands, 2 locknuts & 2 LSF shrouds Size 32 & above - 1 gland, 1 locknut & 1 LSF shroud

* Mechanical & Electrical Classifications applied as per IEC 62444 & EN 62444
** When CMP installation accessories are used. Refer to page 7 or www.cmp-products.com for further information.
*** IP68 tested to a minimum depth of 30 metres for 12 hours, alternate depths / durations can be provided upon request

Cable Gland Selection Table

Refer to illustration at the top of the page.

Dimensions listed below are for metric cable glands only
Dimensions for alternative threads may vary, please see supplementary technical data sheet

Cable Gland Size	Available Entry Threads "C" (Alternate Metric Thread Lengths Available)					Overall Cable Diameter "A"		Across Flats "D"	Across Corners "D"	Protrusion Length "F" (Without Shroud)	Combined Ordering Reference (*Brass Metric)			Cable Gland Only Weight (Kgs)
	Standard			Option							Size	Type	Ordering Suffix	
	Metric	Thread Length (Metric) "E"	NPT	Thread Length (NPT) "E"	NPT	Min	Max	Max	Max					
20S16	M20	10.0	½"	19.9	¾"	3.2	8.7	24.0	26.4	25.1	20S16	A2LSF	2RA	0.070
20S	M20	10.0	½"	19.9	¾"	6.1	11.7	24.0	26.4	25.1	20S	A2LSF	2RA	0.060
20	M20	10.0	½"	19.9	¾"	6.5	14.0	27.0	29.7	27.2	20	A2LSF	2RA	0.070
25	M25	10.0	¾"	20.2	1"	11.1	20.0	36.0	39.6	35.5	25	A2LSF	2RA	0.130
32	M32	10.0	1"	25.0	1 ¼"	17.0	26.3	41.0	45.1	34.2	32	A2LSF	2RA	0.150
40	M40	15.0	1 ¼"	25.6	1 ½"	23.5	32.2	50.0	55.0	35.1	40	A2LSF	2RA	0.200
50S	M50	15.0	1 ½"	26.1	2"	31.0	38.2	55.0	60.5	32.0	50S	A2LSF	2RA	0.260
50	M50	15.0	2"	26.9	2 ½"	35.6	44.0	60.0	66.0	36.3	50	A2LSF	2RA	0.270
63S	M63	15.0	2"	26.9	2 ½"	41.5	49.9	70.5	77.6	33.5	63S	A2LSF	2RA	0.430
63	M63	15.0	2 ½"	39.9	3"	47.2	55.9	75.0	82.5	35.8	63	A2LSF	2RA	0.460
75S	M75	15.0	2 ½"	39.9	3"	54.0	61.9	80.0	88.0	34.2	75S	A2LSF	2RA	0.520
75	M75	15.0	3"	41.5	3 ½"	61.1	67.9	84.0	92.4	40.6	75	A2LSF	2RA	0.500
90	M90	24.0	3 ½"	42.8	4"	66.6	79.9	108.0	118.8	58.3	90	A2LSF	2RA	1.600
100	M100	24.0	4"	44.0	5"	76.0	91.0	123.0	135.3	55.2	100	A2LSF	2RA	1.780
115	M115	24.0	4"	44.0	5"	86.0	97.9	133.4	146.7	65.2	115	A2LSF	2RA	2.670
130	M130	24.0	5"	46.8	6"	97.0	114.9	152.4	167.6	73.9	130	A2LSF	2RA	3.800

*For material options add the following suffix to the Ordering Reference: Brass (no suffix required); Nickel Plated Brass '5'; 316 Grade Stainless Steel '4'; Copper Free Aluminium '1'
For NPT options add the following digits to the material suffix; ½" = 31; ¾" = 32; 1" = 33; 1 ¼" = 34; 1 ½" = 35; 2" = 36; 2 ½" = 37; 3" = 38; 3 ½" = 39; 4" = 310 (Brass requires prefix '0')

Examples: 32A2LSF2RA534 = Nickel Plated Brass 1 ¼" NPT, 50SA2LSF2RA035 = Brass 1 ½" NPT, 25A2LSF2RA432 = Stainless Steel ¾" NPT, 20A2LSF2RA5 = Nickel Plated Brass M20

Dimensions are displayed in millimetres unless otherwise stated



CMP CIEL - CAST INTEGRAL EARTH LUG EQUIPPED PRODUCTS





CIEL Cast Integral Earth Lug Cable Glands

The CMP Cast Integral Earth Lug (CIEL) concept is intended for external earth connections where it is essential to maintain critical earthing under high level short circuit fault conditions. It is designed to meet I.E.E. earthing regulations and because of its unique design, is particularly suitable for medium voltage and high voltage installations where low resistance earthing is essential.

CMP CIEL Cable Glands have been subjected to independent third party short circuit tests to determine their short circuit fault current ratings resulting in the following:

Symmetrical Fault Current (kA) for 1 second

- 26.0 kA for Cable Gland sizes up to 40
- 43.0 kA for Cable Gland sizes 50S and above

The CMP cast integral earth lug (CIEL) option is available in various gland types including BWL-CIEL, CW-CIEL, E1W-CIEL and E2W-CIEL. Other options are available on request including versions for Explosive Atmosphere installations, such as E1FW-CIEL and E2FW-CIEL.

Please state Cable Gland type and size e.g. 25CWC1RA, where the suffix letter 'C' is used to identify the product type CIEL.

All Cable Glands shown in Nickel Plated Brass, alternative materials are available.

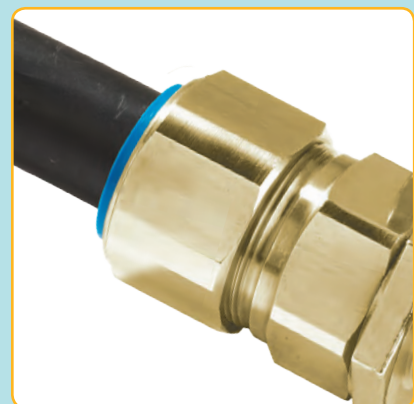
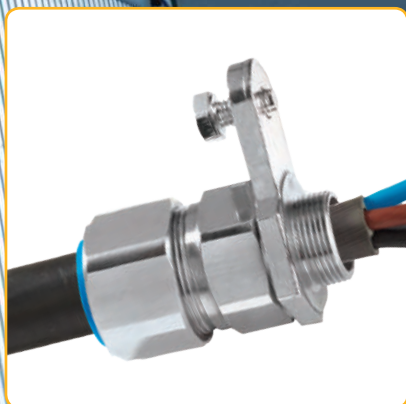

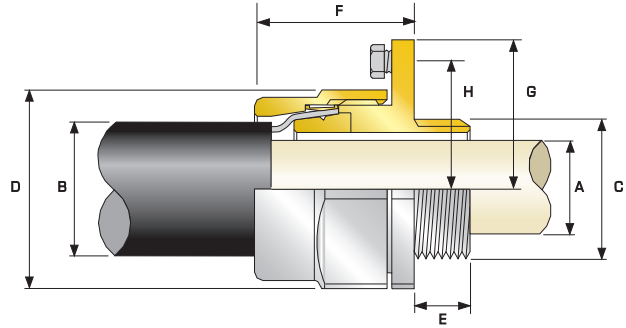
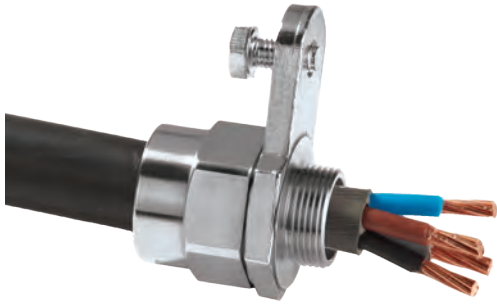

BWL CIEL

BWL Heavy Duty Industrial Cast Integral Earth Lug Cable Gland

For all types of Steel & Aluminium Wire Armoured Cables

- External earth connection
- Third party short circuit tested
- Metal-to-metal armour clamping
- Direct & remote installation
- Robust, heavy duty design
- Permanently crimped, low impedance earth termination
- Secure against self-loosening
- Longer body protects armour wires from impact
- -60°C to +200°C
- Superior EMC performance



The Symmetrical Fault Current (kA) rating for 1 second applicable to the Cast Integral Earth Lug featured in the BWL CIEL products are as follows:
 26.0 kA for Cable Gland sizes up to 40
 43.0 kA for Cable Gland sizes 50S and above.

TECHNICAL DATA	
Design Specification	BS 6121 : Part 1: 1989
Mechanical Classifications*	Impact = Level 8, Cable Anchorage = Class B
Enclosure Protection	IK10 to IEC 62262 (20 joules)
Electrical Classifications*	Category C
Marine Approvals	LRS: 01/00171 (E1), ABS: 16-LD1472056-PDA
GOST R Certificate	POCC GB.A135.H00102
Ingress Protection Rating**	IP2X
Cable Gland Material	Brass, Electroless Nickel Plated Brass
Cable Type	Single Wire Armour (SWA), Aluminium Wire Armour (AWA)
Armour Clamping	Armour Cone & AnyWay Universal Clamping Ring

* Mechanical & Electrical Classifications applied as per IEC 62444 & EN 62444
 As IEC 62444 and EN 62444 do not cover cable glands which are supplied without cable sealing rings, the information provided here is for information only, since this product does not fully conform to these standards.
 ** When CMP installation accessories are used. Refer to page 7 or www.cmp-products.com for further information.

Cable Gland Selection Table

Refer to illustration at the top of the page.

Cable Gland Size	Available Entry Threads "C" (Alternate Metric Thread Lengths Available)		Cable Bedding Diameter "A"	Overall Cable Diameter "B"	Armour Range		Across Flats "D"	Across Corners "D"	Protrusion Length "F"	Nominal Radius Dimension		CIEL Earth Bolt Size	Earth Fault Current Rating (kA)	Combined Ordering Reference (*Brass Metric)			Cable Gland Weight (Kgs)
	Standard	Thread Length (Metric) "E"			Min	Max				"H"	"G"			Size	Type	Ordering Suffix	
	Metric		Max	Max	Min	Max	Max	Max									
20S	M20	10.0	11.7	15.9	0.8	1.25	24.0	26.4	32.2	28.6	38.6	M8	26.0	20S	BWLC	1RA	0.112
20	M20	10.0	14.0	20.9	0.8	1.25	30.5	33.6	30.6	31.8	41.8	M8	26.0	20	BWLC	1RA	0.158
25	M25	10.0	20.0	26.2	1.25	1.6	37.5	41.3	36.4	38.1	50.8	M8	26.0	25	BWLC	1RA	0.224
32	M32	10.0	26.2	33.9	1.6	2.0	46.0	50.6	32.6	41.3	54.0	M8	26.0	32	BWLC	1RA	0.244
40	M40	15.0	32.2	40.4	1.6	2.0	55.0	60.5	36.9	50.8	68.3	M10	26.0	40	BWLC	1RA	0.538
50S	M50	15.0	38.2	46.7	2.0	2.5	60.0	66.0	39.6	57.2	74.6	M12	43.0	50S	BWLC	1RA	0.670
50	M50	15.0	44.1	53.1	2.0	2.5	70.1	77.1	39.1	60.3	79.4	M12	43.0	50	BWLC	1RA	0.718
63S	M63	15.0	50.0	59.4	2.0	2.5	75.0	82.5	52.0	70.0	90.5	M12	43.0	63S	BWLC	1RA	1.226
63	M63	15.0	56.0	65.9	2.0	2.5	80.0	88.0	49.8	70.0	90.5	M12	43.0	63	BWLC	1RA	1.178
75S	M75	15.0	62.0	72.1	2.0	2.5	90.0	99.0	63.7	76.2	98.5	M12	43.0	75S	BWLC	1RA	1.859
75	M75	15.0	68.0	78.5	2.5	3.0	100.0	110.0	57.3	82.6	108.0	M12	43.0	75	BWLC	1RA	2.054
90	M90	24.0	79.0	90.4	3.15	4.0	114.3	125.7	66.0	95.3	108.0	M12	43.0	90	BWLC	1RA	2.926
100	M100	24.0	90.0	101.5	3.15	4.0	123.0	135.3	80.0	101.6	139.7	M12	43.0	100	BWLC	1RA	3.032
115	M115	24.0	98.0	110.3	3.15	4.0	133.4	146.7	98.0	112.0	138.5	M12	43.0	115	BWLC	1RA	4.066
130	M130	24.0	115.0	123.3	3.15	4.0	152.4	167.6	110.0	112.0	138.5	M12	43.0	130	BWLC	1RA	5.245

*For material options add the following suffix to the Ordering Reference; Brass (no suffix required); Nickel Plated Brass '5'; 316 Grade Stainless Steel '4'; Copper Free Aluminium '1'

Examples: 32BWL1RA5 = Nickel Plated Brass, 25BWL1RA4 = Stainless Steel

Dimensions are displayed in millimetres unless otherwise stated

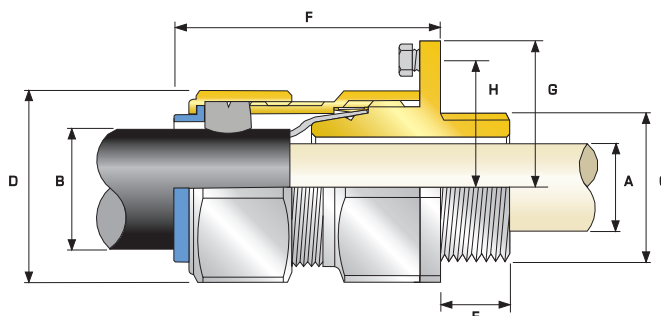

CW CIEL

CW Industrial Single Seal Cast Integral Earth Lug Cable Gland

For all types of Steel & Aluminium Wire Armoured Cables

- External earth connection
- Third party short circuit tested
- Metal-to-metal armour clamping
- Direct & remote installation
- Controlled outer 'load retention' seal
- Unique OSTG prevents overtightening
- Permanently crimped, low impedance earth termination
- Secure against self-loosening
- -60°C to +130°C
- Deluge protection option
- Superior EMC performance



The Symmetrical Fault Current (kA) rating for 1 second applicable to the Cast Integral Earth Lug featured in the CW CIEL products are as follows:
 26.0 kA for Cable Gland sizes up to 40
 43.0 kA for Cable Gland sizes 50S and above.

TECHNICAL DATA	
Design Specification	BS 6121 :Part 1:1989, EN 62444, IEC 62444
Mechanical Classifications*	Impact = Level 8, Cable Anchorage = Class D
Enclosure Protection	IK10 to IEC 62262 (20 joules) Brass & Stainless Steel only
Electrical Classifications*	Category C
Marine Approvals	LRS: 01/00171 (E1), ABS: 16-LD1472056-PDA
GOST R Certificate	POCC GB.AГ35.H00102
Ingress Protection Rating**	IP66
Cable Gland Material	Brass, Electroless Nickel Plated Brass, Stainless Steel, Aluminium
Seal Material	CMP Thermoset Rubber
Cable Type	Single Wire Armour (SWA), Aluminium Wire Armour (AWA)
Armour Clamping	Detachable Armour Cone & AnyWay Universal Clamping Ring
Sealing Technique	Unique CMP 'LRS' Outer Seal (Load Retention Seal)
Sealing Area(s)	Cable Outer Sheath

* Mechanical & Electrical Classifications applied as per IEC 62444 & EN 62444
 ** When CMP installation accessories are used. Refer to page 7 or www.cmp-products.com for further information.

Cable Gland Selection Table

Refer to illustration at the top of the page.

Cable Gland Size	Entry Thread "C"	Thread Length "E"	Cable Bedding Diameter "A"		Overall Cable Diameter "B"		Armour Range		Across Flats "D"	Across Corners "D"	Protrusion Length "F"	Nominal Radius Dimension		CIEL Earth Bolt Size	Earth Fault Current Rating (kA)	Combined Ordering Reference (*Brass Metric)			Cable Gland Weight (Kgs)
			Max	Min	Max	Min	Max	Max				Max	"H"			"G"	Size	Type	
20S	M20	10.0	11.7	9.5	15.9	0.8	1.25	24.0	26.4	48.0	28.6	38.6	M8	26.0	20S	CWC	1RA	0.195	
20	M20	10.0	14.0	12.5	20.9	0.8	1.25	30.5	33.6	48.0	31.8	41.3	M8	26.0	20	CWC	1RA	0.276	
25S	M25	10.0	20.0	14.0	22.0	1.25	1.6	37.5	41.3	56.0	38.1	50.8	M8	26.0	25S	CWC	1RA	0.436	
25	M25	10.0	20.0	18.2	26.2	1.25	1.6	37.5	41.3	56.0	38.1	50.8	M8	26.0	25	CWC	1RA	0.435	
32	M32	10.0	26.2	23.7	33.9	1.6	2.0	46.0	50.6	54.0	41.3	54.0	M8	26.0	32	CWC	1RA	0.506	
40	M40	15.0	32.2	27.9	40.4	1.6	2.0	55.0	60.5	58.0	50.8	68.3	M10	26.0	40	CWC	1RA	0.802	
50S	M50	15.0	38.2	35.2	46.7	2.0	2.5	60.0	66.0	61.0	57.2	74.6	M12	43.0	50S	CWC	1RA	0.883	
50	M50	15.0	44.1	40.4	53.0	2.0	2.5	70.1	77.1	60.0	60.3	79.4	M12	43.0	50	CWC	1RA	1.088	
63S	M63	15.0	50.0	45.6	59.4	2.0	2.5	75.0	82.5	74.0	70.0	90.5	M12	43.0	63S	CWC	1RA	1.636	
63	M63	15.0	56.0	54.6	65.8	2.0	2.5	80.0	88.0	71.0	70.0	90.5	M12	43.0	63	CWC	1RA	1.597	
75S	M75	15.0	62.0	59.0	72.0	2.0	2.5	90.0	99.0	86.0	76.2	98.5	M12	43.0	75S	CWC	1RA	2.310	
75	M75	15.0	68.0	66.7	78.4	2.5	3.0	100.0	110.0	82.0	82.6	108.0	M12	43.0	75	CWC	1RA	2.717	
90	M90	24.0	79.0	76.2	90.3	3.15	4.0	114.3	125.7	95.0	95.3	107.1	M12	43.0	90	CWC	1RA	4.417	
100	M100	24.0	90.0	86.1	101.4	3.15	4.0	123.0	135.3	95.0	101.6	139.7	M12	43.0	100	CWC	1RA	4.820	
115	M115	24.0	98.0	101.5	110.2	3.15	4.0	133.4	146.7	107.5	112.0	138.5	M12	43.0	115	CWC	1RA	6.191	
130	M130	24.0	115.0	110.2	123.2	3.15	4.0	152.4	167.6	110.0	112.0	138.5	M12	43.0	130	CWC	1RA	8.388	

*For material options add the following suffix to the Ordering Reference; Brass (no suffix required); Nickel Plated Brass '5'; 316 Grade Stainless Steel '4'; Copper Free Aluminium '1'
 For NPT options add the following digits to the material suffix; 1/2" = 31; 3/4" = 32; 1" = 33; 1 1/4" = 34; 1 1/2" = 35; 2" = 36; 2 1/2" = 37; 3" = 38; 3 1/2" = 39; 4" = 310 (Brass requires prefix '0')

Examples: 32CWC1RA534 = Nickel Plated Brass 1 1/4" NPT, 50SCWC1RA035 = Brass 1 1/2" NPT, 25CWC1RA432 = Stainless Steel 3/4" NPT, 20CWC1RA5 = Nickel Plated Brass M20

Dimensions are displayed in millimetres unless otherwise stated

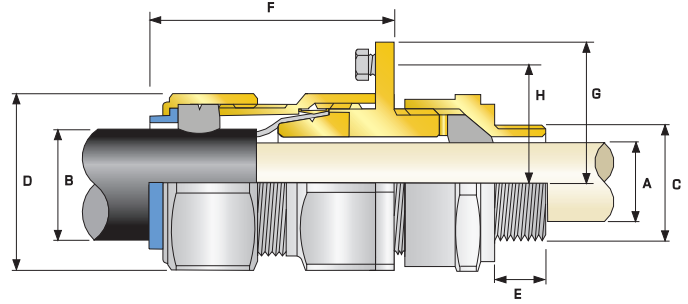

E1W CIEL

E1W Double Seal Industrial Cast Integral Earth Lug Cable Gland

For all types of Steel & Aluminium Wire Armoured Cables

- External earth connection
- Third party short circuit tested
- Metal-to-metal armour clamping
- Direct & remote installation
- Permanently crimped, low impedance earth termination
- Secure against self-loosening
- Displacement type inner seal
- Controlled outer 'load retention' seal
- Unique OSTG prevents overtightening
- Deluge protection option
- -60°C to +130°C
- Superior EMC performance



The Symmetrical Fault Current (kA) rating for 1 second applicable to the Cast Integral Earth Lug featured in the E1W CIEL products are as follows:
 26.0 kA for Cable Gland sizes up to 40
 43.0 kA for Cable Gland sizes 50S and above.

TECHNICAL DATA

Design Specification	BS 6121:Part 1:1989, IEC 62444, EN 62444
Mechanical Classifications*	Impact = Level 8, Cable Anchorage = Class D
Enclosure Protection	IK10 to IEC 62262 (20 joules) Brass & Stainless Steel only
Electrical Classifications*	Category C
Marine Approvals	LRS: 01/00171 (E1), ABS: 16-LD1472056-PDA
GOST R Certificate	POCC GB.AF35.H00102
Ingress Protection Rating**	IP66 as standard (IP67, IP68*** available upon request)
Cable Gland Material	Brass, Electroless Nickel Plated Brass, Aluminium
Seal Material	CMP Thermoset Rubber
Cable Type	Single Wire Armour (SWA), Aluminium Wire Armour (AWA)
Armour Clamping	Detachable Armour Cone & AnyWay Universal Clamping Ring
Sealing Technique	CMP Inner Displacement Seal & Unique CMP 'LRS'™ Outer Load Retention Seal
Sealing Area(s)	Cable Inner Bedding & Outer Cable Sheath

* Mechanical & Electrical Classifications applied as per IEC 62444 & EN 62444

** When CMP installation accessories are used. Refer to page 7 or www.cmp-products.com for further information.

*** IP68 tested to a minimum depth of 30 metres for 12 hours, alternate depths / durations can be provided upon request

Cable Gland Selection Table

Refer to illustration at the top of the page.

Dimensions listed below are for metric cable glands only

Dimensions for alternative threads may vary, please see supplementary technical data sheet

Cable Gland Size	Available Entry Threads "C" (Alternate Metric Thread Lengths Available)				Cable Bedding Diameter "A"		Overall Cable Diameter "B"		Armour Range		Across Flats "D"	Across Corners "D"	Protrusion Length "F"	Radius Dimension		CIEL Earth Bolt Size	Earth Fault Current Rating (kA)	Combined Ordering Reference (*Brass Metric)			Cable Gland Weight (Kgs)	
	Metric	Standard		Option		Min	Max	Min	Max	Min	Max	Min		Max	"H"			"G"	Size	Type		Ordering Suffix
		Thread Length (Metric) "E"	NPT	Thread Length (NPT) "E"	NPT																	
20S	M20	10.0	1/2"	19.9	3/4"	6.1	11.6	9.5	15.9	0.8	1.25	24.0	26.4	70.0	28.6	38.6	M8	26.0	20S	E1WC	1RA	0.195
20	M20	10.0	1/2"	19.9	3/4"	6.5	13.9	12.5	20.9	0.8	1.25	30.5	33.6	73.0	31.8	41.8	M8	26.0	20	E1WC	1RA	0.276
25S	M25	10.0	3/4"	20.2	1"	11.1	19.9	14.0	22.0	1.25	1.6	37.5	41.3	89.0	38.1	50.8	M8	26.0	25S	E1WC	1RA	0.438
25	M25	10.0	3/4"	20.2	1"	11.1	19.9	18.2	26.2	1.25	1.6	37.5	41.3	89.0	38.1	50.8	M8	26.0	25	E1WC	1RA	0.435
32	M32	10.0	1"	25.0	1 1/4"	17.0	26.2	23.7	33.9	1.6	2.0	46.0	50.6	86.0	41.3	54.0	M10	26.0	32	E1WC	1RA	0.506
40	M40	15.0	1 1/4"	25.6	1 1/2"	22.0	32.1	27.9	40.4	1.6	2.0	55.0	60.5	90.0	50.8	68.3	M12	26.0	40	E1WC	1RA	0.802
50S	M50	15.0	1 1/2"	26.1	2"	29.5	38.1	35.2	46.7	2.0	2.5	60.0	66.0	91.0	57.2	74.6	M12	43.0	50S	E1WC	1RA	0.883
50	M50	15.0	2"	26.9	2 1/2"	35.6	44.0	40.4	53.0	2.0	2.5	70.1	77.1	95.0	60.3	79.4	M12	43.0	50	E1WC	1RA	1.038
63S	M63	15.0	2"	26.9	2 1/2"	40.1	49.9	45.6	59.4	2.0	2.5	75.0	82.5	102.0	70.0	90.5	M12	43.0	63S	E1WC	1RA	1.636
63	M63	15.0	2 1/2"	39.9	3"	47.2	55.9	54.6	65.8	2.0	2.5	80.0	88.0	104.0	70.0	90.5	M12	43.0	63	E1WC	1RA	1.597
75S	M75	15.0	2 1/2"	39.9	3"	52.8	61.9	59.0	72.0	2.0	2.5	90.0	99.0	115.0	76.2	98.5	M12	43.0	75S	E1WC	1RA	2.310
75	M75	15.0	3"	41.5	3 1/2"	59.1	67.9	66.7	78.4	2.5	3.0	100.0	110.0	117.0	82.6	108.0	M12	43.0	75	E1WC	1RA	2.717
90	M90	24.0	3 1/2"	42.8	4"	66.6	78.6	76.2	90.3	3.15	4.0	114.3	125.7	147.0	95.3	127.1	M12	43.0	90	E1WC	1RA	4.417
100	M100	24.0	4"	44.0	5"	76.0	90.9	86.1	101.4	3.15	4.0	123.0	135.3	140.0	102.0	133.8	M12	43.0	100	E1WC	1RA	4.820
115	M115	24.0	4"	44.0	5"	86.0	97.9	101.5	110.2	3.15	4.0	133.4	146.7	162.0	95.3	127.1	M12	43.0	115	E1WC	1RA	6.191
130	M130	24.0	5"	46.8	6"	97.0	114.9	110.2	123.2	3.15	4.0	152.4	167.6	177.0	102.0	133.8	M12	43.0	130	E1WC	1RA	8.539

*Note: For material options please add the following suffix to change the Ordering Reference; Brass (no suffix required), Nickel Plated Brass "5", Copper Free Aluminium "1"
 For NPT options add the following digits to the material suffix; 1/2" = 31; 3/4" = 32; 1" = 33; 1 1/4" = 34; 1 1/2" = 35; 2" = 36; 2 1/2" = 37; 3" = 38; 3 1/2" = 39; 4" = 310 (Brass requires prefix '0')

Examples: 32E1WC1RA534 = Nickel Plated Brass 1 1/4" NPT, 50SE1WC1RA035 = Brass 1 1/2" NPT, 20E1WC1RA5 = Nickel Plated Brass M20

Dimensions are displayed in millimetres unless otherwise stated

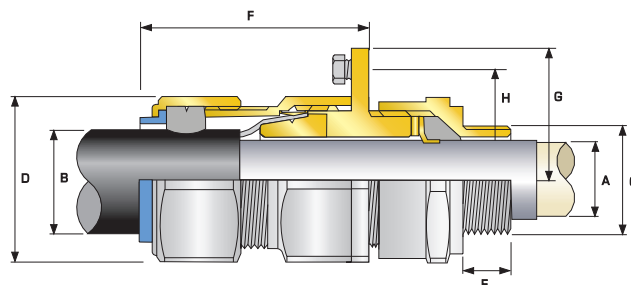
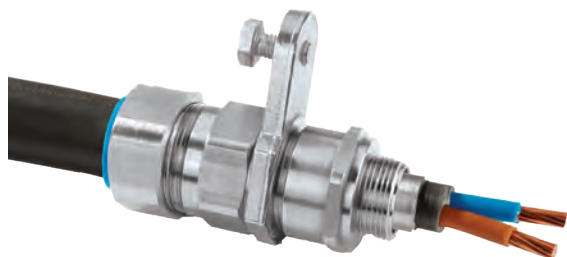

E2W CIEL

E2W Industrial Double Seal Cast Integral Earth Lug Cable Gland

For all types of Steel & Aluminium Wire Lead Sheathed Armoured Cables

- External & Internal Earth Connection
- Third party short circuit tested
- Metal-to-metal armour clamping
- Direct & remote installation
- Permanently crimped, low impedance earth termination
- Secure against self-loosening
- Displacement type inner seal
- Controlled outer 'load retention' seal
- Unique OSTG prevents overtightening
- Deluge protection option
- -60°C to +130°C
- Superior EMC performance



The Symmetrical Fault Current (kA) rating for 1 second applicable to the Cast Integral Earth Lug featured in the E2W CIEL products are as follows:
 26.0 kA for Cable Gland sizes up to 40
 43.0 kA for Cable Gland sizes 50S and above.

TECHNICAL DATA	
Design Specification	BS 6121:Part 1:1989, IEC 62444, EN 62444
Mechanical Classifications*	Impact = Level 8, Cable Anchorage = Class D
Enclosure Protection	IK10 to IEC 62262 (20 joules) Brass & Stainless Steel only
Electrical Classifications*	Category C
Marine Approvals	LRS: 01/00171 (E1), ABS: 16-LD1472056-PDA
GOST R Certificate	POCC GB.AГ35.H00102
Ingress Protection Rating**	IP66 as standard (IP67, IP68*** available upon request)
Cable Gland Material	Brass, Electroless Nickel Plated Brass, Aluminium
Seal Material	CMP Thermoset Rubber
Cable Type	Lead Sheathed & Single Wire Armour (LC/SWA), Lead Sheathed Aluminium Wire Armour (LC/AWA)
Armour Clamping	Detachable Armour Cone & AnyWay Universal Clamping Ring
Sealing Technique	CMP Inner Displacement Seal & Unique CMP 'LRS'™ Outer Load Retention Seal
Sealing Area(s)	Cable Inner Bedding & Outer Cable Sheath

* Mechanical & Electrical Classifications applied as per IEC 62444 & EN 62444
 ** When CMP installation accessories are used. Refer to page 7 or www.cmp-products.com for further information.
 *** IP68 tested to a minimum depth of 30 metres for 12 hours, alternate depths / durations can be provided upon request

Cable Gland Selection Table

Refer to illustration at the top of the page.

Dimensions listed below are for metric cable glands only
 Dimensions for alternative threads may vary, please see supplementary technical data sheet

Cable Gland Size	Available Entry Threads "C" (Alternate Metric Thread Lengths Available)					Lead Sheath Diameter "A"		Overall Cable Diameter "B"		Armour Range		Across Flats "D"	Across Corners "D"	Protrusion Length "F"	Radius Dimension		CIE Earth Bolt Size	Earth Fault Current Rating (kA)	Combined Ordering Reference (*Brass Metric)			Cable Gland Weight (Kgs)
	Standard			Option		Min	Max	Min	Max	Min	Max	Max	Max		"H"	"G"			Size	Type	Ordering Suffix	
	Metric	Thread Length (Metric) "E"	NPT	Thread Length (NPT) "E"	NPT																	
20S	M20	10.0	½"	19.9	¾"	6.1	11.0	9.5	15.9	0.8	1.25	24.0	26.4	70.0	28.6	38.6	M8	26	20S	E2WC	1RA	0.195
20	M20	10.0	½"	19.9	¾"	6.5	13.4	12.5	20.9	0.8	1.25	30.5	33.6	73.0	31.8	41.8	M8	26	20	E2WC	1RA	0.276
25S	M25	10.0	¾"	20.2	1"	11.1	19.3	14.0	22.0	1.25	1.6	37.5	41.3	89.0	38.1	50.8	M8	26	25S	E2WC	1RA	0.438
25	M25	10.0	¾"	20.2	1"	11.1	19.3	18.2	26.2	1.25	1.6	37.5	41.3	89.0	38.1	50.8	M8	26	25	E2WC	1RA	0.435
32	M32	10.0	1"	25.0	1 ¼"	17.0	25.5	23.7	33.9	1.6	2.0	46.0	50.6	86.0	41.3	54.0	M8	26	32	E2WC	1RA	0.506
40	M40	15.0	1 ¼"	25.6	1 ½"	22.0	31.2	27.9	40.4	1.6	2.0	55.0	60.5	90.0	50.8	68.3	M10	26	40	E2WC	1RA	0.802
50S	M50	15.0	1 ½"	26.1	2"	29.5	37.2	35.2	46.7	2.0	2.5	60.0	66.0	91.0	57.2	74.6	M12	43	50S	E2WC	1RA	0.883
50	M50	15.0	2"	26.9	2 ½"	35.6	42.6	40.4	53.0	2.0	2.5	70.1	77.1	95.0	60.3	79.4	M12	43	50	E2WC	1RA	1.038
63S	M63	15.0	2"	26.9	2 ½"	40.1	48.5	45.6	59.4	2.0	2.5	75.0	82.5	102.0	70.0	90.5	M12	43	63S	E2WC	1RA	1.636
63	M63	15.0	2 ½"	39.9	3"	47.2	54.2	54.6	65.8	2.0	2.5	80.0	88.0	104.0	70.0	90.5	M12	43	63	E2WC	1RA	1.597
75S	M75	15.0	2 ½"	39.9	3"	52.8	60.2	59.0	72.0	2.0	2.5	90.0	99.0	115.0	76.2	98.5	M12	43	75S	E2WC	1RA	2.310
75	M75	15.0	3"	41.5	3 ½"	59.1	65.2	66.7	78.4	2.5	3.0	100.0	110.0	117.0	82.6	108.0	M12	43	75	E2WC	1RA	2.717
90	M90	24.0	3"	42.8	4"	66.6	77.1	76.2	90.3	3.15	4.0	114.3	125.7	147.0	95.3	127.1	M12	43	90	E2WC	1RA	4.417
100	M100	24.0	4"	44.0	5"	76.0	88.1	86.1	101.4	3.15	4.0	123.0	135.3	140.0	102.0	133.8	M12	43	100	E2WC	1RA	4.820
115	M115	24.0	4"	44.0	5"	86.0	94.1	101.5	110.2	3.15	4.0	133.4	146.7	162.0	95.3	127.1	M12	43	115	E2WC	1RA	6.191
130	M130	24.0	5"	46.8	6"	97.0	110.1	110.2	123.2	3.15	4.0	152.4	167.6	177.0	102.0	133.8	M12	43	130	E2WC	1RA	8.539

*Note : For material options please add the following suffix to change the Ordering Reference : Brass (no suffix required), Nickel Plated Brass "5", Copper Free Aluminium "1"
 For NPT options add the following digits to the material suffix; ½" = 31; ¾" = 32; 1" = 33; 1 ¼" = 34; 1 ½" = 35; 2" = 36; 2 ½" = 37; 3" = 38; 3 ½" = 39; 4" = 310 (Brass requires prefix '0')

Examples: 32E2WC1RA534 = Nickel Plated Brass 1 ¼" NPT, 50SE2WC1RA035 = Brass 1 ½" NPT, 20E2WC1RA5 = Nickel Plated Brass M20

Dimensions are displayed in millimetres unless otherwise stated



ZEN Insulated Cable Glands

The CMP ZEN Range of Insulated Cable Glands enables an innovative approach for electrical cable installations. Providing a method which permits the zoning of earth connections for earthed neutral system of supply. CMP ZEN Cable Glands provide flexibility in the design of the earthing circuit and means of testing earth circuits without disconnecting the Cable Gland.

Circulating currents can be eliminated and cable noise in instrument cables can be controlled by single point earthing. Insulated components are available in materials tested for use in containment areas of nuclear type pressurised water reactor power stations.

CMP ZEN range of Cable Glands are available to suit cables with steel and aluminium wire armour, aluminium strip armour and steel tape armour.

Designed in accordance with BS6121, IEC 62444 and EN 62444. Specified extensively in the UK Power Stations and tested to GDCD190 specification.

Other cable gland solutions specifically designed for terminating screened variable speed drive (VSD) and EMC cables are available with and without an insulated connection. Please contact CMP for further details if required.



ZEN

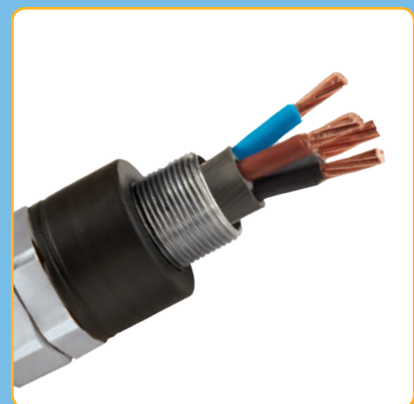

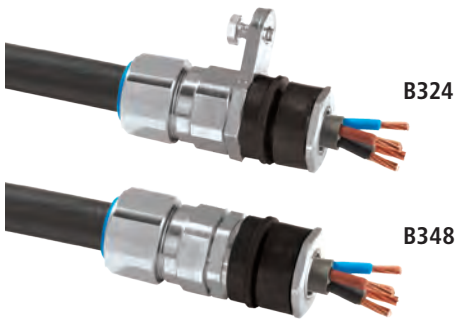

B324 B348 ZEN

Insulated Industrial Cable Gland

For all types of Steel & Aluminium Wire Armoured Cables

- High quality durable materials
- Robust, heavy duty insulated design
- Metal-to-metal armour clamping
- Permanently crimped, low impedance earth termination
- Secure against self-loosening
- Direct & remote installation
- Enables zoning of earthed neutral systems
- Eliminates circulating currents
- High capacity external earth connection (B324)
- Third party short circuit tested
- Controlled outer 'load retention' seal
- Unique OSTG prevents overtightening
- -60°C to +130°C
- Superior EMC performance



Earth Tags can only be fitted to the B348 & A348 ZEN Cable Gland types.

The Symmetrical Fault Current (kA) rating for 1 second applicable to the Cast Integral Earth Lug featured in the B324 and A324 products are as follows:
26.0 kA for Cable Gland sizes up to 40
43.0 kA for Cable Gland sizes 50S and above

Please refer to the CMP CW CIEL product page for dimensional details of the Cast Integral Earth Lug feature included in the B324 and A324 designs.
Aluminium version available for AWA cables. When ordering please substitute letter B in B324 & B348 with letter A.

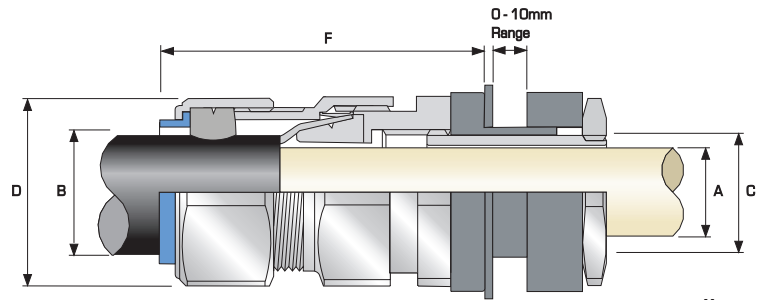

B348 Illustrated

TECHNICAL DATA

Type	B324 / B348
Design Specification	BS 6121:Part 1:1989, GDCD 190, IEC 62444, EN 62444
Mechanical Classifications*	Impact = Level 8, Cable Anchorage = Class D
Enclosure Protection	IK10 to IEC 62262 (20 joules) Brass & Stainless Steel only
Electrical Classifications*	Category B (B348) & Category C (B324)
GOST R Certificate	POCC GB.AF35.H00102
Ingress Protection Rating**	IP66
Standard Cable Gland Material	Brass
Alternative Cable Gland Material	Nickel Plated Brass, Aluminium, Stainless Steel
Seal Material	CMP Thermoset Rubber
Cable Type	Single Wire Armour (SWA), Aluminium Wire Armour (AWA)
Armour Clamping	Three Part Armour Lock With AnyWay Universal Clamping Ring
Sealing Technique	Unique CMP 'LRS' Outer Seal (Load Retention Seal)
Sealing Area(s)	Cable Outer Sheath

* Mechanical & Electrical Classifications applied as per IEC 62444 & EN 62444

** When CMP installation accessories are used. Refer to page 7 or www.cmp-products.com for further information.

Cable Gland Selection Table

Refer to illustration at the top of the page.

Cable Gland Size	Clearance Hole Diameter "C"	Cable Bedding Diameter "A"	Overall Cable Diameter "B"		Armour Range		Across Flats "D"	Across Corners "D"	Protrusion Length "F"	Ordering Reference (Brass Metric)		Shroud (B348)	Cable Gland Weight (Kgs)
			Max	Min	Min	Max				Max	Max		
20S	20.6	11.6	9.5	15.9	0.8	1.25	24.0	26.4	58.6	20SB3241RA	20SB3481RA	PVC04	0.160
20	20.6	13.9	12.5	20.9	0.8	1.25	30.5	33.6	59.9	20B3241RA	20B3481RA	PVC06	0.220
25S	25.6	19.9	14.0	22.0	1.25	1.6	37.5	41.3	69.1	25SB3241RA	25SB3481RA	PVC09	0.340
25	25.6	19.9	18.2	26.2	1.25	1.6	37.5	41.3	69.1	25B3241RA	25B3481RA	PVC09	0.340
32	32.6	26.2	23.7	33.9	1.6	2.0	46.0	50.6	67.6	32B3241RA	32B3481RA	PVC11	0.440
40	40.6	32.1	27.9	40.4	1.6	2.0	55.0	60.5	73.1	40B3241RA	40B3481RA	PVC15	0.710
50S	50.7	38.1	35.2	46.7	2.0	2.5	60.0	66.0	72.1	50SB3241RA	50SB3481RA	PVC18	0.820
50	50.7	44.0	40.4	53.0	2.0	2.5	70.1	77.1	74.2	50B3241RA	50B3481RA	PVC21	1.060
63S	63.7	49.9	45.6	59.4	2.0	2.5	75.0	82.5	86.2	63SB3241RA	63SB3481RA	PVC23	1.510
63	63.7	55.9	54.6	65.8	2.0	2.5	80.0	88.0	86.1	63B3241RA	63B3481RA	PVC25	1.530
75S	75.7	61.9	59.0	72.0	2.0	2.5	90.0	99.0	96.5	75SB3241RA	75SB3481RA	PVC28	2.100
75	75.7	67.9	66.7	78.4	2.5	3.0	100.0	110.0	95.3	75B3241RA	75B3481RA	PVC30	2.620
90	90.8	79.4	76.2	90.3	3.15	4.0	115.0	126.5	107.6	90B3241RA	90B3481RA	PVC32	3.740

Dimensions are displayed in millimetres unless otherwise stated

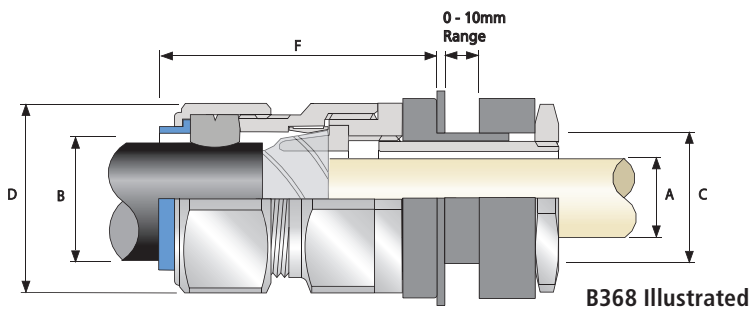
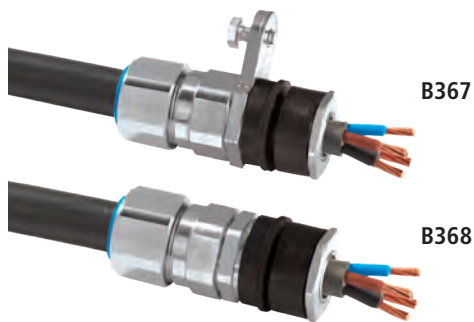

B367 B368 ZEN

Insulated Industrial Cable Gland

For all types of Braided & Tape Armoured Cables

- Metal-to-metal armour clamping
- Permanently crimped, low impedance earth termination
- Secure against self-loosening
- Direct & remote installation
- Enables zoning of earthed neutral systems
- Eliminates circulating currents
- High capacity external earth connection (B367)
- Third party short circuit tested
- Controlled outer 'load retention' seal
- Unique OSTG prevents overtightening
- -60°C to +130°C
- Superior EMC performance

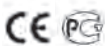

† Grooved Cone (X) is predominantly used for Wire Braid (e.g. GSWB, TCWB), Steel Tape Armour (STA, DSTA) and Aluminium Strip Armour (ASA) but is also suitable for Single Wire Armour (SWA), Aluminium Wire Armour (AWA) and Pliable Wire Armour (PWA) if the range is outside that of the Stepped Cone (W).

Grooved Cone (X) dimensions shown in the Cable Gland Selection Table below are for a double wire strand of braid armour cables. Tapes can also be doubled over. For cables that have only a single layer of armour such as SWA the clamping range should be used as shown in the table below.

Earth Tags can only be fitted to the B368 & A368 ZEN Cable Gland types.

The Symmetrical Fault Current (kA) rating for 1 second applicable to the Cast Integral Earth Lug featured in the B367 and A367 products are as follows:
26.0 kA for Cable Gland sizes up to 40
43.0 kA for Cable Gland sizes 50S and above

Please refer to the CMP CW-CIEL product page for dimensional details of the Cast Integral Earth Lug feature included in the B367 and A367 designs.
Aluminium version available for AWA cables. When ordering please substitute letter B in B324 & B348 with letter A.

TECHNICAL DATA

Type	B367 / B368
Design Specification	BS 6121:Part 1:1989, GDCC 190, IEC 62444, EN 62444
Mechanical Classifications*	Impact = Level 8, Cable Anchorage = Class D
Enclosure Protection	IK10 to IEC 62262 (20 joules) Brass & Stainless Steel only
Electrical Classifications*	Category B (B368) & Category C (B367)
GOST R Certificate	POCC GB.AF35.H00102
Ingress Protection Rating**	IP66
Standard Cable Gland Material	Brass
Alternative Cable Gland Material	Nickel Plated Brass, Aluminium, Stainless Steel
Seal Material	CMP Thermoset Rubber
Cable Type	Wire Braid Armour, Pliable Wire Armour (PWA), Steel Tape Armour (STA)
Armour Clamping	Three Part Armour Lock With AnyWay Universal Clamping Ring
Sealing Technique	Unique CMP 'LRS' Outer Seal (Load Retention Seal)
Sealing Area(s)	Cable Outer Sheath

* Mechanical & Electrical Classifications applied as per IEC 62444 & EN 62444

** When CMP installation accessories are used. Refer to page 7 or www.cmp-products.com for further information.

Cable Gland Selection Table

Refer to illustration at the top of the page.

Cable Gland Size	Clearance Hole Diameter "C"	Cable Bedding Diameter "A" Max	Overall Cable Diameter "B"		Armour Range † Grooved Cone (X)		Across Flats "D"	Across Corners "D"	Protrusion Length "F"	Ordering Reference (Brass Metric)		Shroud (B368)	Cable Gland Weight (Kgs)
			Min	Max	Min	Max				With CIEL Lug (B367)	Without CIEL Lug (B368)		
20S	20.6	11.6	9.5	15.9	0.3	1.0	24.0	26.4	58.6	20SB3671RA	20SB3681RA	PVC04	0.160
20	20.6	13.9	12.5	20.9	0.4	1.0	30.5	33.6	59.9	20B3671RA	20B3681RA	PVC06	0.220
25S	25.6	19.9	14.0	22.0	0.4	1.2	37.5	41.3	69.1	25SB3671RA	25SB3681RA	PVC09	0.340
25	25.6	19.9	18.2	26.2	0.4	1.2	37.5	41.3	69.1	25B3671RA	25B3681RA	PVC09	0.340
32	32.6	26.2	23.7	33.9	0.4	1.2	46.0	50.6	67.6	32B3671RA	32B3681RA	PVC11	0.440
40	40.6	32.1	27.9	40.4	0.4	1.6	55.0	60.5	73.1	40B3671RA	40B3681RA	PVC15	0.710
50S	50.7	38.1	35.2	46.7	0.4	1.6	61.2	66.0	72.1	50SB3671RA	50SB3681RA	PVC18	0.820
50	50.7	44.0	40.4	53.0	0.6	1.6	70.1	77.1	74.2	50B3671RA	50B3681RA	PVC21	1.060
63S	63.7	49.9	45.6	59.4	0.6	1.6	75.0	82.5	86.2	63SB3671RA	63SB3681RA	PVC23	1.510
63	63.7	55.9	54.6	65.8	0.6	1.6	80.0	88.0	86.1	63B3671RA	63B3681RA	PVC25	1.530
75S	75.7	61.9	59.0	72.0	0.6	1.6	90.0	99.0	96.5	75SB3671RA	75SB3681RA	PVC28	2.100
75	75.7	67.9	66.7	78.4	0.6	1.6	100.0	110.0	95.3	75B3671RA	75B3681RA	PVC30	2.620
90	90.8	79.4	76.2	90.3	0.8	1.6	114.3	125.7	107.6	90B3671RA	90B3681RA	PVC32	3.740

Dimensions are displayed in millimetres unless otherwise stated

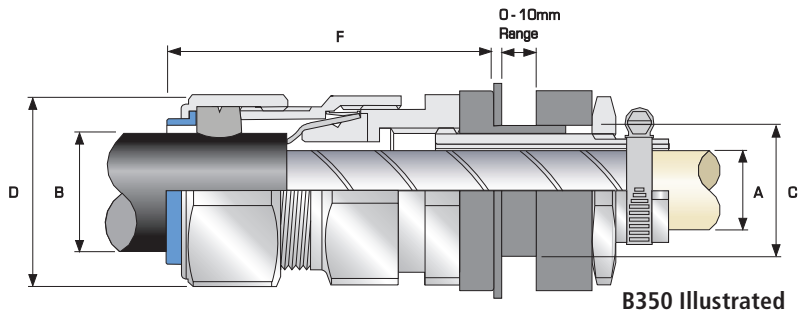

B350 Illustrated

B327 B350 ZEN

Insulated Industrial Cable Gland

For all types of Steel & Aluminium Wire Armoured Cables with a Metallic Tape Screen

- High quality durable materials
- Robust, heavy duty insulated design
- Metal-to-metal armour clamping
- Permanently crimped, low impedance earth termination
- Secure against self-loosening
- Direct & remote installation
- Enables zoning of earthed neutral systems
- Eliminates circulating currents
- High capacity external earth connection (B327)
- Third party short circuit tested
- Controlled outer 'load retention' seal
- Unique OSTG prevents overtightening
- -60°C to +130°C
- Superior EMC performance

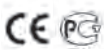

Earth Tags can only be fitted to the B350 & A350 ZEN gland types.

The Symmetrical Fault Current (kA) rating for 1 second applicable to the Cast Integral Earth Lug featured in the B327 and A327 products are as follows:
 26.0 kA for Cable Gland sizes up to 40
 43.0 kA for Cable Gland sizes 50S and above

Please refer to the CMP CW CIEL product page for dimensional details of the Cast Integral Earth Lug feature included in the B327 and A327 designs.

Aluminium version available for AWA cables. When ordering please substitute letter B in B327 & B350 with letter A.

TECHNICAL DATA

Type	B327 / B350
Design Specification	BS 6121:Part 1:1989, GDCD 190, IEC 62444, EN 62444
Mechanical Classifications*	Impact = Level 8, Cable Anchorage = Class D
Enclosure Protection	IK10 to IEC 62262 (20 joules) Brass & Stainless Steel only
Electrical Classifications*	Category B (B350) & Category C (B327)
GOST R Certificate	POCC GB.AT35.H00102
Ingress Protection Rating**	IP66
Cable Gland Material	Brass
Alternative Cable Gland Material	Nickel Plated Brass, Aluminium, Stainless Steel
Seal Material	CMP Thermoset Rubber
Cable Type	Single Wire Armour (SWA), Aluminium Wire Armour (AWA) with Metallic Tape Screen
Armour Clamping	Three Part Armour Lock With AnyWay Universal Clamping Ring
Sealing Technique	Unique CMP 'LRS' Outer Seal (Load Retention Seal)
Sealing Area(s)	Cable Outer Sheath

* Mechanical & Electrical Classifications applied as per IEC 62444 & EN 62444

** When CMP installation accessories are used. Refer to page 7 or www.cmp-products.com for further information.

Cable Gland Selection Table

Refer to illustration at the top of the page.

Cable Gland Size	Clearance Hole Diameter "C"	Cable Bedding Diameter "A"		Overall Cable Diameter "B"			Armour Range		Across Flats "D"	Across Corners "D"	Protrusion Length "F"	Ordering Reference (Brass Metric)		Shroud (B350)	Cable Gland Weight (Kgs)
		Max	Min	Max	Min	Max	Max	Max				With CIEL Lug (B327)	Without CIEL Lug (B350)		
20S	20.6	11.6	9.5	15.9	0.8	1.25	24.0	26.4	58.6	20SB3271RA	20SB3501RA	PVC04	0.160		
20	20.6	13.9	12.5	20.9	0.8	1.25	30.5	33.6	59.9	20B3271RA	20B3501RA	PVC06	0.220		
25S	25.6	19.9	14.0	22.0	1.25	1.6	37.5	41.3	69.1	25SB3271RA	25SB3501RA	PVC09	0.340		
25	25.6	19.9	18.2	26.2	1.25	1.6	37.5	41.3	69.1	25B3271RA	25B3501RA	PVC09	0.340		
32	32.6	26.2	23.7	33.9	1.6	2.0	46.0	50.6	67.6	32B3271RA	32B3501RA	PVC11	0.440		
40	40.6	32.1	27.9	40.4	1.6	2.0	55.0	60.5	73.1	40B3271RA	40SB3501RA	PVC15	0.710		
50S	50.7	38.1	35.2	46.7	2.0	2.5	60.0	66.0	72.1	50SB3271RA	50SB3501RA	PVC18	0.820		
50	50.7	44.0	40.4	53.0	2.0	2.5	70.1	77.1	74.2	50B3271RA	50B3501RA	PVC21	1.060		
63S	63.7	49.9	45.6	59.4	2.0	2.5	75.0	82.5	86.2	63SB3271RA	63SB3501RA	PVC23	1.510		
63	63.7	55.9	54.6	65.8	2.0	2.5	80.0	88.0	86.1	63B3271RA	63B3501RA	PVC25	1.530		
75S	75.7	61.9	59.0	72.0	2.0	2.5	90.0	99.0	96.5	75SB3271RA	75SB3501RA	PVC28	2.100		
75	75.7	67.9	66.7	78.4	2.5	3.0	100.0	110.0	95.3	75B3271RA	75B3501RA	PVC30	2.620		
90	90.8	79.4	76.2	90.3	3.15	4.0	115.0	126.5	107.6	90B3271RA	90B3501RA	PVC32	3.740		

Dimensions are displayed in millimetres unless otherwise stated

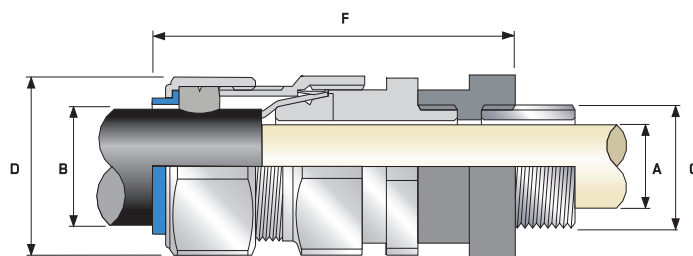

B347 Illustrated

B323 B347 ZEN

Insulated Industrial Cable Gland

For all types of Steel & Aluminium Wire Armoured Cables

- High quality durable materials
- Robust, heavy duty insulated design
- Metal-to-metal armour clamping
- Permanently crimped, low impedance earth termination
- Secure against self-loosening
- Direct & remote installation
- Enables zoning of earthed neutral systems
- Eliminates circulating currents
- High capacity external earth connection (B347)
- Third party short circuit tested
- Controlled outer 'load retention' seal
- Unique OSTG prevents overtightening
- -60°C to +130°C
- Superior EMC performance

TECHNICAL DATA	
Type	B323 / B347
Design Specification	BS 6121:Part 1:1989, GDCD 190, IEC 62444, EN 62444
Mechanical Classifications*	Impact = Level 8, Cable Anchorage = Class D
Enclosure Protection	IK10 to IEC 62262 (20 joules) Brass & Stainless Steel only
Electrical Classifications*	Category B (B323) & Category C (B347)
GOST R Certificate	POCC GB.AГ35.H00102
Ingress Protection Rating**	IP66
Cable Gland Material	Brass
Alternative Cable Gland Material	Nickel Plated Brass, Aluminium, Stainless Steel
Seal Material	CMP Thermoset Rubber
Cable Type	Single Wire Armour (SWA), Aluminium Wire Armour (AWA)
Armour Clamping	Three Part Armour Lock With AnyWay Universal Clamping Ring
Sealing Technique	Unique CMP 'LRS'™ Outer Seal (Load Retention Seal)
Sealing Area(s)	Cable Outer Sheath

* Mechanical & Electrical Classifications applied as per IEC 62444 & EN 62444
 ** When CMP installation accessories are used. Refer to page 7 or www.cmp-products.com for further information.



Earth Tags can only be fitted to the B323 & A323 ZEN gland types.

The Symmetrical Fault Current (kA) rating for 1 second applicable to the Cast Integral Earth Lug featured in the B347 and A347 products are as follows:
 26.0 kA for Cable Gland sizes up to 40
 43.0 kA for Cable Gland sizes 50S and above

Please refer to the CMP CW CIEL product page for dimensional details of the Cast Integral Earth Lug feature included in the B347 and A347 designs.

Aluminium version available for AWA cables. When ordering please substitute letter B in B323 & B347 with letter A.

Cable Gland Selection Table

Refer to illustration at the top of the page.

Cable Gland Size	Entry Thread "C"	Cable Bedding Diameter "A"	Overall Cable Diameter "B"		Armour Range		Across Flats "D"	Across Corners "D"	Protrusion Length "F"	Ordering Reference (Brass Metric)		Shroud (B323)	Cable Gland Weight (Kgs)
			Max	Min	Min	Max				Without CIEL Lug (B323)	With CIEL Lug (B347)		
20S	M20	11.6	9.5	15.9	0.8	1.25	24.0	26.4	73.6	20SB3231RA	20SB3471RA	PVC04	0.190
20	M20	13.9	12.5	20.9	0.8	1.25	30.5	33.6	74.9	20B3231RA	20B3471RA	PVC06	0.240
25S	M25	19.9	14.0	22.0	1.25	1.6	37.5	41.3	84.1	25SB3231RA	25SB3471RA	PVC09	0.350
25	M25	19.9	18.2	26.2	1.25	1.6	37.5	41.3	84.1	25B3231RA	25B3471RA	PVC09	0.350
32	M32	26.2	23.7	33.9	1.6	2.0	46.0	50.6	82.5	32B3231RA	32B3471RA	PVC11	0.470

Dimensions are displayed in millimetres unless otherwise stated



CMP EXPLOSIVE ATMOSPHERES PRODUCTS





Explosive Atmosphere Cable Glands

CMP Products offers Explosive Atmosphere Cable Glands that are tested and certified to the latest international technical standards and through its programme of continuous product development always strives to maintain its certification in line with the very latest technical knowledge or state of the art, bringing global products to a world that can expect only the best from CMP in terms of compliance with up to date specifications and standards.

CMP offer certified Cable Gland options for all types of cable, with Ex d, Ex e, Ex nR and Ex ta forms of protection.

Global certification including ATEX, IECEx, EAC, cCSAus, and UL enables the possibility of selecting fewer standard products for multiple situations.

Some solutions in the standard CMP Explosive Atmosphere range offer Bi-code approvals allowing their deployment under both IEC, NEC & CEC installation codes of practice.

All Cable Glands shown in Nickel Plated Brass, alternative materials are available.



Triton CDS - Right First Time Installation

TRITON CDS

Triton T3CDS cable glands deliver a unique concept in cable sealing techniques incorporating the patented Compensating Displacement Seal system, CDS™.

Introduced to effectively handle all types and sizes of cable construction taking away the concern of the operator, letting the product do the job instead.

This concept provides effective sealing on the cable inner sheath, utilising a proven reliable and robust flameproof sealing device. The Compensating Displacement Seal (CDS) System has helped CMP to take its original displacement sealing ring concept to another level. The unique Compensator has allowed the cable gland components to be fully tightened metal-to-metal and relieve the potential excess forces that could be transferred to the cable bedding, eliminating cable damage.

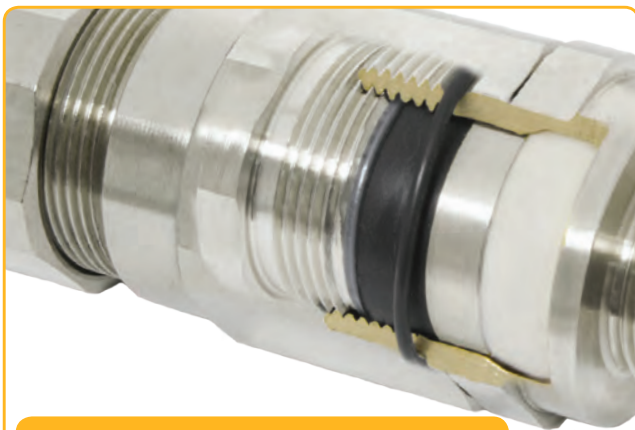

T3CDS Flameproof Sealing System

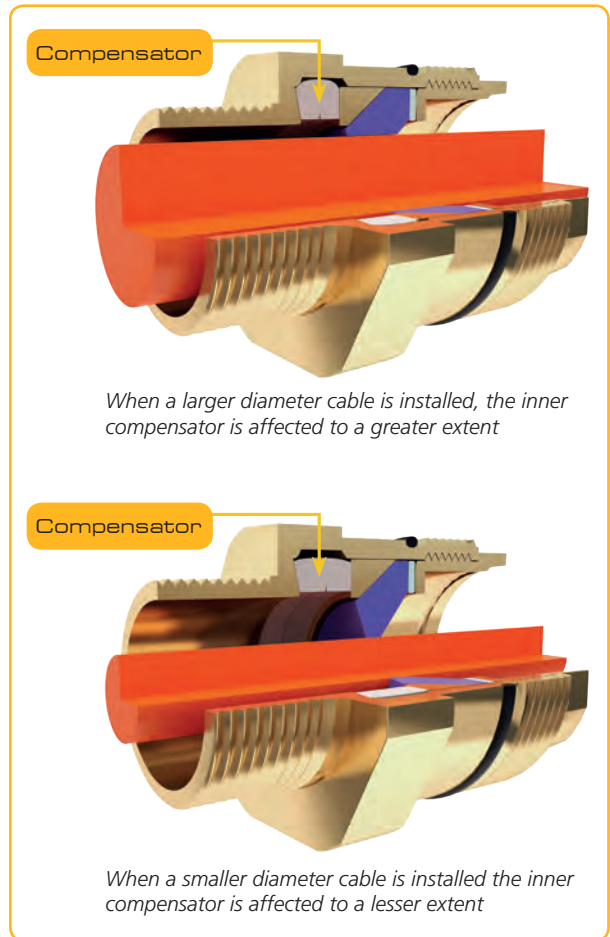

CDS System Inner Flameproof Seal

- Unique Compensating Displacement Seal (CDS) system, compatible with all types of cable
- At the critical cable sealing point the CDS system protects the cable inner sheath from any excess force, which is transferred to and absorbed by the internal compensator incorporated in the CDS system
- Allows the Cable Gland to be tightened metal-to-metal every time regardless of cable diameter



Practical Installation Benefits

- Fully sequential, three step make off procedure
- Quick and easy assembly process, with metal-to-metal installation every time
- CMP make no exaggerated claims concerning its speed of installation but guarantee a “Right First Time” installation well within the highest expectations prescribed
- This “Right First Time” Installation concept, helps to reduce “down time” during plant construction whilst instilling peace of mind in the user
- EMC Noise Reduction levels for radiation emissions comply with the current European guidelines (providing in the region of 50db attenuation when terminated with screened cable)
- Complies with Low Voltage Directive 73/23/EEC
- Uniform hexagon profile

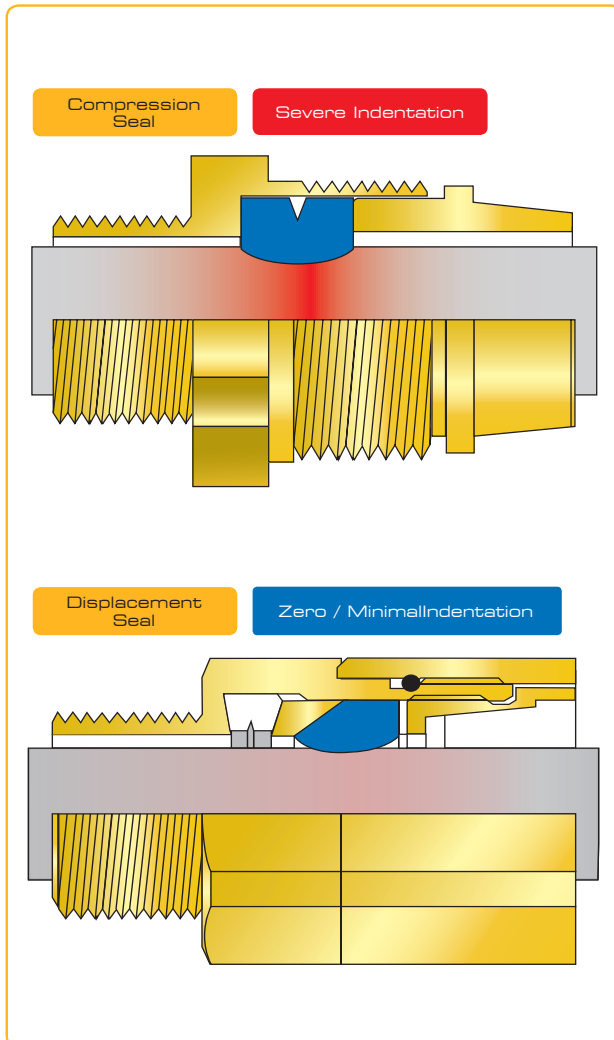
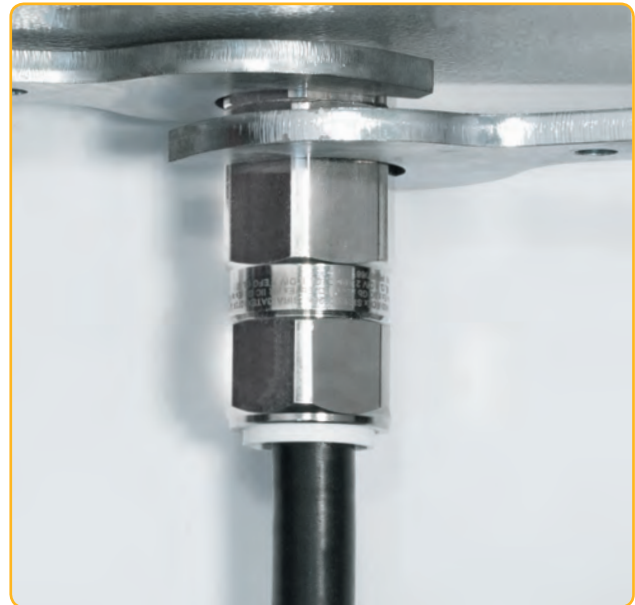

Deluge Protection Seal

- Deluge Protection by means of tried & tested “O” ring feature – Simple and effective arrangement.
- Internal Deluge seal is not exposed to mechanical damage or ultra violet radiation after installation and is completely protected in its operational working life, Latest design limits the potential for over tightening.
- There is no need to “Pull” or re-position the deluge seal on installation or subsequent re-assembly after inspection, as the CMP “O” Ring arrangement engages automatically during a simple installation procedure providing effective protection every time.
- Third Party tested to Shell DTS:01

Additional Options

- Version for effective termination of lead sheathed cables, designated type (T3CDS/PB)
- T3CDSVAR version available for variable speed drive cables with a copper tape screen
- Integral Entry Thread Seal, which removes the need for separate sealing washers. Designation type RT3CDS or RT3CDS/PB



TRITON
CDS

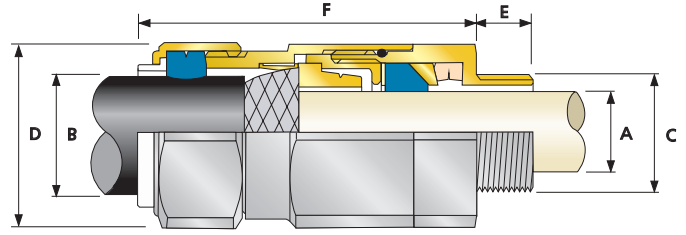

CMP EXPLOSIVE ATMOSPHERES PRODUCTS

T3CDS

Ex e Ex d Ex nR Ex ta

Triton CDS (T3CDS) Globally Approved, Explosive Atmosphere Cable Gland

For all types of Armoured Cables

- Fully sequential, three step installation procedure
- Reduces installation times, cost & risk
- Direct & remote installation
- Unique compensating displacement seal system (CDS)
 - Metal-to-metal installation every time regardless of cable diameter
- Designed to reduce the effects of Coldflow
- Integral protected deluge seal
- Controlled outer 'load retention' seal
- Unique OSTG prevents overtightening
- 60°C to +130°C (standard), -20°C to 200°C (ThermEx option)
- Globally marked, IECEx, ATEX, UL & cCSAus
- Superior EMC performance



† Grooved Cone (X) is predominantly used for Wire Braid (e.g. GSWB, TCWB), Steel Tape Armour (STA, DSTA) and Aluminium Strip Armour (ASA) but is also suitable for Single Wire Armour (SWA), Aluminium Wire Armour (AWA) and Pliable Wire Armour (PWA) if the range is outside that of the Stepped Cone (W).

Grooved Cone (X) dimensions shown in the Cable Gland Selection Table below are for a double wire strand of braid armour cables. Tapes can also be doubled over. For cables that have only a single layer of armour such as SWA the clamping range should be used as shown in the table below.

Stepped (W) Cone is suitable for Single Wire Armour (SWA), or Aluminium Wire Armour (AWA) cables.

TECHNICAL DATA	
Design Specification	BS 6121:Part 1:1989, IEC 62444, EN 62444
Mechanical Classification*	Impact = Level 8, Cable Anchorage = Class D
Enclosure Protection	IK10 to IEC 62262 (20 joules) Brass & Stainless Steel only
Electrical Classification*	Category B (Category A when used with braid, tape or pliable wire armour cables)
ATEX Certificate	SIRA13ATEX1073X, SIRA13ATEX4079X
Code of Protection	II 2G, II 1D, Ex d IIC Gb, Ex e IIC Gb, Ex ta IIIC Da, II 3G Ex nR IIC Gc, I M2, Ex d I Mb, Ex e I Mb
Compliance Standards	EN60079-0,1,7,15,31
IECEx Certificate	IECEx SIR 13.0028X, IECEx SIM 14.0007X
Code of Protection	Ex d IIC Gb, Ex e IIC Gb, Ex nR IIC Gc, Ex ta IIIC Da, Ex d I Mb, Ex e I Mb
Compliance Standards	IEC 60079-0,1,7,15,31
cCSAus Certificate (20S16 - 90)	1310517
CSAus Code of Protection	Class I, Div 2, Groups A,B,C and D, Class II, Div 2, Groups E,F and G, Class III, Enclosure Type 3, 4 and 4X, Class I, Zone 1, AEx e II, AEx nR II
cCSA Code of Protection	Class I, Div 2, Groups A,B,C and D, Class II, Div 2, Groups E,F and G, Class III, Enclosure Type 3, 4 and 4X, Ex d IIC, Ex e IIC, Ex nR II
Compliance Standards	CAN/CSA-C22.2 No 0, 18, 25, 30, 94, 174, CAN/CSA-E60079-0, 1, 7, ANSI/UL 514B Ed 5, ANSI/UL 50 Ed 11, ANSI/UL 2225 Ed 4, UL60079-0, 1, 7
UL Certificate (20S16 - 90)	E200163
Code of Protection	Class I, Zone 1, AEx e II
Compliance Standards	UL514B
EAC Certificate	TC RU C-Gb.ГБ05.В00138
UkrSEPRO	UA.TR.047.C.0644-15
NEPSI Certificate	GYJ13.1141X / GYJ13.1283X
CCOE / PESO (India) Certificate	P333688
INMETRO Certificate	TUV 11.0374X
RETIE Certificate	03866
Marine Certificates	LRS: 01/00172 (E3), DNV: E-13848, ABS: 14-LD234401A-4-PDA, BV: 43180/A1
Ingress Protection Rating**	IP66, IP67 & IP68***
Deluge Protection Compliance	DTS01 : 91
Cable Gland Material	Brass, Electroless Nickel Plated Brass, Aluminium, Stainless Steel
Seal Material	CMP SOLO LSF Halogen Free Thermoset Elastomer
Cable Type(s)	Single Wire Armour (SWA), Aluminium Wire Armour (AWA), Pliable Wire Armour (PWA), Steel Tape Armour (STA), Aluminium Strip Armour (ASA), Screened Flexible (EMC) Wire Braid (e.g CY/SY), Wire Braid Armour (e.g SWB)
Armour Clamping	Reversible Armour Cone & AnyWay Universal Clamping Ring
Sealing Technique	Inner Bedding Sealing Ring: Compensating Displacement Seal (CDS), Outer Sheath Sealing Ring : Load Retention Seal (LRS)
Sealing Area(s)	Cable Inner Bedding & Outer Cable Sheath

* Mechanical & Electrical Classifications applied as per IEC 62444 & EN 62444
 ** When CMP installation accessories are used. Refer to page 7 or www.cmp-products.com for further information.
 *** IP68 tested to a minimum depth of 30 metres for 12 hours, alternate depths / durations can be provided upon request

Cable Gland Selection Table

Refer to illustration at the top of the page.

Dimensions for alternative threads may vary, please see supplementary technical data sheet

Cable Gland Size	Available Entry Threads "C" (Alternate Metric Thread Lengths Available)					Cable Bedding Diameter "A"		Overall Cable Diameter "B"		Armour Range †				Across Flats "D"	Across Corners "D"	Protrusion Length "F"	Combined Ordering Reference (*Brass Metric)			Shroud	Cable Gland Weight (Kgs)
	Standard		Option			Min	Max	Min	Max	Grooved Cone (X)		Stepped Cone (W)					Size	Type	Ordering Suffix		
	Metric	Thread Length (Metric) "E"	NPT	Thread Length (NPT) "E"	NPT					Min	Max	Min	Max	Min	Max	Min				Max	
16	M16	15.0	-	-	-	3.1	8.6	6.1	13.1	0.3	1.0	0.8	1.25	24.0	26.4	78.7	16	T3CDS	1RA	PVC36	0.18
20S16	M20	15.0	1/2"	19.9	3/4"	3.1	8.6	6.1	13.1	0.3	1.0	0.8	1.25	24.0	26.4	78.7	20S16	T3CDS	1RA	PVC36	0.20
20S	M20	15.0	1/2"	19.9	3/4"	6.1	11.6	9.5	15.9	0.3	1.0	0.8	1.25	24.0	26.4	78.7	20S	T3CDS	1RA	PVC36	0.20
20	M20	15.0	1/2"	19.9	3/4"	6.5	13.9	12.5	20.9	0.4	1.0	0.8	1.25	30.5	33.6	76.2	20	T3CDS	1RA	PVC06	0.28
25S	M25	15.0	3/4"	20.2	1"	11.1	19.9	14.0	22.0	0.4	1.2	1.25	1.6	37.5	41.3	88.8	25S	T3CDS	1RA	PVC09	0.44
25	M25	15.0	3/4"	20.2	1"	11.1	19.9	18.2	26.2	0.4	1.2	1.25	1.6	37.5	41.3	88.7	25	T3CDS	1RA	PVC09	0.44
32	M32	15.0	1"	25.0	1 1/4"	17.0	26.2	23.7	33.9	0.4	1.2	1.6	2.0	46.0	50.6	90.7	32	T3CDS	1RA	PVC11	0.63
40	M40	15.0	1 1/4"	25.6	1 1/2"	22.0	32.1	27.9	40.4	0.4	1.6	1.6	2.0	55.0	60.5	93.2	40	T3CDS	1RA	PVC15	0.91
50S	M50	15.0	1 1/2"	26.1	2"	29.5	38.1	35.2	46.7	0.4	1.6	2.0	2.5	60.0	66.0	100.7	50S	T3CDS	1RA	PVC18	1.12
50	M50	15.0	2"	26.9	2 1/2"	35.6	44.0	40.4	53.0	0.6	1.6	2.0	2.5	70.1	77.1	105.8	50	T3CDS	1RA	PVC21	1.60
63S	M63	15.0	2"	26.9	2 1/2"	40.1	49.9	45.6	59.4	0.6	1.6	2.0	2.5	75.0	82.5	102.5	63S	T3CDS	1RA	PVC23	1.73
63	M63	15.0	2 1/2"	39.9	3"	47.2	55.9	54.6	65.8	0.6	1.6	2.0	2.5	80.0	88.0	105.4	63	T3CDS	1RA	PVC25	1.78
75S	M75	15.0	2 1/2"	39.9	3"	52.8	61.9	59.0	72.0	0.6	1.6	2.0	2.5	90.0	99.0	110.6	75S	T3CDS	1RA	PVC28	2.57
75	M75	15.0	3"	41.5	3 1/2"	59.1	67.9	66.7	78.4	0.6	1.6	2.5	3.0	100.0	110.0	120.3	75	T3CDS	1RA	PVC30	3.33
90	M90	24.0	3 1/2"	42.8	4"	66.6	78.6	76.2	90.3	0.8	1.6	3.15	4.0	115.0	126.5	138.9	90	T3CDS	1RA	PVC32	4.87
100	M100	24.0	3 1/2"	42.8	4"	76.0	90.9	86.1	101.4	0.8	1.6	3.15	4.0	127.0	139.7	128.2	100	T3CDS	1RA	LSF33	4.97
115	M115	24.0	4"	44.0	5"	86.0	97.9	101.5	110.2	0.8	1.6	3.15	4.0	138.0	151.8	161.3	115	T3CDS	1RA	LSF34	7.72
130	M130	24.0	5"	46.8	-	97.0	114.9	110.2	123.2	0.8	1.6	3.15	4.0	157.0	172.7	173.3	130	T3CDS	1RA	LSF35	9.78

*For material options add the following suffix to the Ordering Reference; Brass (no suffix required), Nickel Plated Brass 'S', 316 Grade Stainless Steel '4', Copper Free Aluminium '1' For NPT options add the following digits to the material suffix; 1/2" = 31; 3/4" = 32; 1" = 33; 1 1/4" = 34; 1 1/2" = 35; 2" = 36; 2 1/2" = 37; 3" = 38; 3 1/2" = 39; 4" = 310 (Brass requires prefix '0')
 Examples: 32T3CDS1RA534 = Nickel Plated Brass 1 1/4" NPT, 50S13CDS1RA035 = Brass 1 1/2" NPT, 25T3CDS1RA432 = Stainless Steel 3/4" NPT, 20T3CDS1RA5 = Nickel Plated Brass M20

Dimensions are displayed in millimetres unless otherwise stated



TRITON
CDS

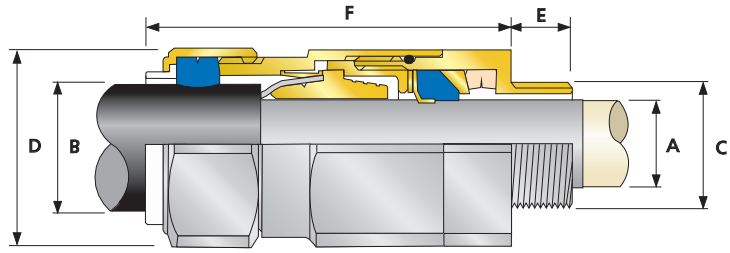

T3CDSPB



Triton CDS PB (T3CDSPB) Globally Approved, Explosive Atmosphere Cable Gland

For all types of Lead Sheathed Armoured Cables

- Effectively earths / grounds lead sheathed cables
- Fully sequential, three step installation procedure
- Direct & remote installation
- Unique compensating displacement seal system (CDS)
 - Metal-to-metal installation every time regardless of lead sheath diameter
- Designed to reduce the effects of Coldflow
- Integral protected deluge seal
- Controlled outer 'load retention' seal
- Unique OSTG prevents overtightening
- 60°C to +130°C
- Globally marked, IECEx, ATEX, UL & cCSAus
- Superior EMC performance



† Grooved Cone (X) is predominantly used for Wire Braid (e.g. GSWB, TCWB), Steel Tape Armour (STA, DSTA) and Aluminium Strip Armour (ASA) but is also suitable for Single Wire Armour (SWA), Aluminium Wire Armour (AWA) and Pliable Wire Armour (PWA) if the range is outside that of the Stepped Cone (W).

Grooved Cone (X) dimensions shown in the Cable Gland Selection Table below are for a double wire strand of braid armour cables. Tapes can also be doubled over. For cables that have only a single layer of armour such as SWA the clamping range should be used as shown in the table below.

Stepped (W) Cone is suitable for Single Wire Armour (SWA), or Aluminium Wire Armour (AWA) cables.

TECHNICAL DATA

Design Specification	BS 6121:Part 1:1989, IEC 62444, EN 62444
Mechanical Classification*	Impact = Level 8, Cable Anchorage = Class D
Enclosure Protection	IK10 to IEC 62262 (20 joules) Brass & Stainless Steel only
Electrical Classification*	Category B (Category A when used with braid, tape or pliable wire armour cables)
ATEX Certificate	SIRA13ATEX1073X, SIRA13ATEX4079X
Code of Protection	⊕ II 2G, II 1D, Ex d IIC Gb, Ex e IIC Gb, Ex ta IIC Da, Ex tG Ex nR IIC Gc, ⊕ I M2, Ex d I Mb, Ex e I Mb
Compliance Standards	EN 60079-0, 1, 7, 15, 31
IECEx Certificate	IECEx SIR 13.0028X, IECEx SIM 14.0007X
Code of Protection	Ex d IIC Gb, Ex e IIC Gb, Ex nR IIC Gc, Ex ta IIC Da, Ex d I Mb, Ex e I Mb
Compliance Standards	IEC 60079-0, 1, 7, 15, 31
EAC Certificate	TC RU C-GB.ГБ.05.В.00138
UkrSEPRO	UA.TR.047.C.0644-15
NEPSI Certificate	GYJ13.1141X / GYJ13.1283X
CCOE / PESO (India) Certificate	P333688
INMETRO Approval	TUV 11.0374X
RETIE Approval	03866
Marine Approvals	LRS: 01/00172 (E3), DNV: E-13848, ABS: 14-LD234401A-4-PDA, BV: 43180/A1
Ingress Protection Rating**	IP66, IP67 & IP68***
Deluge Protection Compliance	DTS01 : 91
Cable Gland Material	Brass, Electroless Nickel Plated Brass, Aluminium, Stainless Steel
Seal Material	CMP SOLO LSF Halogen Free Thermoset Elastomer
Cable Type	Lead Sheathed & Single Wire Armour (LC/SWA), Lead Sheathed & Aluminium Wire Armour (LC/AWA), Lead Sheathed & Wire Braid Armour (LC/SWB), Lead Sheathed & Pliable Wire Armour (LC/PWA), Lead Sheathed & Steel Tape Armour (LC/STA), Lead Sheathed & Aluminium Strip Armour (LC/ASA)
Armour Clamping	Reversible Armour Cone & AnyWay Universal Clamping Ring
Sealing Technique	Inner Bedding Sealing Ring: Compensating Displacement Seal (CDS), Outer Sheath Sealing Ring : Load Retention Seal (LRS)
Sealing Area(s)	Cable Inner Lead Covering & Cable Outer Sheath

* Mechanical & Electrical Classifications applied as per IEC 62444 & EN 62444

** When CMP installation accessories are used. Refer to page 7 or www.cmp-products.com for further information.

*** IP68 tested to a minimum depth of 30 metres for 12 hours, alternate depths / durations can be provided upon request

Cable Gland Selection Table

Refer to illustration at the top of the page.

Dimensions listed below are for metric cable glands only
Dimensions for alternative threads may vary, please see supplementary technical data sheet

Cable Gland Size	Available Entry Threads "C" (Alternate Metric Thread Lengths Available)					Lead Sheath Diameter "A"		Overall Cable Diameter "B"		Armour Range †				Across Flats "D"	Across Corners "D"	Protrusion Length "F"	Combined Ordering Reference (*Brass Metric)			Shroud	Cable Gland Weight (Kgs)
	Standard			Option		Min	Max	Min	Max	Grooved Cone (X)		Stepped Cone (W)					Size	Type	Ordering Suffix		
	Metric	Thread Length (Metric) "E"	NPT	Thread Length (NPT) "E"	NPT					Min	Max	Min	Max	Min	Max	Min				Max	
20S16	M20	15.0	½"	19.9	¾"	3.1	7.8	6.1	13.1	0.3	1.0	0.8	1.25	24.0	26.4	78.7	20S16	T3CDSPB	1RA	PVC36	0.20
20S	M20	15.0	½"	19.9	¾"	6.1	11.0	9.5	15.9	0.3	1.0	0.8	1.25	24.0	26.4	78.7	20S	T3CDSPB	1RA	PVC36	0.20
20	M20	15.0	½"	19.9	¾"	6.5	13.4	12.5	20.9	0.4	1.0	0.8	1.25	30.5	33.6	76.2	20	T3CDSPB	1RA	PVC06	0.28
25S	M25	15.0	¾"	20.2	1"	11.1	19.3	14.0	22.0	0.4	1.2	1.25	1.6	37.5	41.3	88.8	25S	T3CDSPB	1RA	PVC09	0.44
25	M25	15.0	¾"	20.2	1"	11.1	19.3	18.2	26.2	0.4	1.2	1.25	1.6	37.5	41.3	88.7	25	T3CDSPB	1RA	PVC09	0.44
32	M32	15.0	1"	25.0	1 ¼"	17.0	25.5	23.7	33.9	0.4	1.2	1.6	2.0	46.0	50.6	90.7	32	T3CDSPB	1RA	PVC11	0.64
40	M40	15.0	1 ¼"	25.6	1 ½"	22.0	31.2	27.9	40.4	0.4	1.6	1.6	2.0	55.0	60.5	93.2	40	T3CDSPB	1RA	PVC15	0.91
50S	M50	15.0	1 ½"	26.1	2"	29.5	37.2	35.2	46.7	0.4	1.6	2.0	2.5	60.0	66.0	100.7	50S	T3CDSPB	1RA	PVC18	1.13
50	M50	15.0	2"	26.9	2 ½"	35.6	42.6	40.4	53.0	0.6	1.6	2.0	2.5	70.1	77.1	105.8	50	T3CDSPB	1RA	PVC21	1.61
63S	M63	15.0	2"	26.9	2 ½"	40.1	48.5	45.6	59.4	0.6	1.6	2.0	2.5	75.0	82.5	102.5	63S	T3CDSPB	1RA	PVC23	1.74
63	M63	15.0	2 ½"	39.9	3"	47.2	54.2	54.6	65.8	0.6	1.6	2.0	2.5	80.0	88.0	105.4	63	T3CDSPB	1RA	PVC25	1.79
75S	M75	15.0	2 ½"	39.9	3"	52.8	60.2	59.0	72.0	0.6	1.6	2.0	2.5	90.0	99.0	110.6	75S	T3CDSPB	1RA	PVC28	2.58
75	M75	15.0	3"	41.5	3 ½"	59.1	65.2	66.7	78.4	0.6	1.6	2.5	3.0	100.0	110.0	120.3	75	T3CDSPB	1RA	PVC30	3.34
90	M90	24.0	3 ½"	42.8	4"	66.6	77.1	76.2	90.3	0.8	1.6	3.15	4.0	115.0	126.5	138.9	90	T3CDSPB	1RA	PVC32	4.89
100	M100	24.0	3 ½"	42.8	4"	76.0	88.1	86.1	101.4	0.8	1.6	3.15	4.0	127.0	139.7	128.2	100	T3CDSPB	1RA	LSF33	4.99
115	M115	24.0	4"	44.0	5"	86.0	94.1	101.5	110.2	0.8	1.6	3.15	4.0	138.0	151.8	161.3	115	T3CDSPB	1RA	LSF34	7.75
130	M130	24.0	5"	46.8	-	97.0	110.1	110.2	123.2	0.8	1.6	3.15	4.0	157.0	172.7	173.3	130	T3CDSPB	1RA	LSF35	9.81

*For material options add the following suffix to the Ordering Reference; Brass (no suffix required); Nickel Plated Brass '5'; 316 Grade Stainless Steel '4'; Copper Free Aluminium '1'
For NPT options add the following digits to the material suffix; ½" = 31; ¾" = 32; 1" = 33; 1 ¼" = 34; 1 ½" = 35; 2" = 36; 2 ½" = 37; 3" = 38; 3 ½" = 39; 4" = 310 (Brass requires prefix '0')

Examples: 32T3CDSPB1RA534 = Nickel Plated Brass 1 ¼" NPT, 50S T3CDSPB1RA035 = Brass 1 ½" NPT, 25T3CDSPB1RA432 = Stainless Steel ¾" NPT, 20T3CDSPB1RA5 = Nickel Plated Brass M20

Dimensions are displayed in millimetres unless otherwise stated

A-100 Series - A2F100, A2e100 & RA2e100

100% Pull Test Resistance

Zero Special Conditions

Conforming to the latest national and international technical standards, the CMP A-100 series of Explosive Atmospheres cable glands has been designed, tested and certified to withstand the rigorous "100% pull test".

Due to its unique design, the A-100 series (A2F100, A2e100, RA2e100) removes the need for a cable clamp or cleat before the point of entry where the cable gland is installed; saving time and expense, whilst delivering products that are among the safest in the world.

The displacement-type sealing rings used in the CMP A-100 series are designed for explosion protection and mechanical cable retention in compliance with IEC 60079-0:2011. These sealing rings exceed the requirements of Clause A3.1.1, Annex A, of IEC 60079-0:2011, which refers to the cable pull out resistance test of 'clamping non-armoured and braided cables'.

The A-100 series is intended for use with all types of unarmoured and braided cables in Zone 1, Zone 2, Zone 21 and Zone 22 Explosive Atmospheres complying to the latest IEC 60079 standards and Class I Division 2 Hazardous Locations.

Additional Features

- Ingress Protection - Offered by CMP Products in the A-100 series includes IEC 60529 specification tests IP66, IP67 & IP68 to a depth of 60 metres for a period of two weeks.
- Deluge Protected - The same products have undergone extensive deluge testing to DTS 01 : 91 which surpasses the conditions required by IEC 60529, with accelerated aging tests replicated by a thermal endurance programme applied before the deluge testing process.
- Supplied as standard with IP66, Increased Safety Ex e rated Ingress Disc for quick installation.



A2e100 in Nickel Plated Brass with Ingress Disc



Extreme Testing

In order to comply with IEC 60079-0:2011 cable glands must be tested for thermal endurance and then be capable of holding a variable but substantial force which is determined by the external cable diameter.

This thermal endurance test is designed to replicate the lifespan of the cable gland and sealing ring, and is intentionally harsh on the product's material and characteristics. Through extensive research and development and due to the high grade of materials used at CMP, the A-100 series functions without fail even after thermal conditioning.

Ultimately the IEC standard requires the cable gland to hold a polished steel mandrel (in place of a cable) , for a period of 6 hours, by use of the elastomeric sealing ring only, with a force in Newtons (N) applied equivalent to 20 times the cable diameter.

For a 20mm Ø cable, a 400N force is applied, which equates to 40.76Kgs with a maximum slippage of 6mm allowed. This is extremely difficult to achieve for most cable glands of this type.



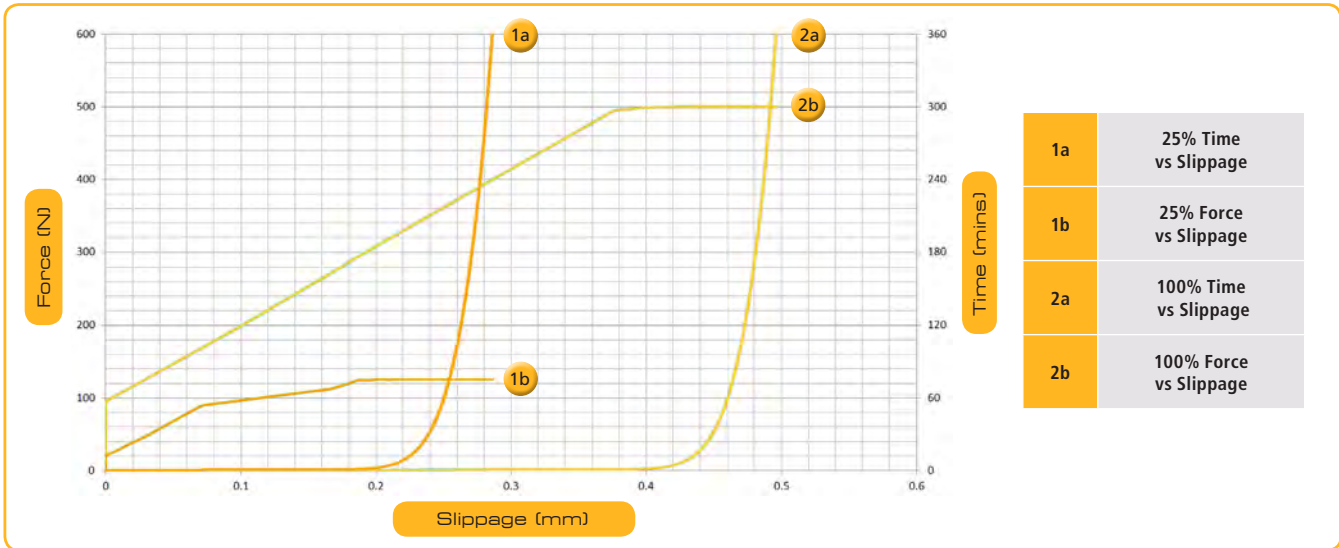

The graph above shows a CMP A-100 series cable gland compared with a standard (25%) A2F A series cable gland illustrating force and slippage plotted against time



Eliminating 'Special Conditions'

Where a product has not been tested to 100% load, or cannot meet the full test conditions of IEC 60079-0:2011, the standard permits a reduced load test equal to 25% of the declared values. In this case the product certification will contain a special condition, denoted by a suffix letter 'X' at the end of the certificate i.e. "Cable glands for use with unarmoured or braided cables are only suitable for fixed installations, the cable for which must be effectively clamped to prevent pulling and twisting".

When this condition exists there is a need, defined in various installation standards for explosive atmospheres, to securely anchor the cable within a specified distance (preferably 300mm from the end of the cable gland). This is to ensure that the results of any rotational movement or twisting, and pulling forces or tension are not transferred to the cable conductors and their terminations inside the enclosure.

The CMP A-100 series eliminates the need for this additional clamping and surpasses the requirements of IEC 60079-0:2011 without the need for any special conditions.

Image showing A2F100 and A2F explosive atmosphere cable glands from the A-100 and standard A series during cable anchorage test.

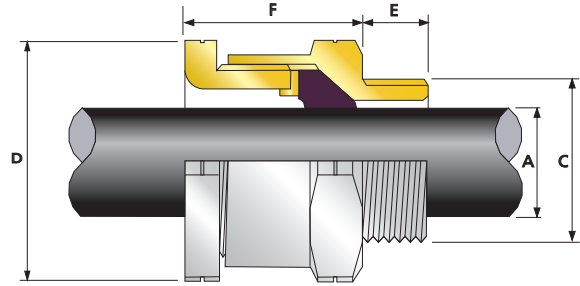

A2F100



A2F100 Globally Approved, Explosive Atmosphere Cable Gland

For all types of Unarmoured & Braided Cables

- Complies 100% with IEC 60079-0 cable retention requirements
- No special conditions for safe use
- No external cable clamping required by certification
- Displacement type flameproof seal
- Deluge protected
- -60°C to +130°C
- Globally marked, IECEx, ATEX
- Supplied with ingress disc



TECHNICAL DATA	
Design Specification	BS 6121:Part 1:1989, IEC 62444, EN 62444
Mechanical Classifications*	Impact = Level 8, Cable Anchorage = Class B
Enclosure Protection	IK10 to IEC 62262 (20 joules) Brass & Stainless Steel only
ATEX Certificate	SIRA16ATEX1018, SIRA16ATEX4020
Code of Protection	Ⓜ II 2G, II 1D Ex db IIC Gb, Ex eb IIC Gb, Ex ta IIC Da Ⓜ II 3G Ex nRc IIC Gc, Ⓜ I M2 Ex db I Mb, Ex eb I Mb
Compliance Standards	EN 60079-0,1,7,15,31
IECEx Certificate	IECEx SIR 16.0006
Code of Protection	Ex db IIC Gb, Ex eb IIC Gb, Ex nRc IIC Gc, Ex ta IIC Da, Ex db I Mb, Ex eb I Mb
Compliance Standards	IEC 60079-0,1,7,15,31
EAC Certificate (Formerly GOST R, K & B)	TC RU C-GB.ГБ05.В00138
KCC Certificate	13_GA4BO_0748X; 13_GA4BO_0749X; 13_GA4BO_0750X; 14_GA4BO_0251X
NEPSI Certificate	GYJ13.1140X / GYJ13.1282X
INMETRO Approval	TÜV 12.0619X
CCOE / PESO Certificate (India)	P333688
RETIE Approval Number	03866
Marine Approvals	LRS: 01/00172 (E3), DNV: E-13848, ABS: 14-LD234401A-4-PDA
Ingress Protection Rating**	IP66, IP67 & IP68***
Deluge Protection Compliance	DTS01 : 91
Cable Gland Material	Brass, Electroless Nickel Plated Brass, Stainless Steel, Aluminium
Seal Material	CMP SOLO LSF Halogen Free Thermoset Elastomer
Cable Type	Unarmoured & Braided
Sealing Technique	CMP Unique Displacement Seal Concept
Sealing Area(s)	Cable Outer Sheath

* Mechanical & Electrical Classifications applied as per IEC 62444 & EN 62444
 ** When CMP installation accessories are used. Refer to page 7 or www.cmp-products.com for further information.
 *** IP68 tested to a minimum depth of 30 metres for 12 hours, alternate depths / durations can be provided upon request

Cable Gland Selection Table

Refer to illustration at the top of the page.

Dimensions listed below are for metric cable glands only
 Dimensions for alternative threads may vary, please see supplementary technical data sheet

Cable Gland Size	Available Entry Threads "C" (Alternate Metric Thread Lengths Available)					Overall Cable Diameter "A"		Across Flats "D"	Across Corners "D"	Protrusion Length "F"	Combined Ordering Reference (*Brass Metric)			Shroud	Cable Gland Weight (Kgs)
	Standard			Option		Min	Max	Max	Max		Size	Type	Ordering Suffix		
	Metric	Thread Length (Metric) "E"	NPT	Thread Length (NPT) "E"	NPT										
16	M16	15.0	-	-	-	3.2	8.0	24.0	26.4	34.9	16	A2F100	1RA	PVC04	0.07
20S16	M20	15.0	½"	19.9	¾"	3.2	8.0	24.0	26.4	30.4	20S16	A2F100	1RA	PVC04	0.08
20S	M20	15.0	½"	19.9	¾"	6.5	11.2	24.0	26.4	31.9	20S	A2F100	1RA	PVC04	0.07
20	M20	15.0	½"	19.9	¾"	7.0	13.5	27.0	29.7	35.8	20	A2F100	1RA	PVC05	0.09
20L	M20	15.0	½"	19.9	¾"	8.7	14.0	27.0	29.7	34.3	20L	A2F100	1RA	PVC05	0.09
25	M25	15.0	¾"	20.2	1"	11.5	19.5	36.0	39.6	40.4	25	A2F100	1RA	PVC09	0.16
25L	M25	15.0	¾"	20.2	1"	14.0	20.0	36.0	39.6	39.9	25L	A2F100	1RA	PVC09	0.16
32	M32	15.0	1"	25.0	1 ¼"	19.0	25.5	41.0	45.1	38.5	32	A2F100	1RA	PVC10	0.18
32L	M32	15.0	1"	25.0	1 ¼"	20.2	26.3	41.0	45.1	35.5	32L	A2F100	1RA	PVC10	0.18
40	M40	15.0	1 ¼"	25.6	1 ½"	25.0	32.2	50.0	55.0	38.8	40	A2F100	1RA	PVC13	0.25
50S	M50	15.0	1 ½"	26.1	2"	31.0	38.2	55.0	60.5	41.4	50S	A2F100	1RA	PVC15	0.33
50	M50	15.0	2"	26.9	2 ½"	35.6	44.0	60.0	66.0	45.8	50	A2F100	1RA	PVC18	0.35
63S	M63	15.0	2"	26.9	2 ½"	41.5	49.9	70.5	77.6	43.3	63S	A2F100	1RA	PVC21	0.56
63	M63	15.0	2 ½"	39.9	3"	48.2	54.9	75.0	82.5	43.6	63	A2F100	1RA	PVC23	0.55
75S	M75	15.0	2 ½"	39.9	3"	54.0	61.9	84.0	92.4	45.4	75S	A2F100	1RA	PVC26	0.73
75	M75	15.0	3"	41.5	3 ½"	61.1	67.9	84.0	92.4	49.0	75	A2F100	1RA	PVC26	0.58
90	M90	24.0	3 ½"	42.8	4"	66.6	79.9	108.0	118.8	66.0	90	A2F100	1RA	PVC31	1.71
100	M100	24.0	3 ½"	42.8	4"	76.0	89.0	123.0	135.3	72.2	100	A2F100	1RA	LSF33	2.26
115	M115	24.0	4"	44.0	5"	86.0	97.9	133.4	146.7	67.9	115	A2F100	1RA	LSF34	2.74
130	M130	24.0	5"	46.8	-	97.0	114.9	152.4	167.6	81.1	130	A2F100	1RA	LSF35	4.07

*For material options add the following suffix to the Ordering Reference, Brass (no suffix required), Nickel Plated Brass '5', 316 Grade Stainless Steel '4', Copper Free Aluminium '1'
 NPT options add the following digits to the material suffix (NPT & Metric threads only available), ½" = 31; ¾" = 32; 1" = 33; 1 ¼" = 34; 1 ½" = 35; 2" = 36; 2 ½" = 37; 3" = 38; 3 ½" = 39; 4" = 310 (Brass requires prefix '0')
 Examples: 32A2F1001RA534 = Nickel Plated Brass 1 ¼" NPT, 50SA2F1001RA035 = Brass 1 ½" NPT, 25A2F1001RA432 = Stainless Steel ¾" NPT, 20A2F1001RA5 = Nickel Plated Brass M20

Dimensions are displayed in millimetres unless otherwise stated

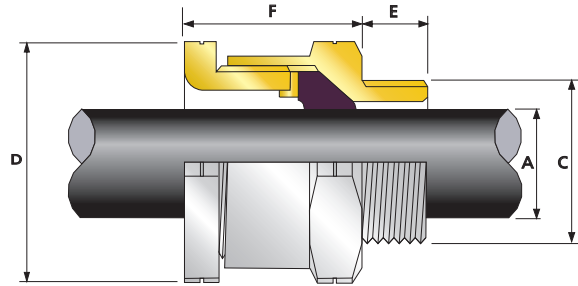

A2e100 Ex e Ex nR Ex ta

A2e100 Internationally Approved, Ex e, Explosive Atmosphere Cable Gland

For all types of Unarmoured & Braided Cables

- Complies 100% with IEC 60079-0 cable retention requirements
- No special conditions for safe use
- No external cable clamping required by certification
- Displacement type seal
- Deluge protected
- -60°C to +130°C
- Internationally marked, IECEx & ATEX
- 10mm thread lengths available upon request (sizes 32 and below)
- Supplied with ingress disc



TECHNICAL DATA	
Design Specification	BS 6121:Part 1:1989, IEC 62444, EN 62444
Mechanical Classifications*	Impact = Level 8, Cable Anchorage = Class B
Enclosure Protection	IK10 to IEC 62262 (20 joules) Brass & Stainless Steel only
ATEX Certificate	SIRA16ATEX3165, SIRA16ATEX4020
Code of Protection	⊕ II 2G Ex eb IIC Gb, II 1D Ex ta IIC Da ⊕ II 3G Ex nRc IIC Gc, ⊕ I M2 Ex eb I Mb
Compliance Standards	EN 60079-0,7,15,31
IECEx Certificate	IECEx SIR 16.0053
Code of Protection	Ex eb IIC Gb, Ex ta IIC Da, Ex nRc IIC Gc, Ex eb I Mb
Compliance Standards	IEC 60079-0,7,15,31
EAC Certificate	TC RU C-GB.F605.B00138
KCC Certificate	13_GA4B0_0749X; 13_GA4B0_0750X; 14_GA4B0_0251X
NEPSI Certificate	GYJ13.1140X / GYJ13.1282X
CCOE / PESO (India) Certificate	P333688
Marine Approvals	DNV: E-13848, ABS: 01LD234401B/2PDA, LRS: 01/00172 (E3)
Ingress Protection Rating**	IP66, IP67 & IP68***
Deluge Protection Compliance	DTS01 : 91
Cable Gland Material	Brass, Electroless Nickel Plated Brass, Stainless Steel, Aluminium
Seal Material	CMP SOLO LSF Halogen Free Thermoset Elastomer
Cable Type	Unarmoured & Braided
Sealing Technique	CMP Unique Displacement Seal Concept
Sealing Area(s)	Cable Outer Sheath

* Mechanical & Electrical Classifications applied as per IEC 62444 & EN 62444
 ** When CMP installation accessories are used. Refer to page 7 or www.cmp-products.com for further information.
 *** IP68 tested to a minimum depth of 30 metres for 12 hours, alternate depths / durations can be provided upon request

Cable Gland Selection Table

Refer to illustration at the top of the page.

Dimensions listed below are for metric cable glands only
 Dimensions for alternative threads may vary, please see supplementary technical data sheet

Cable Gland Size	Available Entry Threads "C" (Alternate Metric Thread Lengths Available)					Overall Cable Diameter "A"		Across Flats "D"	Across Corners "D"	Protrusion Length "F"	Combined Ordering Reference (*Brass Metric)			Shroud	Cable Gland Weight (Kgs)
	Standard		Option		Min	Max	Max	Max	Size		Type	Ordering Suffix			
	Metric	Thread Length (Metric) "E"	NPT	Thread Length (NPT) "E"									NPT		
16	M16	15.0	-	-	-	3.2	8.0	24.0	26.4	34.9	16	A2E100	1RA	PVC04	0.07
20S16	M20	15.0	1/2"	19.9	3/4"	3.2	8.0	24.0	26.4	30.4	20S16	A2E100	1RA	PVC04	0.08
20S	M20	15.0	1/2"	19.9	3/4"	6.5	11.2	24.0	26.4	31.9	20S	A2E100	1RA	PVC04	0.07
20	M20	15.0	1/2"	19.9	3/4"	7.0	13.5	27.0	29.7	35.8	20	A2E100	1RA	PVC05	0.08
20L	M20	15.0	1/2"	19.9	3/4"	8.7	14.0	27.0	29.7	34.3	20L	A2E100	1RA	PVC05	0.08
25	M25	15.0	3/4"	20.2	1"	11.5	19.5	36.0	39.6	40.4	25	A2E100	1RA	PVC09	0.16
25L	M25	15.0	3/4"	20.2	1"	14.0	20.0	36.0	39.6	39.9	25L	A2E100	1RA	PVC09	0.16
32	M32	15.0	1"	25.0	1 1/4"	19.0	25.5	41.0	45.1	38.5	32	A2E100	1RA	PVC10	0.19
32L	M32	15.0	1"	25.0	1 1/4"	20.2	26.3	41.0	45.1	35.5	32L	A2E100	1RA	PVC10	0.19
40	M40	15.0	1 1/4"	25.6	1 1/2"	25.0	32.2	50.0	55.0	38.8	40	A2E100	1RA	PVC13	0.25
50S	M50	15.0	1 1/2"	26.1	2"	31.0	38.2	55.0	60.5	41.4	50S	A2E100	1RA	PVC15	0.33
50	M50	15.0	2"	26.9	2 1/2"	35.6	44.0	60.0	66.0	45.8	50	A2E100	1RA	PVC18	0.35
63S	M63	15.0	2"	26.9	2 1/2"	41.5	49.9	70.5	77.6	43.3	63S	A2E100	1RA	PVC21	0.56
63	M63	15.0	2 1/2"	39.9	3"	48.2	54.9	75.0	82.5	43.6	63	A2E100	1RA	PVC23	0.55
75S	M75	15.0	2 1/2"	39.9	3"	54.0	61.9	84.0	92.4	45.4	75S	A2E100	1RA	PVC26	0.73
75	M75	15.0	3"	41.5	3 1/2"	61.1	67.9	84.0	92.4	49.0	75	A2E100	1RA	PVC26	0.58
90	M90	24.0	3 1/2"	42.8	4"	66.6	79.9	108.0	118.8	66.0	90	A2E100	1RA	PVC31	1.71
100	M100	24.0	3 1/2"	42.8	4"	76.0	89.0	123.0	135.3	72.2	100	A2E100	1RA	LSF33	2.26
115	M115	24.0	4"	44.0	5"	86.0	97.9	133.4	146.7	67.9	115	A2E100	1RA	LSF34	2.74
130	M130	24.0	5"	46.8	-	97.0	114.9	152.4	167.6	81.1	130	A2E100	1RA	LSF35	4.07

*For material options add the following suffix to the Ordering Reference; Brass (no suffix required); Nickel Plated Brass 'S'; 316 Grade Stainless Steel '4'; Copper Free Aluminium '1'
 NPT options add the following digits to the material suffix; 1/2" = 31; 3/4" = 32; 1" = 33; 1 1/4" = 34; 1 1/2" = 35; 2" = 36; 2 1/2" = 37; 3" = 38; 3 1/2" = 39; 4" = 310 (Brass requires prefix '0')
 Examples: 32A2E1001RA534 = Nickel Plated Brass 1 1/4" NPT, 50SA2E1001RA035 = Brass 1 1/2" NPT, 25A2E1001RA432 = Stainless Steel 3/4" NPT, 20A2E1001RA5 = Nickel Plated Brass M20

Dimensions are displayed in millimetres unless otherwise stated



A2F



A2F Globally Approved, Explosive Atmosphere Cable Gland

For all types of Unarmoured & Braided Cables

- Displacement type flameproof seal
- Deluge protected
- -60°C to +130°C (standard), -20°C to 200°C (ThermEx option)
- Globally marked, IECEx, ATEX & CSA

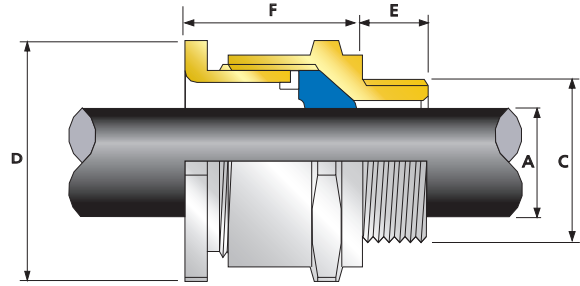

TECHNICAL DATA	
Design Specification	BS 6121:Part 1:1989, IEC 62444, EN 62444
Mechanical Classifications*	Impact = Level 8, Cable Anchorage = Class B
Enclosure Protection	IK10 to IEC 62262 (20 joules) Brass & Stainless Steel only
ATEX Certificate	SIRA13ATEX1068X, SIRA13ATEX4074X
Code of Protection	Ⓜ II 2G, II 1D Ex d IIC Gb, Ex e IIC Gb, Ex ta IIC Da Ⓜ II 3G Ex nR IIC Gc I M2 Ex d I Mb, Ex e I Mb
Compliance Standards	EN 60079-0,1,7,15,31
IECEx Certificate	IECEx SIR 13.0023X, IECEx SIM 14.0006
Code of Protection	Ex d IIC Gb, Ex e IIC Gb, Ex nR IIC Gc, Ex ta IIC Da, Ex d I Mb, Ex e I Mb
Compliance Standards	IEC 60079-0,1,7,15,31
CSA Certificate	1211841
Code of Protection	Class I, Div. 2 Groups B, C and D; Class II, Div. 2 Groups E, F and G; Class III, Div. 2; Type 4X: Oil Resistant II: Ex d IIC, Ex e II, Ex nR II
Compliance Standards	C22.2 No 0,0,4, 94, 174, CAN/CSA-E60079-0,1,7,15
EAC Certificate (Formerly GOST R, K & B)	TC RU C-GB.ГБ05.В00138
UkrSEPRO	UA.TR.047.C.0644-15
KCS Certificate	13_GA4B0_0748X ; 13_GA4B0_0749X ; 13_GA4B0_0750X ; 14_GA4B0_0251X
NEPSI Certificate	GYJ13.1140X / GYJ13.1282X
INMETRO Approval	TÜV 12.0619X
CCOE / PESO Certificate (India)	P333688
RETIE Approval Number	03866
Marine Approvals	LRS: 01/00172 (E3), DNV: E-13848, ABS: 14-LD234401A-4-PDA, BV: 43180/A1
Ingress Protection Rating**	IP66, IP67 & IP68***
Deluge Protection Compliance	DTS01 : 91
Cable Gland Material	Brass, Electroless Nickel Plated Brass, Stainless Steel, Aluminium
Seal Material	CMP SOLO LSF Halogen Free Thermoset Elastomer
Cable Type	Unarmoured & Braided when terminated inside enclosure
Sealing Technique	CMP Unique Displacement Seal Concept
Sealing Area(s)	Cable Outer Sheath

* Mechanical & Electrical Classifications applied as per IEC 62444 & EN 62444
 ** When CMP installation accessories are used. Refer to page 7 or www.cmp-products.com for further information.
 *** IP68 tested to a minimum depth of 30 metres for 12 hours, alternate depths / durations can be provided upon request

Cable Gland Selection Table

Refer to illustration at the top of the page.

Cable Gland Size	Available Entry Threads "C" (Alternate Metric Thread Lengths Available)					Overall Cable Diameter "A"		Across Flats "D"	Across Corners "D"	Protrusion Length "F"	Combined Ordering Reference (*Brass Metric)			Shroud	Cable Gland Weight (Kgs)
	Standard				Option	Min	Max	Max	Max		Size	Type	Ordering Suffix		
	Metric	Thread Length (Metric) "E"	NPT	Thread Length (NPT) "E"	NPT										
16	M16	15.0	-	-	-	3.2	8.7	24.0	26.4	29.9	16	A2F	1RA	PVC04	0.060
20S16	M20	15.0	½"	19.9	¾"	3.2	8.7	24.0	26.4	26.0	20S16	A2F	1RA	PVC04	0.070
20S	M20	15.0	½"	19.9	¾"	6.1	11.7	24.0	26.4	26.0	20S	A2F	1RA	PVC04	0.060
20	M20	15.0	½"	19.9	¾"	6.5	14.0	27.0	29.7	27.0	20	A2F	1RA	PVC05	0.070
25	M25	15.0	¾"	20.2	1"	11.1	20.0	36.0	39.6	35.5	25	A2F	1RA	PVC09	0.130
32	M32	15.0	1"	25.0	1 ¼"	17.0	26.3	41.0	45.1	35.1	32	A2F	1RA	PVC10	0.150
40	M40	15.0	1 ¼"	25.6	1 ½"	23.5	32.2	50.0	55.0	35.1	40	A2F	1RA	PVC13	0.200
50S	M50	15.0	1 ½"	26.1	2"	31.0	38.2	55.0	60.5	33.0	50S	A2F	1RA	PVC15	0.260
50	M50	15.0	2"	26.9	2 ½"	35.6	44.0	60.0	66.0	37.3	50	A2F	1RA	PVC18	0.270
63S	M63	15.0	2"	26.9	2 ½"	41.5	49.9	70.5	77.6	33.5	63S	A2F	1RA	PVC21	0.430
63	M63	15.0	2 ½"	39.9	3"	47.2	55.9	75.0	82.5	36.2	63	A2F	1RA	PVC23	0.400
75S	M75	15.0	2 ½"	39.9	3"	54.0	61.9	84.0	92.4	34.1	75S	A2F	1RA	PVC24	0.520
75	M75	15.0	3"	41.5	3 ½"	61.1	67.9	84.0	92.4	40.9	75	A2F	1RA	PVC26	0.500
90	M90	24.0	3 ½"	42.8	4"	66.6	79.9	108.0	118.8	60.3	90	A2F	1RA	PVC31	1.600
100	M100	24.0	3 ½"	42.8	4"	76.0	91.0	123.0	135.3	57.2	100	A2F	1RA	LSF33	1.780
115	M115	24.0	4"	44.0	5"	86.0	97.9	133.4	146.7	67.3	115	A2F	1RA	LSF34	2.670
130	M130	24.0	5"	46.8	-	97.0	114.9	152.4	167.6	74.7	130	A2F	1RA	LSF35	3.800

*For material options add the following suffix to the Ordering Reference, Nickel (no suffix required), Nickel Plated Brass '5', 316 Grade Stainless Steel '4', Copper Free Aluminium '1'
 For NPT options add the following digits to the material suffix, ½" = 31; ¾" = 32; 1" = 33; 1 ¼" = 34; 1 ½" = 35; 2" = 36; 2 ½" = 37; 3" = 38; 3 ½" = 39; 4" = 310 (Brass requires prefix '0')
 Examples: 32A2F1RA534 = Nickel Plated Brass 1 ¼" NPT, 50SA2F1RA035 = Brass 1 ½" NPT, 25A2F1RA432 = Stainless Steel ¾" NPT, 20A2F1RA5 = Nickel Plated Brass M20

Dimensions are displayed in millimetres unless otherwise stated

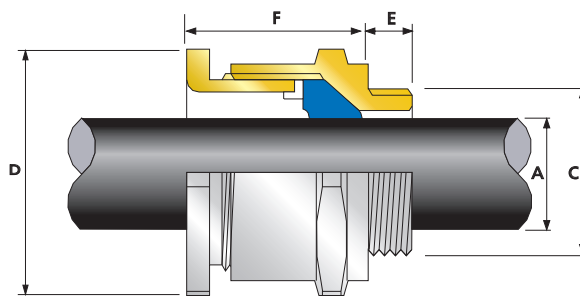
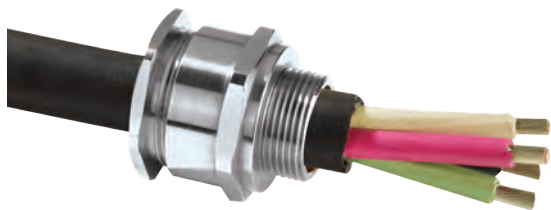

A2e



A2e Internationally Approved, Ex e, Explosive Atmosphere Cable Gland

For all types of Unarmoured & Braided Cables

- 10mm thread length on sizes 32 and below
- Displacement type seal
- Deluge protected
- -60°C to +130°C
- Internationally marked, IECEx & ATEX



TECHNICAL DATA

Design Specification	BS 6121:Part 1:1989, IEC 62444, EN 62444
Mechanical Classifications*	Impact = Level 8, Cable Anchorage = Class B
Enclosure Protection	IK10 to IEC 62262 (20 joules) Brass & Stainless Steel only
ATEX Certificate	SIRA13ATEX1068X, SIRA13ATEX4074X
Code of Protection	⊕ II 2G Ex e IIC Gb, II 1D Ex ta IIIC Da ⊕ II 3G Ex nR IIC Gc
Compliance Standards	EN 60079-0,7,31
IECEx Certificate	IECEx SIR 13.0023X, IECEx SIM 14.0006
Code of Protection	Ex e IIC Gb, Ex ta IIIC Da, Ex nR IIC Gc
Compliance Standards	IEC 60079-0,7,31
EAC Certificate	TC RU C-GB.Г505.В00138
KCS Certificate	13_GA4BO_0749X; 13_GA4BO_0750X; 14_GA4BO_0251X
NEPSI Certificate	GYJ13.1140X / GYJ13.1282X
CCOE / PESO (India) Certificate	P333688
Marine Approvals	DNV: E-13848, ABS: 16-LD1478091PDA, LRS: 01/00172 (E3), BV: 43180/A1
Ingress Protection Rating**	IP66, IP67 & IP68***
Deluge Protection Compliance	DTS01 : 91
Cable Gland Material	Brass, Electroless Nickel Plated Brass, Stainless Steel, Aluminium
Seal Material	CMP SOLO LSF Halogen Free Thermoset Elastomer
Cable Type	Unarmoured & Braided when terminated inside enclosure
Sealing Technique	CMP Unique Displacement Seal Concept
Sealing Area(s)	Cable Outer Sheath

* Mechanical & Electrical Classifications applied as per IEC 62444 & EN 62444
 ** When CMP installation accessories are used. Refer to page 7 or www.cmp-products.com for further information
 *** IP68 tested to a minimum depth of 30 metres for 12 hours, alternate depths / durations can be provided upon request.

Cable Gland Selection Table

Refer to illustration at the top of the page.

Dimensions listed below are for metric cable glands only
 Dimensions for alternative threads may vary, please see supplementary technical data sheet

Cable Gland Size	Available Entry Threads "C" (Alternate Metric Thread Lengths Available)					Overall Cable Diameter "A"		Across Flats "D"	Across Corners "D"	Protrusion Length "F"	Combined Ordering Reference (*Brass Metric)			Shroud	Cable Gland Weight (Kgs)
	Standard			Option							Size	Type	Ordering Suffix		
	Metric	Thread Length (Metric) "E"	NPT	Thread Length (NPT) "E"	NPT	Min	Max	Max	Max						
16	M16	10.0	-	-	-	3.2	8.7	24.0	26.4	28.6	16	A2E	1RA	PVC02	0.060
20S16	M20	10.0	½"	19.9	¾"	3.2	8.7	24.0	26.4	26.3	20S16	A2E	1RA	PVC04	0.070
20S	M20	10.0	½"	19.9	¾"	6.1	11.7	24.0	26.4	26.0	20S	A2E	1RA	PVC04	0.060
20	M20	10.0	½"	19.9	¾"	6.5	14.0	27.0	29.7	27.7	20	A2E	1RA	PVC05	0.070
25	M25	10.0	¾"	20.2	1"	11.1	20.0	36.0	39.6	36.3	25	A2E	1RA	PVC09	0.130
32	M32	10.0	1"	25.0	1 ¼"	17.0	26.3	41.0	45.1	35.1	32	A2E	1RA	PVC10	0.150
40	M40	15.0	1 ¼"	25.6	1 ½"	23.5	32.2	50.0	55.0	35.1	40	A2E	1RA	PVC13	0.200
50S	M50	15.0	1 ½"	26.1	2"	31.0	38.2	55.0	60.5	33.0	50S	A2E	1RA	PVC15	0.260
50	M50	15.0	2"	26.9	2 ½"	35.6	44.0	60.0	66.0	37.3	50	A2E	1RA	PVC18	0.270
63S	M63	15.0	2"	26.9	2 ½"	41.5	49.9	70.5	77.6	33.5	63S	A2E	1RA	PVC21	0.430
63	M63	15.0	2 ½"	39.9	3"	47.2	55.9	75.0	82.5	36.2	63	A2E	1RA	PVC23	0.400
75S	M75	15.0	2 ½"	39.9	3"	54.0	61.9	84.0	92.4	34.1	75S	A2E	1RA	PVC24	0.520
75	M75	15.0	3"	41.5	3 ½"	61.1	67.9	84.0	92.4	40.9	75	A2E	1RA	PVC26	0.500
90	M90	24.0	3 ½"	42.8	4"	66.6	79.9	108.0	118.8	60.3	90	A2E	1RA	PVC31	1.600
100	M100	24.0	3 ½"	42.8	4"	76.0	91.0	123.0	135.3	57.2	100	A2E	1RA	LSF33	1.780
115	M115	24.0	4"	44.0	5"	86.0	97.9	133.4	146.7	67.3	115	A2E	1RA	LSF34	2.670
130	M130	24.0	5"	46.8	-	97.0	114.9	152.4	167.6	74.7	130	A2E	1RA	LSF35	3.800

* For material options add the following suffix to the Ordering Reference; Brass (no suffix required); Nickel Plated Brass '5'; 316 Grade Stainless Steel '4'; Copper Free Aluminium '1'
 For NPT options add the following digits to the material suffix; ½" = 31; ¾" = 32; 1" = 33; 1 ¼" = 34; 1 ½" = 35; 2" = 36; 2 ½" = 37; 3" = 38; 3 ½" = 39; 4" = 310 (Brass requires prefix '0')
 Examples: 32A2E1RA534 = Nickel Plated Brass 1 ¼" NPT, 50SA2E1RA035 = Brass 1 ½" NPT, 25A2E1RA432 = Stainless Steel ¾" NPT, 20A2E1RA5 = Nickel Plated Brass M20

Dimensions are displayed in millimetres unless otherwise stated

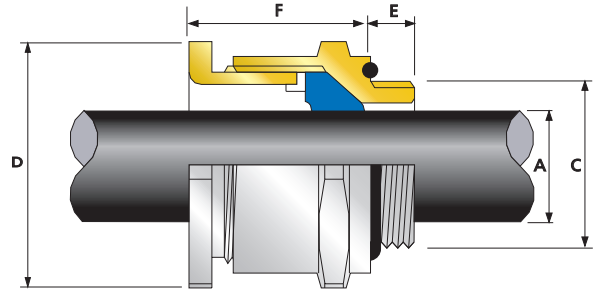
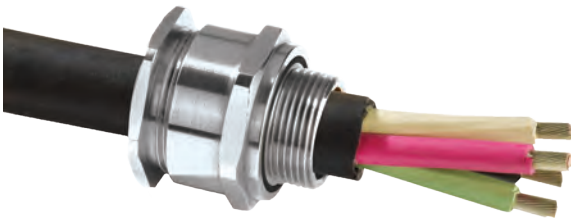

RA2e



RA2e Internationally Approved, Ex e, Explosive Atmosphere Cable Gland

For all types of Unarmoured & Braided Cables

- Supplied with face seal
- 10mm thread length on sizes 32 and below
- Displacement type seal
- Deluge protected
- -60°C to +130°C
- Internationally marked, IECEx & ATEX



TECHNICAL DATA	
Design Specification	BS 6121:Part 1:1989, IEC 62444, EN 62444
Mechanical Classifications*	Impact = Level 8, Cable Anchorage = Class B
Enclosure Protection	IK10 to IEC 62262 (20 joules) Brass & Stainless Steel only
ATEX Certificate	SIRA13ATEX1068X, SIRA13ATEX4074X
Code of Protection	Ⓜ II 2G II 1D Ex e IIC Gb, Ex ta IIIC Da Ⓜ II 3G Ex nR IIC Gc
Compliance Standards	EN 60079-0,7,31
IECEX Certificate	IECEX SIR 13.0023X, IECEX SIM 14.0006
Code of Protection	Ex e IIC Gb, Ex ta IIIC Da, Ex nR IIC Gc
Compliance Standards	IEC 60079-0,7,31
EAC Certificate	TC RU C-GB.ГБ05.В00138
KCS Certificate	13_GA4B0_0749X; 13_GA4B0_0750X; 14_GA4B0_0251X
NEPSI Certificate	GYJ13.1140X / GYJ13.1282X
CCOE / PESO (India) Certificate	P333688
Marine Approvals	DNV: E-13848, ABS: 16-LD1478091PDA, LRS: 01/00172 (E3)
Ingress Protection Rating**	IP66, IP67 & IP68***
Deluge Protection Compliance	DTS01 : 91
Cable Gland Material	Brass, Electroless Nickel Plated Brass, Stainless Steel, Aluminium
Seal Material	CMP SOLO LSF Halogen Free Thermoset Elastomer
Cable Type	Unarmoured & Braided when terminated inside enclosure
Sealing Technique	CMP Unique Displacement Seal Concept
Sealing Area(s)	Cable Outer Sheath

* Mechanical & Electrical Classifications applied as per IEC 62444 & EN 62444
 ** When CMP installation accessories are used. Refer to page 7 or www.cmp-products.com for further information.
 *** IP68 tested to a minimum depth of 30 metres for 12 hours, alternate depths / durations can be provided upon request

Cable Gland Selection Table

Refer to illustration at the top of the page.

Dimensions listed below are for metric cable glands only

Dimensions for alternative threads may vary, please see supplementary technical data sheet

Cable Gland Size	Available Entry Threads "C" (Alternate Metric Thread Lengths Available)					Overall Cable Diameter "A"		Across Flats "D"	Across Corners "D"	Protrusion Length "F"	Combined Ordering Reference ("Brass Metric")			Shroud	Cable Gland Weight (Kgs)
	Standard				Option	Min	Max	Max	Max		Size	Type	Ordering Suffix		
	Metric	Thread Length (Metric) "E"	NPT	Thread Length (NPT) "E"	NPT										
16	M16	10.0	-	-	-	3.2	8.7	27.0	29.7	29.4	16	RA2E	1RA	PVC02	0.060
20S16	M20	10.0	½"	19.9	¾"	3.2	8.7	27.0	29.7	26.2	20S16	RA2E	1RA	PVC04	0.070
20S	M20	10.0	½"	19.9	¾"	6.1	11.7	27.0	29.7	25.9	20S	RA2E	1RA	PVC04	0.060
20	M20	10.0	½"	19.9	¾"	6.5	14.0	27.0	29.7	27.4	20	RA2E	1RA	PVC05	0.070
25	M25	10.0	¾"	20.2	1"	11.1	20.0	36.0	39.6	35.9	25	RA2E	1RA	PVC09	0.130
32	M32	10.0	1"	25.0	1 ¼"	17.0	26.3	41.0	45.1	35.5	32	RA2E	1RA	PVC10	0.150
40	M40	15.0	1 ¼"	25.6	1 ½"	23.5	32.2	50.0	55.0	35.2	40	RA2E	1RA	PVC13	0.200
50S	M50	15.0	1 ½"	26.1	2"	31.0	38.2	60.0	66.0	33.9	50S	RA2E	1RA	PVC15	0.260
50	M50	15.0	2"	26.9	2 ½"	35.6	44.0	60.0	66.0	37.5	50	RA2E	1RA	PVC18	0.270
63S	M63	15.0	2"	26.9	2 ½"	41.5	49.9	75.0	82.5	34.7	63S	RA2E	1RA	PVC21	0.430
63	M63	15.0	2 ½"	39.9	3"	47.2	55.9	75.0	82.5	37.0	63	RA2E	1RA	PVC23	0.400
75S	M75	15.0	2 ½"	39.9	3"	54.0	61.9	90.0	99.0	34.7	75S	RA2E	1RA	PVC24	0.520
75	M75	15.0	3"	41.5	3 ½"	61.1	67.9	89.0	97.9	40.6	75	RA2E	1RA	PVC26	0.500
90	M90	24.0	3 ½"	42.8	4"	66.6	79.9	108.0	118.8	60.3	90	RA2E	1RA	PVC31	1.600
100	M100	24.0	3 ½"	42.8	4"	76.0	91.0	123.0	135.3	54.3	100	RA2E	1RA	LSF33	1.780
115	M115	24.0	4"	44.0	5"	86.0	97.9	133.4	146.7	66.2	115	RA2E	1RA	LSF34	2.670
130	M130	24.0	5"	46.8	-	97.0	114.9	152.4	167.6	74.8	130	RA2E	1RA	LSF35	3.800

*For material options add the following suffix to the Ordering Reference; Brass (no suffix required); Nickel Plated Brass 'S'; 316 Grade Stainless Steel '4'; Copper Free Aluminium '1'
 For NPT options add the following digits to the material suffix; ½" = 31; ¾" = 32; 1" = 33; 1 ¼" = 34; 1 ½" = 35; 2" = 36; 2 ½" = 37; 3" = 38; 3 ½" = 39; 4" = 310 (Brass requires prefix '0')
 Examples: 32RA2E1RA534 = Nickel Plated Brass 1 ¼" NPT, 50SRA2E1RA035 = Brass 1 ½" NPT, 25RA2E1RA432 = Stainless Steel ¾" NPT, 20RA2E1RA5 = Nickel Plated Brass M20

Dimensions are displayed in millimetres unless otherwise stated

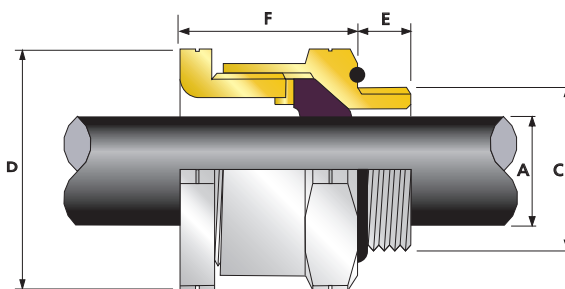

RA2e100



RA2e100 Internationally Approved, Ex e, Explosive Atmosphere Cable Gland

For all types of Unarmoured & Braided Cables

- Supplied with face seal
- Complies 100% with IEC 60079-0 cable retention requirements
- No special conditions for safe use
- No external cable clamping required by certification
- Displacement type seal
- Deluge protected
- -60°C to +130°C
- Internationally marked, IECEx & ATEX
- 10mm thread lengths available upon request (sizes 32 and below)
- Supplied with ingress disc



TECHNICAL DATA	
Design Specification	BS 6121:Part 1:1989, IEC 62444, EN 62444
Mechanical Classifications*	Impact = Level 8, Cable Anchorage = Class B
Enclosure Protection	IK10 to IEC 62262 (20 joules) Brass & Stainless Steel only
ATEX Certificate	SIRA16ATEX3165, SIRA16ATEX4020
Code of Protection	⊕ II 2G Ex eb IIC Gb, II 1D Ex ta IIIC Da ⊕ II 3G Ex nRc IIC Gc, ⊕ I M2 Ex eb I Mb
Compliance Standards	EN 60079-0,7,15,31
IECEx Certificate	IECEx SIR 16.0053
Code of Protection	Ex eb IIC Gb, Ex ta IIIC Da, Ex nRc IIC Gc, Ex eb I Mb
Compliance Standards	IEC 60079-0,7,15,31
EAC Certificate	TC RU C-GB.F505.B00138
KCC Certificate	13_GA4B0_0749X; 13_GA4B0_0750X; 14_GA4B0_0251X
NEPSI Certificate	GYJ13.1140X / GYJ13.1282X
CCOE / PESO (India) Certificate	P333688
Marine Approvals	DNV: E-13848, ABS: 01LD234401B/2PDA, LRS: 01/00172 (E3)
Ingress Protection Rating**	IP66, IP67 & IP68***
Deluge Protection Compliance	DTS01 : 91
Cable Gland Material	Brass, Electroless Nickel Plated Brass, Stainless Steel, Aluminium
Seal Material	CMP SOLO LSF Halogen Free Thermoset Elastomer
Cable Type	Unarmoured & Braided
Sealing Technique	CMP Unique Displacement Seal Concept
Sealing Area(s)	Cable Outer Sheath

* Mechanical & Electrical Classifications applied as per IEC 62444 & EN 62444
 ** When CMP installation accessories are used. Refer to page 7 or www.cmp-products.com for further information.
 *** IP68 tested to a minimum depth of 30 metres for 12 hours, alternate depths / durations can be provided upon request

Cable Gland Selection Table

Refer to illustration at the top of the page.

Dimensions listed below are for metric cable glands only
 Dimensions for alternative threads may vary, please see supplementary technical data sheet

Cable Gland Size	Available Entry Threads "C" (Alternate Metric Thread Lengths Available)					Overall Cable Diameter "A"		Across Flats "D"	Across Corners "D"	Protrusion Length "F"	Combined Ordering Reference ("Brass Metric)			Shroud	Cable Gland Weight (Kgs)
	Standard		Option		Min	Max	Max	Max	Size		Type	Ordering Suffix			
	Metric	Thread Length (Metric) "E"	NPT	Thread Length (NPT) "E"									NPT		
16	M16	15.0	-	-	-	3.2	8.0	24.0	26.4	34.9	16	RA2E100	1RA	PVC04	0.07
20S16	M20	15.0	1/2"	19.9	3/4"	3.2	8.0	27.0	29.7	31.4	20S16	RA2E100	1RA	PVC05	0.08
20S	M20	15.0	1/2"	19.9	3/4"	6.5	11.2	27.0	29.7	32.1	20S	RA2E100	1RA	PVC05	0.07
20	M20	15.0	1/2"	19.9	3/4"	7.0	13.5	27.0	29.7	35.8	20	RA2E100	1RA	PVC05	0.08
20L	M20	15.0	1/2"	19.9	3/4"	8.7	14.0	27.0	29.7	34.3	20L	RA2E100	1RA	PVC05	0.08
25	M25	15.0	3/4"	20.2	1"	11.5	19.5	36.0	39.6	40.4	25	RA2E100	1RA	PVC09	0.16
25L	M25	15.0	3/4"	20.2	1"	14.0	20.0	36.0	39.6	39.9	25L	RA2E100	1RA	PVC09	0.16
32	M32	15.0	1"	25.0	1 1/4"	19.0	25.5	41.0	45.1	38.5	32	RA2E100	1RA	PVC10	0.19
32L	M32	15.0	1"	25.0	1 1/4"	20.2	26.3	41.0	45.1	38.9	32L	RA2E100	1RA	PVC10	0.19
40	M40	15.0	1 1/4"	25.6	1 1/2"	25.0	32.2	50.0	55.0	39.1	40	RA2E100	1RA	PVC13	0.25
50S	M50	15.0	1 1/2"	26.1	2"	31.0	38.2	60.0	66.0	41.1	50S	RA2E100	1RA	PVC18	0.33
50	M50	15.0	2"	26.9	2 1/2"	35.6	44.0	60.0	66.0	45.8	50	RA2E100	1RA	PVC18	0.35
63S	M63	15.0	2"	26.9	2 1/2"	41.5	49.9	75.0	82.5	43.3	63S	RA2E100	1RA	PVC23	0.56
63	M63	15.0	2 1/2"	39.9	3"	48.2	54.9	75.0	82.5	43.6	63	RA2E100	1RA	PVC23	0.55
75S	M75	15.0	2 1/2"	39.9	3"	54.0	61.9	89.9	98.9	45.4	75S	RA2E100	1RA	PVC27	0.73
75	M75	15.0	3"	41.5	3 1/2"	61.1	67.9	89.9	98.9	49.0	75	RA2E100	1RA	PVC27	0.58
90	M90	24.0	3 1/2"	42.8	4"	66.6	79.9	108.0	118.8	66.0	90	RA2E100	1RA	PVC31	1.71
100	M100	24.0	3 1/2"	42.8	4"	76.0	89.0	123.0	135.3	71.2	100	RA2E100	1RA	LSF33	2.26
115	M115	24.0	4"	44.0	5"	86.0	97.9	133.4	146.7	69.9	115	RA2E100	1RA	LSF34	2.74
130	M130	24.0	5"	46.8	-	97.0	114.9	152.4	167.6	81.1	130	RA2E100	1RA	LSF35	4.07

*For material options add the following suffix to the Ordering Reference; Brass (no suffix required); Nickel Plated Brass '5'; 316 Grade Stainless Steel '4'; Copper Free Aluminium '1'
 NPT options add the following digits to the material suffix; 1/2" = 31; 3/4" = 32; 1" = 33; 1 1/4" = 34; 1 1/2" = 35; 2" = 36; 2 1/2" = 37; 3" = 38; 3 1/2" = 39; 4" = 310 (Brass requires prefix '0')
 Examples: 32RA2E1001RA534 = Nickel Plated Brass 1 1/4" NPT, 50SRA2E1001RA035 = Brass 1 1/2" NPT, 25RA2E1001RA432 = Stainless Steel 3/4" NPT, 20RA2E1001RA5 = Nickel Plated Brass M20

Dimensions are displayed in millimetres unless otherwise stated

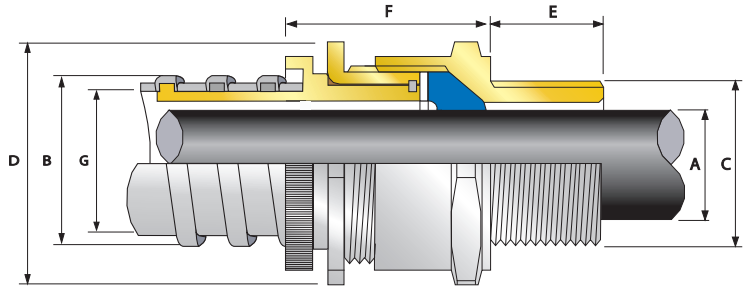

A2FFC



A2FFC Globally Approved, Flexible Conduit Explosive Atmosphere Cable Gland

For all types of Unarmoured & Braided Cables housed in Conduit

- Designed for flexible & rigid conduits
- Rigid conduits require thread adaptor from conduit supplier
- Suitable for conduit with rubber sheath / coating
- Displacement type flameproof seal
- -60°C to +130°C
- Globally marked, IECEx, ATEX & CSA



Alternative conduit sizes available upon request.
Ordering Suffix - e.g. C (conduit) 050 (CMP sizing reference)

TECHNICAL DATA	
Design Specification	BS 6121:Part 1:1989, IEC 62444, EN 62444
Mechanical Classifications*	Impact = Level 8, Cable Anchorage = Class B
Enclosure Protection	IK10 to IEC 62262 (20 joules) Brass & Stainless Steel only
ATEX Certificate	SIRA13ATEX1068X, SIRA13ATEX4074
Code of Protection	Ⓜ II 2G II 1D Ex d IIC Gb, Ex e IIC Gb, Ex ta IIC Da Ⓜ II 3G Ex nR IIC Gc, I M2 Ex d I Mb, Ex e I Mb
Compliance Standards	EN 60079-0,1,7,15,31
IECEx Certificate	IECEx SIR 13.0023X, IECEx SIM 14.0006
Code of Protection	Ex d IIC Gb, Ex e IIC Gb, Ex nR IIC Gc, Ex ta IIC Da, Ex d I Mb, Ex e I Mb
Compliance Standards	IEC 60079-0,1,7,15,31
CSA Certificate	1211841
Code of Protection	Ex d IIC, Ex e II, Ex nR II, Enclosure Type 4x
Compliance Standards	C22.2 No 0,0.4, 94, 174, CAN/CSA-E60079-0,1,7,15
EAC Certificate (Formerly GOST R, K & B)	TC RU C-GB.F605.B00138
UkrSEPRO	UA.TR.047.C.0644-15
KCS Certificate	13_GA4BO_0748X; 13_GA4BO_0749X; 13_GA4BO_0750X; 14_GA4BO_0251X
NEPSI Certificate	GYJ13.1140X / GYJ13.1282X
CCOE / PESO (India) Certificate	P333688
INMETRO Approval	TÜV 12.0878X
RETIE Approval Number	03866
Marine Approvals	LRS: 01/00172 (E3), ABS: 14-LD234401A-4-PDA
Ingress Protection Rating**	IP66
Standard Cable Gland Material	Brass, Electroless Nickel Plated Brass, Stainless Steel, Aluminium
Seal Material	CMP SOLO LSF Halogen Free Thermoset Elastomer
Cable Type	Unarmoured & Braided Housed in Flexible Conduit
Sealing Technique	CMP Displacement Seal
Sealing Area(s)	Outer Sheath

* Mechanical & Electrical Classifications applied as per IEC 62444 & EN 62444
** When CMP installation accessories are used. Refer to page 7 or www.cmp-products.com for further information.

Cable Gland Selection Table

Refer to illustration at the top of the page.

Dimensions listed below are for metric cable glands only
Dimensions for alternative threads may vary, please see supplementary technical data sheet

Cable Gland Size	Entry Threads "C"	Thread Length (Metric) "E" (Alternate Metric Thread Lengths Available)	Diameter of Cable "A"		Specific Internal Diameter of Conduit "G"	Maximum External Diameter of Conduit "B"	Across Flats "D"		Across Corners "D"	Protrusion Length "F"	Maximum Envelope Diameter	Combined Ordering Reference (*Brass Metric)			Cable Gland Weight (Kgs)
			Min	Max			Max	Max				Size	Type	Ordering Suffix	
20S16	M20 x 1.5	15.0	3.2	4.1	5.1	12.0	24.0	26.4	33.2	26.4	20S16	A2FFC	1RAC000	0.09	
20S16	M20 x 1.5	15.0	3.2	5.2	6.8	13.0	24.0	26.4	33.2	26.4	20S16	A2FFC	1RAC001	0.09	
20S16	M20 x 1.5	15.0	3.2	5.5	7.8	13.0	24.0	26.4	33.2	26.4	20S16	A2FFC	1RAC004	0.09	
20S16	M20 x 1.5	15.0	3.2	8.0	9.1	15.0	24.0	26.4	33.2	26.4	20S16	A2FFC	1RAC009	0.08	
20S16	M20 x 1.5	15.0	3.2	8.1	9.5	15.0	24.0	26.4	33.2	26.4	20S16	A2FFC	1RAC010	0.09	
20S16	M20 x 1.5	15.0	3.2	8.1	10.2	16.0	24.0	26.4	33.2	26.4	20S16	A2FFC	1RAC020	0.09	
20S16	M20 x 1.5	15.0	3.2	8.1	10.9	17.0	24.0	26.4	33.2	26.4	20S16	A2FFC	1RAC025	0.09	
20S16	M20 x 1.5	15.0	3.2	8.1	11.7	17.4	24.0	26.4	33.2	26.4	20S16	A2FFC	1RAC030	0.09	
20S	M20 x 1.5	15.0	6.1	11.4	13.0	20.0	24.0	26.4	33.1	26.4	20S	A2FFC	1RAC040	0.09	
20S	M20 x 1.5	15.0	6.1	11.7	13.9	20.0	24.0	26.4	33.1	26.4	20S	A2FFC	1RAC045	0.09	
20S	M20 x 1.5	15.0	6.1	11.7	14.7	21.5	24.0	26.4	33.1	26.4	20S	A2FFC	1RAC060	0.09	
20	M20 x 1.5	15.0	6.5	13.1	15.6	21.6	27.0	29.7	35.4	29.7	20	A2FFC	1RAC050	0.10	
20	M20 x 1.5	15.0	6.5	14.0	16.9	23.4	27.0	29.7	35.4	29.7	20	A2FFC	1RAC066	0.10	
20	M20 x 1.5	15.0	6.5	14.0	18.0	24.0	27.0	29.7	35.4	29.7	20	A2FFC	1RAC070	0.10	
20	M20 x 1.5	15.0	6.5	14.0	18.7	25.0	27.0	29.7	35.4	29.7	20	A2FFC	1RAC075	0.10	
20	M20 x 1.5	15.0	6.5	14.0	20.0	26.3	27.0	29.7	35.4	29.7	20	A2FFC	1RAC080	0.12	
20	M20 x 1.5	15.0	6.5	14.0	20.5	28.0	27.0	29.7	35.4	31.0	20	A2FFC	1RAC085	0.11	
25	M25 x 1.5	15.0	11.1	15.3	17.6	25.0	36.0	39.6	43.1	39.6	25	A2FFC	1RAC100	0.16	
25	M25 x 1.5	15.0	11.1	18.4	20.7	27.0	36.0	39.6	43.1	39.6	25	A2FFC	1RAC105	0.16	
25	M25 x 1.5	15.0	11.1	19.0	22.3	28.5	36.0	39.6	43.1	39.6	25	A2FFC	1RAC110	0.17	
25	M25 x 1.5	15.0	11.1	20.0	23.7	32.0	36.0	39.6	43.1	39.6	25	A2FFC	1RAC115	0.18	
25	M25 x 1.5	15.0	11.1	20.0	25.1	31.0	36.0	39.6	43.1	39.6	25	A2FFC	1RAC120	0.17	
25	M25 x 1.5	15.0	11.1	20.0	26.5	35.0	36.0	39.6	43.1	39.6	25	A2FFC	1RAC180	0.18	
32	M32 x 1.5	15.0	17.0	26.0	28.1	35.8	41.0	45.1	43.1	45.1	32	A2FFC	1RAC250	0.21	
32	M32 x 1.5	15.0	17.0	26.3	30.4	38.0	41.0	45.1	43.1	45.1	32	A2FFC	1RAC280	0.21	
32	M32 x 1.5	15.0	17.0	26.3	34.6	45.0	41.0	45.1	43.6	48.0	32	A2FFC	1RAC290	0.25	
40	M40 x 1.5	15.0	23.5	32.2	36.4	45.0	50.0	55.0	45.1	55.0	40	A2FFC	1RAC300	0.28	
40	M40 x 1.5	15.0	23.5	32.2	40.0	49.0	50.0	55.0	45.1	55.0	40	A2FFC	1RAC380	0.30	
50S	M50 x 1.5	15.0	31.0	38.2	46.5	58.7	55.0	60.5	43.8	63.7	50S	A2FFC	1RAC450	0.48	
50S	M50 x 1.5	15.0	31.0	38.2	51.2	61.0	55.0	60.5	43.8	65.0	50S	A2FFC	1RAC500	0.49	
50	M50 x 1.5	15.0	35.6	44.0	51.2	61.0	60.0	66.0	48.0	66.0	50	A2FFC	1RAC550	0.49	

*For material options add the following suffix to the Ordering Reference; Brass (no suffix required); Nickel Plated Brass '5'; 316 Grade Stainless Steel '4'; Copper Free Aluminium '1'
For NPT options please add the following digits to the material suffix; 1/2" = 31, 3/4" = 32, 1" = 33, 1 1/4" = 34, 1 1/2" = 35, 2" = 36, 2 1/2" = 37, 3" = 38, 3 1/2" = 39 (Brass requires prefix "0")

Examples: 32A2FFC1RA534C290 = Nickel Plated Brass 1 1/4" NPT suitable for conduit sized 35.0 ID - 43.0 OD, 50SA2FFC1RA035C500 = Brass 1 1/2" NPT, 20A2FFC1RA5C075 = Nickel Plated Brass M20 suitable for conduit sized 18.7 ID - 24.0 OD

Dimensions are displayed in millimetres unless otherwise stated

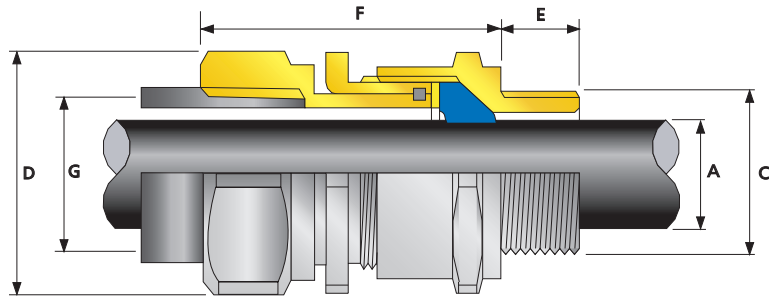

A2FRC



A2FRC Globally Approved, Rigid & Flexible Conduit Explosive Atmosphere Cable Gland

For all types of Unarmoured & Braided Cables housed in Conduit

- Designed for rigid & flexible conduits
- Easy install running coupler design
- Displacement type flameproof seal
- -60°C to +130°C
- Globally marked, IECEx, ATEX & CSA



Alternative conduit sizes available upon request.

See cable gland selection table below for full NPT & Metric thread ordering references

THREAD OPTION ORDERING EXAMPLES

Ordering Reference	Male Thread	Female Thread
20A2FRC1RA	M20	M20
20A2FRC1RA031	M20	1/2" NPT
20A2FRC1RA03131	1/2" NPT	1/2" NPT
20A2FRC1RA03102*	1/2" NPT	M20

Refer to 'How to order' page for complete list of ordering codes.
 * For Metric female threads please insert '0' before thread size code
 e.g. 32A2FRC1RA53405 (1 - 1/4" NPT Male x M40 Female)

TECHNICAL DATA

Design Specification	BS 6121:Part 1:1989, IEC 62444, EN 62444
Mechanical Classifications*	Impact = Level 8, Cable Anchorage = Class B
Enclosure Protection	IK10 to IEC 62262 (20 joules) Brass & Stainless Steel only
ATEX Certificate	SIRA13ATEX1068X, SIRA13ATEX4074X
Code of Protection	Ⓔ II 2G II 1D Ex d IIC Gb, Ex e IIC Gb, Ex ta IIIC Da, II 3G Ex nR IIC Gc
Compliance Standards	EN 60079-0,1,7,15,31
IECEx Certificate	IECEx SIR 13.0023X, IECEx SIM 14.0006
Code of Protection	Ex d IIC Gb, Ex e IIC Gb, Ex nR IIC Gc, Ex ta IIIC Da
Compliance Standards	IEC 60079-0,1,7,15,31
CSA Certificate	1211841
Code of Protection	Ex d IIC, Ex e II, Ex nR II, Enclosure Type 4x
Compliance Standards	C22.2 No 0,0,4, 94,174, CAN/CSA-E60079-0,1,7, 15
EAC Certificate	TC RU C-GB.ГБ05.В00138
UkrSEPRO	UA.TR.047.C.0644-15
KCS Certificate	13_GA4B0_0748X ; 13_GA4B0_0749X ; 13_GA4B0_0750X ; 14_GA4B0_0251X
CCOE / PESO (India) Certificate	P333688
NEPSI Certificate	GY13.1140X / GY13.1282X
INMETRO Approval	TÜV 12.0878X
RETIE Approval Number	03866
Marine Approvals	LRS: 01/00172 (E3), DNV: E-13848, BV: 43180/A1
Ingress Protection Rating**	IP66
Cable Gland Material	Brass, Electroless Nickel Plated Brass, Aluminium, Stainless Steel
Seal Material	CMP SOLO LSF Halogen Free Thermoset Elastomer
Cable Type	Unarmoured & Braided when terminated inside enclosure
Sealing Technique	CMP Unique Displacement Seal Concept
Sealing Area(s)	Cable Outer Sheath

* Mechanical & Electrical Classifications applied as per IEC 62444 & EN 62444

** When CMP installation accessories are used. Refer to page 7 or www.cmp-products.com for further information.

Cable Gland Selection Table

Refer to illustration at the top of the page.

Cable Gland Size	Available Entry Threads "C" (Alternate Metric Thread Lengths Available)					Female Connection Thread "G"	Female Connection Thread (NPT) "G"	Overall Cable Diameter "A"		Across Flats "D"	Across Corners "D"	Protrusion Length "F"	Combined Ordering Reference (*Brass Metric male and female)			Shroud	Cable Gland Weight (Kgs)		
	Metric	Thread Length (Metric) "E"	NPT	Thread Length (NPT) "E"	Option			Min	Max				Max	Max	Size			Type	Ordering Suffix
20S16	M20	15.0	1/2"	19.9	3/4"	M20	1/2"	3.2	8.7	24.0	26.4	46.9	20S16	A2FRC	1RA	PVC04	0.110		
20S	M20	15.0	1/2"	19.9	3/4"	M20	1/2"	6.1	11.7	24.0	26.4	46.1	20S	A2FRC	1RA	PVC04	0.110		
20	M20	15.0	1/2"	19.9	3/4"	M20	1/2"	6.5	14.0	27.0	29.7	47.9	20	A2FRC	1RA	PVC05	0.110		
25	M25	15.0	3/4"	20.2	1"	M25	3/4"	11.1	20.0	36.0	39.6	56.1	25	A2FRC	1RA	PVC09	0.200		
32	M32	15.0	1"	25.0	1 1/4"	M32	1"	17.0	26.3	41.0	45.1	55.5	32	A2FRC	1RA	PVC10	0.240		
40	M40	15.0	1 1/4"	25.6	1 1/2"	M40	1 1/4"	23.5	32.2	50.0	55.0	57.7	40	A2FRC	1RA	PVC13	0.330		
50S	M50	15.0	1 1/2"	26.1	2"	M50	1 1/2"	31.0	38.2	55.0	60.5	59.1	50S	A2FRC	1RA	PVC15	0.430		
50	M50	15.0	2"	26.9	2 1/2"	M50	2"	35.6	44.0	60.0	66.0	64.3	50	A2FRC	1RA	PVC18	0.440		
63S	M63	15.0	2"	26.9	2 1/2"	M63	2"	41.5	49.9	70.5	77.6	61.6	63S	A2FRC	1RA	PVC21	0.720		
63	M63	15.0	2 1/2"	39.9	3"	M63	2 1/2"	47.2	55.9	75.0	82.5	71.0	63	A2FRC	1RA	PVC23	0.640		
75S	M75	15.0	2 1/2"	39.9	3"	M75	2 1/2"	54.0	61.9	84.0	92.4	70.1	75S	A2FRC	1RA	PVC26	0.960		
75	M75	15.0	3"	41.5	3 1/2"	M75	3"	61.1	67.9	84.0	92.4	73.2	75	A2FRC	1RA	PVC26	0.860		
90	M90	24.0	3 1/2"	42.8	4"	M90	3 1/2"	66.6	79.9	108.0	118.8	106.3	90	A2FRC	1RA	PVC31	2.250		
100	M100	24.0	3 1/2"	42.8	4"	M100	3 1/2"	76.0	91.0	123.0	135.5	115.8	100	A2FRC	1RA	LSF33	3.860		
115	M115	24.0	4"	44.0	5"	M115	4"	86.0	97.9	133.4	146.7	117.3	115	A2FRC	1RA	LSF34	4.500		
130	M130	24.0	5"	46.8	-	M130	5"	97.0	114.9	152.4	167.6	120.0	130	A2FRC	1RA	LSF35	4.770		

*For material options add the following suffix to the Ordering Reference: Brass (no suffix required); Nickel Plated Brass 'S'; 316 Grade Stainless Steel '4'; Copper Free Aluminium '1'

For NPT male and/or female options please add the following digits to the material suffix (See Thread Options table above) 1/2" = 31, 3/4" = 32, 1" = 33, 1 1/4" = 34, 1 1/2" = 35, 2" = 36, 2 1/2" = 37, 3" = 38, 3 1/2" = 39, 4" = 310 (Brass requires prefix '0')

NPT male & Metric female product option is required, please add the following digits to the material and NPT male suffix (See Thread Options table) M1G=01, M2G=02, M2S=03, M2=04, M4G=05, M5G=06, M6G=07, M7S=08, M9G=09 (Brass requires prefix '0')

Examples: 32A2FRC1RA533 = Nickel Plated Brass M32 male x 1" NPT female, 20S16A2FRC1RA031 = Brass M20 male x 1/2" NPT female, 25A2FRC1RA43202 = Stainless Steel 1/2" NPT male x M25 female, 20A2FRC1RA5 = Nickel Plated Brass M20 male & female

Dimensions are displayed in millimetres unless otherwise stated

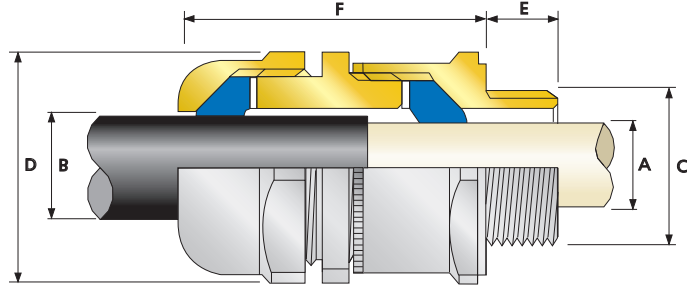

SS2K



SS2K Double Seal, Globally Approved, Explosive Atmosphere Cable Gland

For all types of Unarmoured & Braided Cables

- Provides double seal on outer sheath or single on outer & inner
- Direct & remote installation
- Superior levels of cable retention
- Displacement type flameproof seals
- Deluge protected
- Secure against self-loosening
- -60°C to +130°C (standard), -20°C to 200°C (ThermEx option)
- Ex e only version available
- Globally marked, IECEx, ATEX & CSA



TECHNICAL DATA	
Design Specification	BS 6121:Part 1:1989, IEC 62444, EN 62444
Mechanical Classifications*	Impact = Level 8, Cable Anchorage = Class B
Enclosure Protection	IK10 to IEC 62262 (20 joules) Brass & Stainless Steel only
ATEX Certificate	SIRA13ATEX1069X, SIRA13ATEX4075X
Code of Protection	Ⓜ II 2G, II 1D, Ex d IIC Gb, Ex e IIC Gb, Ex ta IIIC Da Ⓜ II 3G Ex nR IIC Gc, Ⓜ IM2 Ex d I Mb, Ex e I Mb
Compliance Standards	EN 60079-0,1,7,15,31
IECEx Certificate	IECEx SIR 13.0024X, IECEx SIM 14.0006
Code of Protection	Ex d IIC Gb, Ex e IIC Gb, Ex nR IIC Gc, Ex ta IIIC Da, Ex d I Mb, Ex e I Mb
Compliance Standards	IEC 60079-0,1,7,15,31
CSA Certificate	1211841
Code of Protection	Ex d IIC, Ex e II, Ex nR II, Enclosure Type 4x Class I, Div. 2, Groups B,C & D
Compliance Standards	C22.2 No 0,0,4, 94, 174, CAN/CSA-E60079-0,1,7, 15
EAC Certificate	TC RU C-GB.ГБ05.В00138
UkrSEPRO	UA.TR.047.C.0644-15
NEPSI Certificate	GYJ13.1140X / GYJ13.1282X
CCOE / PESO (India) Certificate	P333688
INMETRO Approval	TÜV 12.0879X
RETIE Approval Number	03866
Marine Approvals	LRS: 01/00172 (E3), DNV: E-13848, ABS: 14-LD234401A-4-PDA, BV: 43180/A1
Ingress Protection Rating**	IP66, IP67 & IP68***
Cable Gland Material	Brass, Electroless Nickel Plated Brass, Stainless Steel, Aluminium
Seal Material	CMP SOLO LSF Halogen Free Thermoset Elastomer
Cable Type	Unarmoured & Braided
Sealing Technique	CMP Unique Displacement Seal Concept
Sealing Area(s)	Cable Inner Bedding & Outer Cable Sheath, Double Seal on Cable Outer Sheath

* Mechanical & Electrical Classifications applied as per IEC 62444 & EN 62444
 ** When CMP installation accessories are used. Refer to page 7 or www.cmp-products.com for further information.
 *** IP68 tested to a minimum depth of 30 metres for 12 hours, alternate depths / durations can be provided upon request

Cable Gland Selection Table

Refer to illustration at the top of the page.

Dimensions listed below are for metric cable glands only
 Dimensions for alternative threads may vary, please see supplementary technical data sheet

Cable Gland Size	Available Entry Threads "C" (Alternate Metric Thread Lengths Available)					Cable Bedding Diameter "A"		Overall Cable Diameter "B"		Across Flats "D"	Across Corners "D"	Protrusion Length "F"	Combined Ordering Reference (*Brass Metric)			Shroud	Cable Gland Weight (Kgs)
	Metric	Standard		Option		Min	Max	Min	Max				Size	Type	Ordering Suffix		
		Thread Length (Metric) "E"	NPT	Thread Length (NPT) "E"	NPT												
20S16	M20	15.0	1/2"	19.9	3/4"	3.2	8.6	3.2	8.6	24.0	26.4	49.0	20S16	SS2K	1RA	PVC04	0.140
20S	M20	15.0	1/2"	19.9	3/4"	6.1	11.7	6.1	11.7	24.0	26.4	49.0	20S	SS2K	1RA	PVC04	0.130
20	M20	15.0	1/2"	19.9	3/4"	6.5	14.0	6.5	14.0	27.0	29.7	54.0	20	SS2K	1RA	PVC05	0.160
25	M25	15.0	3/4"	20.2	1"	11.1	20.0	11.1	20.0	36.0	39.6	66.0	25	SS2K	1RA	PVC09	0.300
32	M32	15.0	1"	25.0	1 1/4"	17.0	26.3	17.0	26.3	41.0	45.1	67.0	32	SS2K	1RA	PVC10	0.350
40	M40	15.0	1 1/4"	25.6	1 1/2"	23.5	32.1	23.5	32.1	50.0	55.0	70.0	40	SS2K	1RA	PVC13	0.500
50S	M50	15.0	1 1/2"	26.1	2"	31.0	38.2	31.0	38.2	55.0	60.5	65.0	50S	SS2K	1RA	PVC15	0.560
50	M50	15.0	2"	26.9	2 1/2"	35.6	44.0	35.6	44.0	60.0	66.0	70.0	50	SS2K	1RA	PVC18	0.590
63S	M63	15.0	2"	26.9	2 1/2"	41.5	49.9	41.5	49.9	70.5	77.6	70.0	63S	SS2K	1RA	PVC21	0.890
63	M63	15.0	2 1/2"	39.9	3"	47.2	55.9	47.2	55.9	75.0	82.5	71.0	63	SS2K	1RA	PVC23	0.850
75S	M75	15.0	2 1/2"	39.9	3"	54.0	61.9	54.0	61.9	80.0	88.0	70.0	75S	SS2K	1RA	PVC25	1.020
75	M75	15.0	3"	41.5	3 1/2"	61.1	67.9	61.1	67.9	84.0	92.4	75.0	75	SS2K	1RA	PVC26	0.990
90	M90	24.0	3 1/2"	42.8	4"	66.6	79.4	66.6	79.4	108.0	118.8	113.0	90	SS2K	1RA	PVC31	2.990
100	M100	24.0	3 1/2"	42.8	4"	76.0	90.9	76.0	90.9	123.0	134.2	106.0	100	SS2K	1RA	LSF33	3.390
115	M115	24.0	4"	44.0	5"	86.0	97.9	86.0	97.9	133.4	146.7	128.0	115	SS2K	1RA	LSF34	5.320
130	M130	24.0	5"	46.8	-	97.0	114.9	97.0	114.9	152.4	167.6	129.0	130	SS2K	1RA	LSF35	6.350

*For material options add the following suffix to the Ordering Reference; Brass (no suffix required); Nickel Plated Brass 'S'; 316 Grade Stainless Steel '4'; Copper Free Aluminium '1'
 For NPT options add the following digits to the material suffix; 1/2" = 31; 3/4" = 32; 1" = 33; 1 1/4" = 34; 1 1/2" = 35; 2" = 36; 2 1/2" = 37; 3" = 38; 3 1/2" = 39; 4" = 310 (Brass requires prefix '0')

Examples: 32SS2K1RA534 = Nickel Plated Brass 1 1/4" NPT, 50SS2K1RA035 = Brass 1 1/2" NPT, 25SS2K1RA432 = Stainless Steel 3/4" NPT, 20SS2K1RA5 = Nickel Plated Brass M20

Dimensions are displayed in millimetres unless otherwise stated

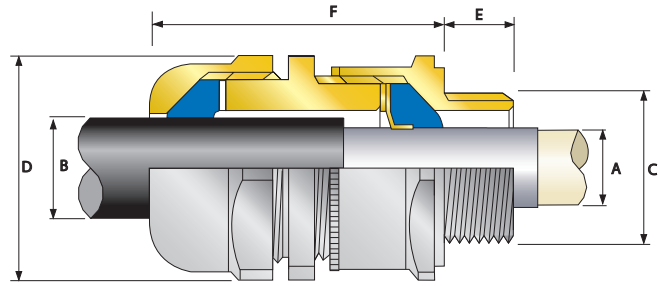

SS2KPB



SS2KPB Double Seal, Internationally Approved, Explosive Atmosphere Cable Gland

For all types of Lead Sheathed Unarmoured Cables

- Effectively earths / grounds lead sheathed cables
- Direct & remote installation
- Superior levels of cable retention
- Displacement type flameproof seals
- Secure against self-loosening
- -60°C to +130°C
- Internationally marked, IECEx & ATEX



TECHNICAL DATA

Design Specification	BS 6121:Part 1:1989, IEC 62444, EN 62444
Mechanical Classifications*	Impact = Level 8, Cable Anchorage = Class B
Enclosure Protection	IK10 to IEC 62262 (20 joules) Brass & Stainless Steel only
ATEX Certificate	SIRA13ATEX1069X, SIRA13ATEX4075X
Code of Protection	Ⓜ II 2G, II 1D, Ex d IIC Gb, Ex e IIC Gb, Ex ta IIIC Da Ⓜ II 3G Ex nR IIC Gc, Ⓜ IM2 Ex d I Mb, Ex e I Mb
Compliance Standards	EN 60079-0,1,7,15,31
IECEx Certificate	IECEx SIR 13.0024X, IECEx SIM 14.0006
Code of Protection	Ex d IIC Gb, Ex e IIC Gb, Ex nR IIC Gc, Ex ta IIIC Da, Ex d I Mb, Ex e I Mb
Compliance Standards	IEC 60079-0,1,7,15,31
EAC Certificate	TC RU C-GB.ГБ05.В00138
UkrSEPRO	UA.TR.047.C.0644-15
NEPSI Certificate	GYJ13.1140X / GYJ13.1282X
CCOE / PESO (India) Certificate	P333688
INMETRO Approval	TÜV 12.0879X
RETIE Approval Number	03866
Marine Approvals	LRS: 01/00172 (E3), DNV: E-13848, ABS: 14-LD234401A-4-PDA, BV: 43180/A1
Ingress Protection Rating**	IP66, IP67 & IP68***
Cable Gland Material	Brass, Electroless Nickel Plated Brass, Stainless Steel, Aluminium
Seal Material	CMP SOLO LSF Halogen Free Thermoset Elastomer
Cable Type	Unarmoured & Lead Sheathed, Lead Covered
Sealing Technique	CMP Unique Displacement Seal Concept
Sealing Area(s)	Cable Inner Lead Sheath or Lead Covering and Cable Outer Sheath

* Mechanical & Electrical Classifications applied as per IEC 62444 & EN 62444
 ** When CMP installation accessories are used. Refer to page 7 or www.cmp-products.com for further information.
 *** IP68 tested to a minimum depth of 30 metres for 12 hours, alternate depths / durations can be provided upon request

Cable Gland Selection Table

Refer to illustration at the top of the page.

Dimensions listed below are for metric cable glands only
 Dimensions for alternative threads may vary, please see supplementary technical data sheet

Cable Gland Size	Available Entry Threads "C" (Alternate Metric Thread Lengths Available)					Diameter over Lead Sheath "A"		Overall Cable Diameter "B"		Across Flats "D"	Across Corners "D"	Protrusion Length "F"	Combined Ordering Reference (*Brass Metric)			Shroud	Cable Gland Weight (Kgs)
	Standard			Option		Min	Max	Min	Max				Size	Type	Ordering Suffix		
	Metric	Thread Length (Metric)"E"	NPT	Thread Length (NPT)"E"	NPT												
20S16	M20	15.0	1/2"	19.9	3/4"	3.2	7.8	3.2	8.6	24.0	26.4	49.5	20S16	SS2KPB	1RA	PVC04	0.14
20S	M20	15.0	1/2"	19.9	3/4"	6.1	11.0	6.1	11.7	24.0	26.4	49.5	20S	SS2KPB	1RA	PVC04	0.13
20	M20	15.0	1/2"	19.9	3/4"	6.5	13.4	6.5	14.0	27.0	29.7	54.5	20	SS2KPB	1RA	PVC05	0.16
25	M25	15.0	3/4"	20.2	1"	11.1	19.3	11.1	20.0	36.0	39.6	66.5	25	SS2KPB	1RA	PVC09	0.30
32	M32	15.0	1"	25.0	1 1/4"	17.0	25.5	17.0	26.3	41.0	45.1	67.5	32	SS2KPB	1RA	PVC10	0.36
40	M40	15.0	1 1/4"	25.6	1 1/2"	23.5	31.2	23.5	32.1	50.0	55.0	70.5	40	SS2KPB	1RA	PVC13	0.51
50S	M50	15.0	1 1/2"	26.1	2"	31.0	37.2	31.0	38.2	55.0	60.5	65.5	50S	SS2KPB	1RA	PVC15	0.57
50	M50	15.0	2"	26.9	2 1/2"	35.6	42.6	35.6	44.0	60.0	66.0	70.5	50	SS2KPB	1RA	PVC18	0.60
63S	M63	15.0	2"	26.9	2 1/2"	41.5	48.5	41.5	49.9	70.5	77.6	70.5	63S	SS2KPB	1RA	PVC21	0.90
63	M63	15.0	2 1/2"	39.9	3"	47.2	54.2	47.2	55.9	75.0	82.5	71.5	63	SS2KPB	1RA	PVC23	0.86
75S	M75	15.0	2 1/2"	39.9	3"	54.0	60.2	54.0	61.9	80.0	88.0	70.5	75S	SS2KPB	1RA	PVC25	1.03
75	M75	15.0	3"	41.5	3 1/2"	61.1	65.2	61.1	67.9	84.0	92.4	75.5	75	SS2KPB	1RA	PVC26	1.00
90	M90	24.0	3 1/2"	42.8	4"	66.6	77.1	66.6	79.4	108.0	118.8	113.5	90	SS2KPB	1RA	PVC31	3.01
100	M100	24.0	3 1/2"	42.8	4"	76.0	88.1	76.0	90.9	123.0	134.2	106.5	100	SS2KPB	1RA	LSF33	3.41
115	M115	24.0	4"	44.0	5"	86.0	94.1	86.0	97.9	133.4	146.7	128.5	115	SS2KPB	1RA	LSF34	5.35
130	M130	24.0	5"	46.8	-	97.0	110.1	97.0	114.9	152.4	167.6	129.5	130	SS2KPB	1RA	LSF35	6.39

*For material options add the following suffix to the Ordering Reference; Brass (no suffix required), Nickel Plated Brass 'S'; 316 Grade Stainless Steel '4'; Copper Free Aluminium '1'
 For NPT options add the following digits to the material suffix; 1/2" = 31; 3/4" = 32; 1" = 33; 1 1/4" = 34; 1 1/2" = 35; 2" = 36; 2 1/2" = 37; 3" = 38; 3 1/2" = 39; 4" = 310 (Brass requires prefix '0')

Examples: 32SS2KPB1RA534 = Nickel Plated Brass 1 1/4" NPT, 50SS2KPB1RA035 = Brass 1 1/2" NPT, 25SS2KPB1RA432 = Stainless Steel 3/4" NPT, 20SS2KPB1RA5 = Nickel Plated Brass M20

Dimensions are displayed in millimetres unless otherwise stated

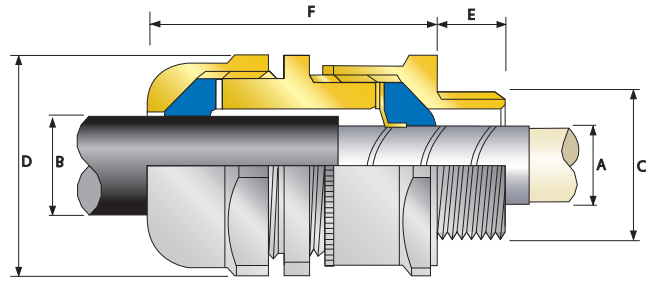

SS2KTA



SS2KTA Double Seal, Ex e, Internationally Approved, Explosive Atmosphere Cable Gland

For all types of Tape Armoured Cables

- Effectively earths / grounds tape armour cables
- Direct & remote installation
- Superior levels of cable retention
- Displacement type flameproof seals
- Secure against self-loosening
- -60°C to +130°C
- Internationally marked, IECEx & ATEX



TECHNICAL DATA	
Design Specification	BS 6121:Part 1:1989, IEC 62444, EN 62444
Mechanical Classifications*	Impact = Level 8, Cable Anchorage = Class B
Enclosure Protection	IK10 to IEC 62262 (20 joules) Brass & Stainless Steel only
ATEX Certificate	SIRA13ATEX1069X, SIRA13ATEX4075X
Code of Protection	II 2G II 1D Ex e IIC Gb, Ex ta IIIC Da II 3G Ex nR IIC Gc
Compliance Standards	EN 60079-0,1,7,15,31
IECEx Certificate	IECEx SIR 13.0024X, IECEx SIM 14.0006
Code of Protection	Ex e IIC Gb, Ex nR IIC Gc, Ex ta IIIC Da
Compliance Standards	IEC 60079-0,1,7,15,31
EAC Certificate	TC RU C-GB.ГБ05.В00138
UkrSEPRO	UA.TR.047.C.0644-15
CCOE / PESO (India) Certificate	P333688
INMETRO Approval	TÜV 12.0879X
Ingress Protection Rating**	IP66, IP67 & IP68***
Cable Gland Material	Brass, Electroless Nickel Plated Brass, Aluminium, Stainless Steel
Seal Material	CMP SOLO LSF Halogen Free Thermoset Elastomer
Cable Type	Steel Tape Armour (STA)
Sealing Technique	CMP Unique Displacement Seal Concept
Sealing Area(s)	Steel Tape Armour and Cable Outer Sheath

* Mechanical & Electrical Classifications applied as per IEC 62444 & EN 62444
 ** When CMP installation accessories are used. Refer to page 7 or www.cmp-products.com for further information.
 *** IP68 tested to a minimum depth of 30 metres for 12 hours, alternate depths / durations can be provided upon request

Cable Gland Selection Table

Refer to illustration at the top of the page.

Dimensions listed below are for metric cable glands only
 Dimensions for alternative threads may vary, please see supplementary technical data sheet

Cable Gland Size	Available Entry Threads "C" (Alternate Metric Thread Lengths Available)					Diameter over Tape Armour "A"		Overall Cable Diameter "B"		Across Flats "D"	Across Corners "D"	Protrusion Length "F"	Combined Ordering Reference (*Brass Metric)			Shroud	Cable Gland Weight (Kgs)
	Standard			Option		Min	Max	Min	Max	Max	Max		Size	Type	Ordering Suffix		
	Metric	Thread Length (Metric) "E"	NPT	Thread Length (NPT) "E"	NPT												
20S16	M20	15.0	1/2"	19.9	3/4"	3.2	7.8	3.2	8.6	24.0	26.4	49.5	20S16	SS2KTA	1RA	PVC04	0.14
20S	M20	15.0	1/2"	19.9	3/4"	6.1	11.0	6.1	11.7	24.0	26.4	49.5	20S	SS2KTA	1RA	PVC04	0.13
20	M20	15.0	1/2"	19.9	3/4"	6.5	13.4	6.5	14.0	27.0	29.7	54.5	20	SS2KTA	1RA	PVC05	0.16
25	M25	15.0	3/4"	20.2	1"	11.1	19.3	11.1	20.0	36.0	39.6	66.5	25	SS2KTA	1RA	PVC09	0.30
32	M32	15.0	1"	25.0	1 1/4"	17.0	25.5	17.0	26.3	41.0	45.1	67.5	32	SS2KTA	1RA	PVC10	0.36
40	M40	15.0	1 1/4"	25.6	1 1/2"	23.5	31.2	23.5	32.1	50.0	55.0	70.5	40	SS2KTA	1RA	PVC13	0.51
50S	M50	15.0	1 1/2"	26.1	2"	31.0	37.2	31.0	38.2	55.0	60.5	65.5	50S	SS2KTA	1RA	PVC15	0.57
50	M50	15.0	2"	26.9	2 1/2"	35.6	42.6	35.6	44.0	60.0	66.0	70.5	50	SS2KTA	1RA	PVC18	0.60
63S	M63	15.0	2"	26.9	2 1/2"	41.5	48.5	41.5	49.9	70.5	77.6	70.5	63S	SS2KTA	1RA	PVC21	0.90
63	M63	15.0	2 1/2"	39.9	3"	47.2	54.2	47.2	55.9	75.0	82.5	71.5	63	SS2KTA	1RA	PVC23	0.86
75S	M75	15.0	2 1/2"	39.9	3"	54.0	60.2	54.0	61.9	80.0	88.0	70.5	75S	SS2KTA	1RA	PVC25	1.03
75	M75	15.0	3"	41.5	3 1/2"	61.1	65.2	61.1	67.9	84.0	92.4	75.5	75	SS2KTA	1RA	PVC26	1.00
90	M90	24.0	3 1/2"	42.8	4"	66.6	77.1	66.6	79.4	108.0	118.8	113.5	90	SS2KTA	1RA	PVC31	3.01
100	M100	24.0	3 1/2"	42.8	4"	76.0	88.1	76.0	90.9	123.0	134.2	106.5	100	SS2KTA	1RA	LSF33	3.41
115	M115	24.0	4"	44.0	5"	86.0	94.1	86.0	97.9	133.4	146.7	128.5	115	SS2KTA	1RA	LSF34	5.35
130	M130	24.0	5"	46.8	-	97.0	110.1	97.0	114.9	152.4	167.6	129.5	130	SS2KTA	1RA	LSF35	6.39

*For material options add the following suffix to the Ordering Reference, Brass (no suffix required), Nickel Plated Brass 'S', 316 Grade Stainless Steel '4', Copper Free Aluminium '1'
 For NPT options add the following digits to the material suffix; 1/2" = 31, 3/4" = 32, 1" = 33, 1 1/4" = 34, 1 1/2" = 35, 2" = 36, 2 1/2" = 37, 3" = 38, 3 1/2" = 39, 4" = 310 (Brass requires prefix '0')

Examples: 32SS2KTA1RA534 = Nickel Plated Brass 1 1/4" NPT, 50SS2KTA1RA035 = Brass 1 1/2" NPT, 25SS2KTA1RA432 = Stainless Steel 3/4" NPT, 20SS2KTA1RA5 = Nickel Plated Brass M20

Dimensions are displayed in millimetres unless otherwise stated

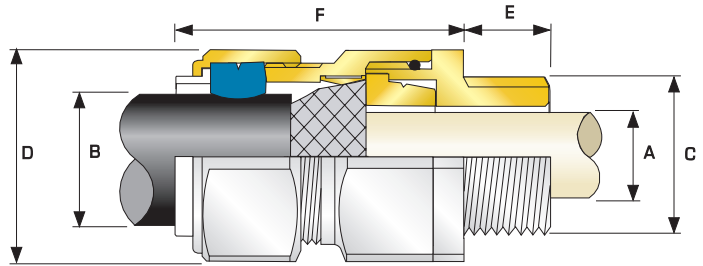
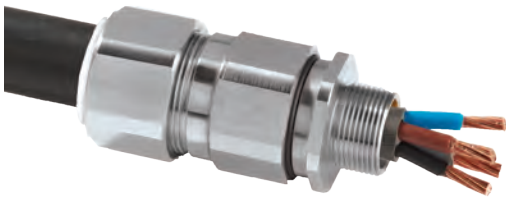

C2K



C2K Internationally Approved, Ex e, Explosive Atmosphere Cable Gland

For all types of Armoured cables

- Metal-to-metal armour clamping
- Direct & remote installation
- Integral protected deluge seal
- Controlled outer 'load retention' seal
- Unique OSTG prevents overtightening
- Integral protected deluge seal
- -60°C to +130°C (standard), -20°C to 200°C (ThermEx option)
- Internationally marked, IECEx & ATEX
- Superior EMC performance



† Grooved Cone (X) is predominantly used for Wire Braid (e.g. GSWB, TCWB), Steel Tape Armour (STA, DSTA) and Aluminium Strip Armour (ASA) but is also suitable for Single Wire Armour (SWA), Aluminium Wire Armour (AWA) and Pliable Wire Armour (PWA) if the range is outside that of the Stepped Cone (W).

Grooved Cone (X) dimensions shown in the Cable Gland Selection Table below are for a double wire strand of braid armour cables. Tapes can also be doubled over. For cables that have only a single layer of armour such as SWA the clamping range should be used as shown in the table below.

Stepped (W) Cone is suitable for Single Wire Armour (SWA), or Aluminium Wire Armour (AWA) cables.

TECHNICAL DATA	
Design Specification	BS 6121:Part 1:1989, IEC 62444, EN 62444
Mechanical Classifications*	Impact = Level 8, Cable Anchorage = Class D
Enclosure Protection	IK10 to IEC 62262 (20 joules) Brass & Stainless Steel only
Electrical Classifications*	Category B (Category A when used with braid, tape or pliable wire armour cables)
ATEX Certificate	SIRA13ATEX1070X
Code of Protection	⊕ II 2G, II 1D, Ex e IIC Gb, Ex ta IIIC Da
Compliance Standards	EN 60079-0,7,31
IECEx Certificate	IECEx SIR 13.0025X
Code of Protection	Ex e IIC Gb, Ex ta IIIC Da
Compliance Standards	IEC 60079-0,7,31
EAC Certificate	TC RU C-GB.ГБ05.В00138
UkrSEPRO	UA.TR.047.C.0644-15
CCOE / PESO (India) Certificate	P333688
NEPSI Certificate	GY13.1140X
INMETRO Approval	TÜV 12.0617X
RETIE Approval Number	03866
Marine Approvals	LRS: 01/00172 (E3) DNV: E-13848 ABS: 16-LD1478091PDA, BV: 43180/A1
Ingress Protection Rating**	IP66, IP67 & IP68***
Deluge Protection Compliance	DTS01 : 91
Cable Gland Material	Brass, Electroless Nickel Plated Brass, Stainless Steel, Aluminium
Seal Material	CMP SOLO LSF Halogen Free Thermoset Elastomer
Cable Type	Single Wire Armour (SWA), Aluminium Wire Armour (AWA), Pliable Wire Armour (PWA), Steel Tape Armour (STA), Wire Braid Armour (e.g. SWB), Aluminium Strip Armour (ASA), Screened Flexible (EMC) Wire Braid (e.g. CY / SY), Armoured & Jacketed
Armour Clamping	Reversible Armour Cone & AnyWay Universal Clamping Ring
Sealing Technique	Unique CMP 'LRS' Outer Seal (Load Retention Seal)
Sealing Area(s)	Cable Outer Sheath

* Mechanical & Electrical Classifications applied as per IEC 62444 & EN 62444
 ** When CMP installation accessories are used. Refer to page 7 or www.cmp-products.com for further information.
 *** IP68 tested to a minimum depth of 30 metres for 12 hours, alternate depths / durations can be provided upon request

Cable Gland Selection Table

Refer to illustration at the top of the page.

Dimensions listed below are for metric cable glands only
 Dimensions for alternative threads may vary, please see supplementary technical data sheet

Cable Gland Size	Available Entry Threads "C" (Alternate Metric Thread Lengths Available)					Cable Bedding Diameter "A"	Overall Cable Diameter "B"		Armour Range †				Across Flats "D"	Across Corners "D"	Protrusion Length "F"	Combined Ordering Reference (*Brass Metric)			Shroud	Cable Gland Weight (Kgs)
	Standard			Option			Min	Max	Grooved Cone (X)		Stepped Cone (W)					Size	Type	Ordering Suffix		
	Metric	Thread Length (Metric) "E"	NPT	Thread Length (NPT) "E"	NPT				Max	Min	Max	Min	Max	Min	Max					
20S16	M20	15.0	1/2"	19.9	3/4"	8.7	6.1	13.1	0.3	1.0	0.8	1.25	30.5	33.6	65.0	20S16	C2K	1RA	PVC04	0.23
20S	M20	15.0	1/2"	19.9	3/4"	11.7	9.5	15.9	0.3	1.0	0.8	1.25	30.5	33.6	62.0	20S	C2K	1RA	PVC04	0.24
20	M20	15.0	1/2"	19.9	3/4"	14.0	12.5	20.9	0.4	1.0	0.8	1.25	30.5	33.6	63.0	20	C2K	1RA	PVC06	0.22
25S	M25	15.0	3/4"	20.2	1"	20.0	14.0	22.0	0.4	1.2	1.25	1.6	37.5	41.3	69.5	25S	C2K	1RA	PVC09	0.35
25	M25	15.0	3/4"	20.2	1"	20.0	18.2	26.2	0.4	1.2	1.25	1.6	37.5	41.3	69.5	25	C2K	1RA	PVC09	0.35
32	M32	15.0	1"	25.0	1 1/4"	26.0	23.7	33.9	0.4	1.2	1.6	2.0	46.0	50.6	75.0	32	C2K	1RA	PVC11	0.55
40	M40	15.0	1 1/4"	25.6	1 1/2"	32.2	27.9	40.4	0.4	1.6	1.6	2.0	55.0	60.5	75.0	40	C2K	1RA	PVC15	0.75
50S	M50	15.0	1 1/2"	26.1	2"	38.2	35.2	46.7	0.4	1.6	2.0	2.5	60.0	66.0	77.0	50S	C2K	1RA	PVC18	0.86
50	M50	15.0	2"	26.9	2 1/2"	44.1	40.4	53.0	0.6	1.6	2.0	2.5	70.1	77.1	77.0	50	C2K	1RA	PVC21	1.13
63S	M63	15.0	2"	26.9	2 1/2"	50.0	45.6	59.4	0.6	1.6	2.0	2.5	75.0	82.5	80.0	63S	C2K	1RA	PVC23	1.35
63	M63	15.0	2 1/2"	39.9	3"	56.0	54.6	65.8	0.6	1.6	2.0	2.5	80.0	88.0	80.0	63	C2K	1RA	PVC25	1.34
75S	M75	15.0	2 1/2"	39.9	3"	62.0	59.0	72.0	0.6	1.6	2.0	2.5	90.0	99.0	87.0	75S	C2K	1RA	PVC28	2.02
75	M75	15.0	3"	41.5	3 1/2"	64.2	66.7	78.4	0.6	1.6	2.5	3.0	100.0	110.0	88.0	75	C2K	1RA	PVC30	2.48
90	M90	24.0	3 1/2"	42.8	4"	78.6	76.2	90.3	0.8	1.6	3.15	4.0	115.0	126.5	102.0	90	C2K	1RA	PVC32	3.52
100	M100	24.0	3 1/2"	42.8	4"	91.0	86.1	101.4	0.8	1.6	3.15	4.0	127.0	139.7	114.0	100	C2K	1RA	LSF33	4.58
115	M115	24.0	4"	44.0	5"	98.0	101.5	110.2	0.8	1.6	3.15	4.0	133.4	146.7	114.0	115	C2K	1RA	LSF34	6.50
130	M130	24.0	5"	46.8	-	115.0	110.2	123.2	0.8	1.6	3.15	4.0	152.4	167.6	114.0	130	C2K	1RA	LSF35	8.50

*For material options add the following suffix to the Ordering Reference; Brass (no suffix required); Nickel Plated Brass 'S'; 316 Grade Stainless Steel '4'; Copper Free Aluminium '1'
 For NPT options add the following digits to the material suffix; 1/2" = 31; 3/4" = 32; 1" = 33; 1 1/4" = 34; 1 1/2" = 35; 2" = 36; 2 1/2" = 37; 3" = 38; 3 1/2" = 39; 4" = 310 (Brass requires prefix '0')

Examples: 32C2K1RA534 = Nickel Plated Brass 1 1/4" NPT, 50S2C2K1RA035 = Brass 1 1/2" NPT, 25C2K1RA432 = Stainless Steel 3/4" NPT, 20C2K1RA5 = Nickel Plated Brass M20

Dimensions are displayed in millimetres unless otherwise stated

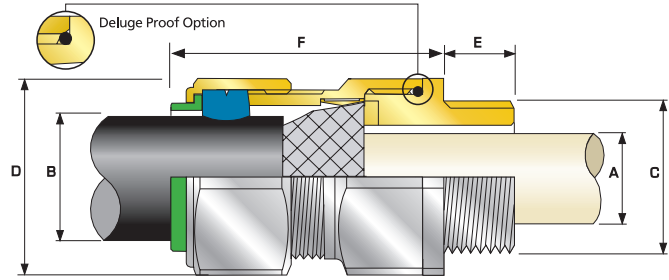
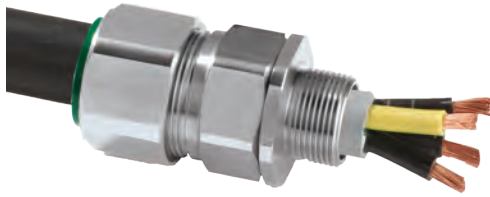

CXe



CXe Internationally Approved, Ex e, Explosive Atmosphere Cable Gland

For Braided & Steel Tape Armoured Cables

- Metal-to-metal armour clamping
- Direct & remote installation
- Permanently crimped, low impedance earth termination
- Secure against self-loosening
- Controlled outer 'load retention' seal
- Unique OSTG prevents overtightening
- -60°C to +130°C
- Internationally marked, IECEx & ATEX
- Superior EMC performance



Deluge Proof version available, ferrule colour coded white for ease of identification, please add "D" after the product type.

† Grooved Cone (X) is predominantly used for Wire Braid (e.g. GSWB, TCWB), Steel Tape Armour (STA, DSTA) and Aluminium Strip Armour (ASA) but is also suitable for Single Wire Armour (SWA), Aluminium Wire Armour (AWA) and Pliable Wire Armour (PWA) if the range is outside that of the Stepped Cone (W).

Grooved Cone (X) dimensions shown in the Cable Gland Selection Table below are for a double wire strand of braid armour cables. Tapes can also be doubled over. For cables that have only a single layer of armour such as SWA the clamping range should be used as shown in the table below.

TECHNICAL DATA	
Design Specification	BS 6121:Part 1:1989, IEC 62444, EN 62444
Mechanical Classifications*	Impact = Level 8, Cable Anchorage = Class D
Enclosure Protection	IK10 to IEC 62262 (20 joules) Brass & Stainless Steel only
Electrical Classifications*	Category B (Category A when used with braid, tape or pliable wire armour cables)
ATEX Certificate	SIRA13ATEX1070X
Code of Protection	Ex II 2G, II 1D, Ex e IIC Gb, Ex ta IIIC Da
Compliance Standards	EN 60079-0,7,31
IECEx Certificate	IECEx SIR 13.0025X
Code of Protection	Ex e IIC Gb, Ex ta IIIC Da
Compliance Standards	IEC 60079-0,7,31
EAC Certificate	TCRU C-GB.F605.B00138
UkrSEPRO	UA.TR.047.C.0644-15
NEPSI Certificate	GY13.1140X
INMETRO Approval	TÜV 12.0617X
CCOE / PESO (India) Certificate	P333688
RETIE Approval Number	03866
Marine Approvals	LRS: 01/00172 (E3) DNV: E-13848 ABS: 16-LD1478091PDA, BV: 43180/A1
Ingress Protection Rating**	IP66 as standard (IP67, IP68*** available upon request)
Cable Gland Material	Brass, Electroless Nickel Plated Brass, Aluminium, Stainless Steel
Seal Material	CMP SOLO LSF Halogen Free Thermoset Elastomer
Cable Type	Wire Braid Armour (e.g. SWB), Screened Flexible (EMC) Wire Braid (e.g. CY / SY), Pliable Wire Armour (PWA), Steel Tape Armour (STA), Strip Armour (e.g. ASA)
Armour Clamping	Detachable Armour Cone & AnyWay Universal Clamping Ring
Sealing Technique	Unique CMP 'LRS' Outer Seal (Load Retention Seal)
Sealing Area(s)	Cable Outer Sheath

* Mechanical & Electrical Classifications applied as per IEC 62444 & EN 62444

** When CMP installation accessories are used. Refer to page 7 or www.cmp-products.com for further information.

*** IP68 tested to a minimum depth of 30 metres for 12 hours, alternate depths / durations can be provided upon request

Cable Gland Selection Table

Refer to illustration at the top of the page.

Cable Gland Size	Available Entry Threads "C"		Cable Bedding Diameter "A"	Overall Cable Diameter "B"			Armour Range † Grooved Cone (X)		Across Flats "D"	Across Corners "D"	Protrusion Length "F"	Combined Ordering Reference (*Brass Metric)			Shroud	Cable Gland Weight (Kgs)
	Metric	Thread Length (Metric) "E"		Max	Min	Max	Min	Max				Size	Type	Ordering Suffix		
20S16	M20	15.0	8.7	6.1	13.1	0.3	1.0	24.0	26.4	48.0	20S16	CXE	1RA	PVC04	0.10	
20S	M20	15.0	11.7	9.5	15.9	0.3	1.0	24.0	26.4	48.0	20S	CXE	1RA	PVC04	0.10	
20	M20	15.0	14.0	12.5	20.9	0.4	1.0	30.5	33.6	48.0	20	CXE	1RA	PVC06	0.15	
25S	M25	15.0	20.0	14.0	22.0	0.4	1.2	37.5	41.3	56.0	25S	CXE	1RA	PVC09	0.22	
25	M25	15.0	20.0	18.2	26.2	0.4	1.2	37.5	41.3	56.0	25	CXE	1RA	PVC09	0.22	
32	M32	15.0	26.0	23.7	33.9	0.4	1.2	46.0	50.6	54.0	32	CXE	1RA	PVC11	0.31	
40	M40	15.0	32.2	27.9	40.4	0.4	1.6	55.0	60.5	58.0	40	CXE	1RA	PVC15	0.45	
50S	M50	15.0	38.2	35.2	46.7	0.4	1.6	60.0	66.0	61.0	50S	CXE	1RA	PVC18	0.57	
50	M50	15.0	44.1	40.4	53.0	0.6	1.6	70.1	77.1	60.0	50	CXE	1RA	PVC21	0.75	
63S	M63	15.0	50.0	45.6	59.4	0.6	1.6	75.0	82.5	74.0	63S	CXE	1RA	PVC23	1.04	
63	M63	15.0	56.0	54.6	65.8	0.6	1.6	80.0	88.0	71.0	63	CXE	1RA	PVC25	1.02	
75S	M75	15.0	62.0	59.0	72.0	0.6	1.6	90.0	99.0	86.0	75S	CXE	1RA	PVC28	1.79	
75	M75	15.0	64.2	66.7	78.4	0.6	1.6	100.0	110.0	82.0	75	CXE	1RA	PVC30	2.09	
90	M90	24.0	78.6	76.2	90.3	0.8	1.6	114.3	125.7	95.0	90	CXE	1RA	PVC32	3.04	
100	M100	24.0	91.0	86.1	101.4	0.8	1.6	123.0	135.3	95.0	100	CXE	1RA	LSF33	3.13	
115	M115	24.0	98.0	101.5	110.2	0.8	1.6	133.4	146.7	107.5	115	CXE	1RA	LSF34	4.48	
130	M130	24.0	115.0	110.2	123.2	0.8	1.6	152.4	167.6	110.0	130	CXE	1RA	LSF35	5.77	

* For material options add the following suffix to the Ordering Reference; Brass (no suffix required); Nickel Plated Brass '5'; 316 Grade Stainless Steel '4'; Copper Free Aluminium '1' For NPT options add the following digits to the material suffix; 1/2" = 31; 3/4" = 32; 1" = 33; 1 1/4" = 34; 1 1/2" = 35; 2" = 36; 2 1/2" = 37; 3" = 38; 3 1/2" = 39; 4" = 310 (Brass requires prefix '0')

Examples: 32CXE1RA534 = Nickel Plated Brass 1 1/4" NPT, 50SCXE1RA035 = Brass 1 1/2" NPT, 25CXE1RA432 = Stainless Steel 3/4" NPT, 20CXE1RA5 = Nickel Plated Brass M20

Dimensions are displayed in millimetres unless otherwise stated

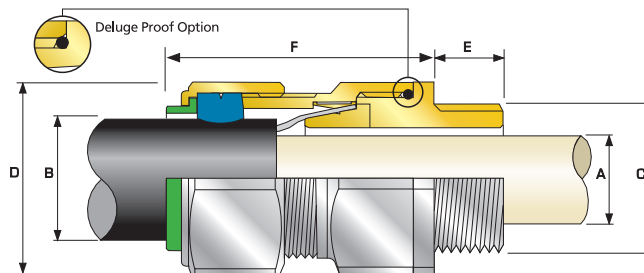
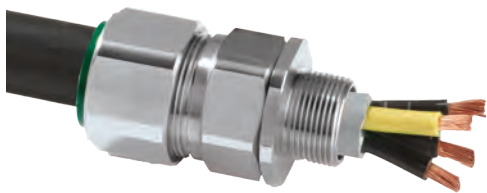

CWe



CWe Internationally Approved, Ex e, Explosive Atmosphere Cable Gland

For all types of Steel & Aluminium Wire Armoured Cables

- Metal-to-metal armour clamping
- Direct & remote installation
- Permanently crimped, low impedance earth termination
- Secure against self-loosening
- Controlled outer 'load retention' seal
- Unique OSTG prevents overtightening
- -60°C to +130°C
- Internationally marked, IECEx & ATEX
- Superior EMC performance



Deluge Proof version available, ferrule colour coded white for ease of identification, please add "D" after the product type.

TECHNICAL DATA	
Design Specification	BS 6121:Part 1:1989, IEC 62444, EN 62444
Mechanical Classifications*	Impact = Level 8, Cable Anchorage = Class D
Enclosure Protection	IK10 to IEC 62262 (20 joules) Brass & Stainless Steel only
Electrical Classifications*	Category B
ATEX Certificate	SIRA13ATEX1070X
Code of Protection	⊕ II 2G, II 1D, Ex e IIC Gb, Ex ta IIIC Da
Compliance Standards	EN 60079-0,7,31
IECEX Certificate	IECEX SIR 13.0025X
Code of Protection	Ex e IIC Gb, Ex ta IIIC Da
Compliance Standards	IEC 60079-0,7,31
EAC Certificate	TC RU C-GB.ГБ05.В00138
UkrSEPRO	UA.TR.047.C.0644-15
NEPSI Certificate	GYJ13.1140X
CCOE / PESO (India) Certificate	P333688
INMETRO Approval	TÜV 12.0617X
RETIE Approval Number	03866
Marine Approvals	LRS: 01/00172 (E3) DNV: E-13848 ABS: 16-LD1478091PDA, BV: 43180/A1
Ingress Protection Rating**	IP66 as standard (IP67, IP68*** available upon request)
Cable Gland Material	Brass, Electroless Nickel Plated Brass, Aluminium, Stainless Steel
Seal Material	CMP SOLO LSF Halogen Free Thermoset Elastomer
Cable Type	Single Wire Armour (SWA), Aluminium Wire Armour (AWA),
Armour Clamping	Detachable Armour Cone & AnyWay Universal Clamping Ring
Sealing Technique	Outer Load Retention Seal (LRS)
Sealing Area(s)	Outer Cable Sheath

* Mechanical & Electrical Classifications applied as per IEC 62444 & EN 62444
 ** When CMP installation accessories are used. Refer to page 7 or www.cmp-products.com for further information.
 *** IP68 tested to a minimum depth of 30 metres for 12 hours, alternate depths / durations can be provided upon request

Cable Gland Selection Table

Refer to illustration at the top of the page.

Cable Gland Size	Metric	Thread Length (Metric) "E"	Cable Bedding Diameter "A"		Overall Cable Diameter "B"		Armour Range		Across Flats "D"	Across Corners "D"	Protrusion Length "F"	Combined Ordering Reference (*Brass Metric)			Shroud	Cable Gland Weight (Kgs)
			Max	Min	Max	Min	Max	Max				Max	Size	Type		
20S16	M20	15.0	8.7	6.1	13.1	0.8	1.25	24.0	26.4	48.0	20S16	CWE	1RA	PVC04	0.10	
20S	M20	15.0	11.7	9.5	15.9	0.8	1.25	24.0	26.4	48.0	20S	CWE	1RA	PVC04	0.10	
20	M20	15.0	14.0	12.5	20.9	0.8	1.25	30.5	33.6	48.0	20	CWE	1RA	PVC06	0.15	
25S	M25	15.0	20.0	14.0	22.0	1.25	1.6	37.5	41.3	56.0	25S	CWE	1RA	PVC09	0.22	
25	M25	15.0	20.0	18.2	26.2	1.25	1.6	37.5	41.3	56.0	25	CWE	1RA	PVC09	0.22	
32	M32	15.0	26.0	23.7	33.9	1.6	2.0	46.0	50.6	54.0	32	CWE	1RA	PVC11	0.31	
40	M40	15.0	32.2	27.9	40.4	1.6	2.0	55.0	60.5	58.0	40	CWE	1RA	PVC15	0.45	
50S	M50	15.0	38.2	35.2	46.7	2.0	2.5	60.0	66.0	61.0	50S	CWE	1RA	PVC18	0.57	
50	M50	15.0	44.1	40.4	53.0	2.0	2.5	70.1	77.1	60.0	50	CWE	1RA	PVC21	0.75	
63S	M63	15.0	50.0	45.6	59.4	2.0	2.5	75.0	82.5	74.0	63S	CWE	1RA	PVC23	1.04	
63	M63	15.0	56.0	54.6	65.8	2.0	2.5	80.0	88.0	71.0	63	CWE	1RA	PVC25	1.02	
75S	M75	15.0	62.0	59.0	72.0	2.0	2.5	90.0	99.0	86.0	75S	CWE	1RA	PVC28	1.79	
75	M75	15.0	64.2	66.7	78.4	2.5	3.0	100.0	110.0	82.0	75	CWE	1RA	PVC30	2.09	
90	M90	24.0	78.6	76.2	90.3	3.15	4.0	114.3	125.7	95.0	90	CWE	1RA	PVC32	3.04	
100	M100	24.0	91.0	86.1	101.4	3.15	4.0	123.0	135.3	95.0	100	CWE	1RA	LSF33	3.13	
115	M115	24.0	98.0	101.5	110.2	3.15	4.0	133.4	146.7	107.5	115	CWE	1RA	LSF34	4.48	
130	M130	24.0	115.0	110.2	123.2	3.15	4.0	152.4	167.6	110.0	130	CWE	1RA	LSF35	5.76	

*For material options add the following suffix to the Ordering Reference; Brass (no suffix required); Nickel Plated Brass 'S'; 316 Grade Stainless Steel '4'; Copper Free Aluminium '1'
 For NPT options add the following digits to the material suffix; 1/2" = 31; 3/4" = 32; 1" = 33; 1 1/4" = 34; 1 1/2" = 35; 2" = 36; 2 1/2" = 37; 3" = 38; 3 1/2" = 39; 4" = 310 (Brass requires prefix '0')

Examples: 32CWE1RA534 = Nickel Plated Brass 1 1/4" NPT, 50SCWE1RA035 = Brass 1 1/2" NPT, 25CWE1RA432 = Stainless Steel 3/4" NPT, 20CWE1RA5 = Nickel Plated Brass M20

Dimensions are displayed in millimetres unless otherwise stated

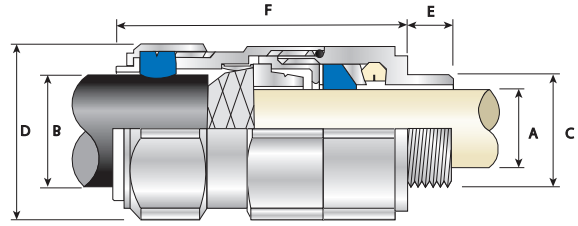

TE1FU Ex e Ex d Ex nR Ex ta

TE1FU Globally Approved, Explosive Atmosphere Cable Gland

For all types of Armoured Cables

- Stainless steel compact design
- Fully sequential, three step installation procedure
- Reduces installation times, cost & risk
- Direct & remote installation
- Unique compensating displacement seal system(CDS)
- Metal-to-metal installation regardless of cable bedding diameter
- Integral protected deluge seal
- Controlled outer 'load retention' seal
- Unique OSTG prevents overtightening
- -60°C to +130°C
- Globally marked, IECEx, ATEX & cCSAus
- Superior EMC performance



† Grooved Cone (X) is predominantly used for Wire Braid (e.g. GSWB, TCWB), Steel Tape Armour (STA, DSTA) and Aluminium Strip Armour (ASA) but is also suitable for Single Wire Armour (SWA), Aluminium Wire Armour (AWA) and Pliable Wire Armour (PWA) if the range is outside that of the Stepped Cone (W).

Grooved Cone (X) dimensions shown in the Cable Gland Selection Table below are for a double wire strand of braid armoured cables. Tapes can also be doubled over. For cables that have only a single layer of armour such as SWA the clamping range should be used as shown in the table below.

Stepped (W) Cone is suitable for Single Wire Armour (SWA), or Aluminium Wire Armour (AWA) cables.

TECHNICAL DATA	
Design Specification	BS 6121:Part 1:1989, IEC 62444, EN 62444
Mechanical Classifications*	Impact = Level 8, Cable Anchorage = Class D
Enclosure Protection	IK10 to IEC 62262 (20 joules) Brass & Stainless Steel only
Electrical Classifications*	Category B (Category A when used with braid, tape or pliable wire armour cables)
ATEX Certificate	SIRA13ATEX1073X, SIRA13ATEX4079X
Code of Protection	Ⓜ II 2G, II 1D, Ex d IIC Gb, Ex e IIC Gb, Ex ta IIIC Da, Ⓜ II 3G Ex nR IIC Gc, Ⓜ I M2, Ex d I Mb, Ex e I Mb
Compliance Standards	EN60079-0,1,7,15,31
IECEx Certificate	IECEx SIR 13.0028X, IECEx SIM 14.0007X
Code of Protection	Ex d IIC Gb, Ex e IIC Gb, Ex nR IIC Gc, Ex ta IIIC Da, Ex d I Mb, Ex e I Mb
Compliance Standards	IEC 60079-0,1,7,15,31
cCSAus Certificate (20S16 - 90)	1310517
CSAus Code of Protection	Class I, Div 2, Groups A,B,C and D, Class II, Div 2, Groups E,F and G, Class III, Enclosure Type 3, 4 and 4X, Class I, Zone 1, AEx e II, AEx nR II
cCSA Code of Protection	Class I, Div 2, Groups A,B,C and D, Class II, Div 2, Groups E,F and G, Class III, Enclosure Type 3, 4 and 4X, Ex d IIC, Ex e IIC, Ex nR II
Compliance Standards	CAN/CSA-C22.2 No 0, 18, 25, 30, 94, 174, CAN/CSA-E60079-0, 1, 7, ANSI/UL 514B Ed 5, ANSI/UL 50 Ed 11, ANSI/UL 2225 Ed 4, UL60079-0, 1, 7
EAC Certificate	TC RU C-Gb, ГБ05.800138
NEPSI Certificate	GYJ13.1141X / GYJ13.1283X
CCOE / PESO (India) Certificate	P333688
INMETRO Approval	TÜV 11.0374X
RETIE Approval Number	03866
Marine Approvals	LRS: 01/00172 (E3), DNV: E-13848, ABS: 14-LD234401A4-PDA, BV: 43180/A1
Ingress Protection Rating**	IP66, IP67 & IP68***
Deluge Protection Compliance	DTS01 : 91
Cable Gland Material	Stainless Steel
Seal Material	CMP SOLO LSF Halogen Free Thermoset Elastomer
Cable Type(s)	Single Wire Armour (SWA), Aluminium Wire Armour (AWA), Pliable Wire Armour (PWA), Steel Tape Armour (STA), Aluminium Strip Armour (ASA), Screened Flexible (EMC) Wire Braid (e.g CY/SY), Wire Braid Armour (e.g SWB)
Armour Clamping	Reversible Armour Cone & AnyWay Universal Clamping Ring
Sealing Technique	Inner Bedding Sealing Ring: Compensating Displacement Seal (CDS), Outer Sheath Sealing Ring : Load Retention Seal (LRS)
Sealing Area(s)	Cable Inner Bedding & Outer Cable Sheath

* Mechanical & Electrical Classifications applied as per IEC 62444 & EN 62444
 ** When CMP installation accessories are used. Refer to page 7 or www.cmp-products.com for further information.
 *** IP68 tested to a minimum depth of 30 metres for 12 hours, alternate depths / durations can be provided upon request

Cable Gland Selection Table

Refer to illustration at the top of the page.

Dimensions listed below are for metric cable glands only
 Dimensions for alternative threads may vary, please see supplementary technical data sheet

Cable Gland Size	Available Entry Threads "C" (Alternate Metric Thread Lengths Available)				Cable Bedding Diameter "A"		Overall Cable Diameter "B"		Armour Range †			Across Flats "D"	Across Corners "D"	Protrusion Length "F"	Combined Ordering Reference (Stainless Steel Metric)			Shroud	Cable Gland Weight (Kgs)		
	Standard		Option		Min	Max	Min	Max	Grooved Cone (X)	Stepped Cone (W)	Max	Max	Size		Type	Ordering Suffix					
	Metric	Thread Length (Metric) "E"	NPT	Thread Length (NPT) "E"													NPT				
20S16	M20	15.0	1/2"	19.9	3/4"	3.1	8.6	6.1	13.1	0.3	1.0	0.8	1.25	24.0	26.4	57.3	20S16	TE1FU	1RA4	PVC04	0.15
20S	M20	15.0	1/2"	19.9	3/4"	6.1	11.6	9.5	15.9	0.3	1.0	0.8	1.25	24.0	26.4	57.3	20S	TE1FU	1RA4	PVC04	0.15
20	M20	15.0	1/2"	19.9	3/4"	6.5	13.9	12.5	20.9	0.4	1.0	0.8	1.25	30.5	33.6	61.2	20	TE1FU	1RA4	PVC06	0.23
25S	M25	15.0	3/4"	20.2	1"	11.1	19.9	14.0	22.0	0.4	1.2	1.25	1.6	37.5	41.3	74.0	25S	TE1FU	1RA4	PVC09	0.34
25	M25	15.0	3/4"	20.2	1"	11.1	19.9	18.2	26.2	0.4	1.2	1.25	1.6	37.5	41.3	74.0	25	TE1FU	1RA4	PVC09	0.34
32	M32	15.0	1"	25.0	1 1/4"	17.0	26.2	23.7	33.9	0.4	1.2	1.6	2.0	46.0	50.6	78.2	32	TE1FU	1RA4	PVC11	0.55
40	M40	15.0	1 1/4"	25.6	1 1/2"	22.0	32.1	27.9	40.4	0.4	1.6	1.6	2.0	55.0	60.5	81.6	40	TE1FU	1RA4	PVC15	0.79
50S	M50	15.0	1 1/2"	26.1	2"	29.5	38.1	35.2	46.7	0.4	1.6	2.0	2.5	60.0	66.0	88.1	50S	TE1FU	1RA4	PVC18	1.00
50	M50	15.0	2"	26.9	2 1/2"	35.6	44.0	40.4	53.0	0.6	1.6	2.0	2.5	70.1	77.1	91.2	50	TE1FU	1RA4	PVC21	1.37
63S	M63	15.0	2"	26.9	2 1/2"	40.1	49.9	45.6	59.4	0.6	1.6	2.0	2.5	75.0	82.4	90.5	63S	TE1FU	1RA4	PVC23	1.50
63	M63	15.0	2 1/2"	39.9	3"	47.2	55.9	54.6	65.8	0.6	1.6	2.0	2.5	80.0	88.0	90.3	63	TE1FU	1RA4	PVC25	1.56
75S	M75	15.0	2 1/2"	39.9	3"	52.8	61.9	59.0	72.0	0.6	1.6	2.0	2.5	90.0	99.0	104.7	75S	TE1FU	1RA4	PVC28	2.45
75	M75	15.0	3"	41.5	3 1/2"	59.1	67.9	66.7	78.4	0.6	1.6	2.5	3.0	100.0	110.0	110.8	75	TE1FU	1RA4	PVC30	3.15
90	M90	24.0	3 1/2"	42.8	4"	66.6	78.6	76.2	90.3	0.8	1.6	3.15	4.0	115.0	126.5	135.5	90	TE1FU	1RA4	PVC32	4.62
100	M100	24.0	3 1/2"	42.8	4"	76.0	90.9	86.1	101.4	0.8	1.6	3.15	4.0	127.0	139.7	126.8	100	TE1FU	1RA4	LSF34	4.95
115	M115	24.0	4"	44.0	5"	86.0	97.9	101.5	110.2	0.8	1.6	3.15	4.0	138.0	151.8	157.5	115	TE1FU	1RA4	LSF34	7.60
130	M130	24.0	5"	46.8	-	97.0	114.9	110.2	123.2	0.8	1.6	3.15	4.0	157.0	172.7	164.5	130	TE1FU	1RA4	LSF35	8.73

For NPT options add the following digits to the material suffix; 1/2" = 31; 3/4" = 32; 1" = 33; 1 1/4" = 34; 1 1/2" = 35; 2" = 36; 2 1/2" = 37; 3" = 38; 3 1/2" = 39; 4" = 310 (Brass requires prefix '0')

Examples: 32TE1FU1RA434 = Stainless Steel 1 1/4" NPT, 50STE1FU1RA435 = 1 1/2" NPT, 25TE1FU1RA432 = Stainless Steel 3/4" NPT

Dimensions are displayed in millimetres unless otherwise stated

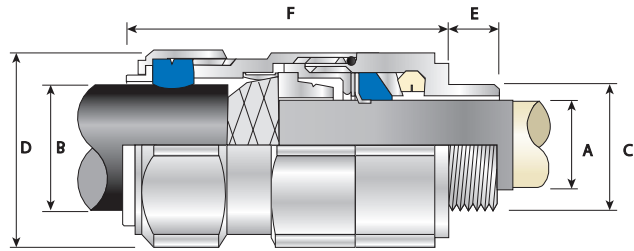

TE1FUPB

TE1FUPB Globally Approved, Explosive Atmosphere Cable Gland

For all types of Lead Sheathed Armoured Cables

- Stainless steel compact design
- Effectively earths / grounds lead sheathed cables
- Fully sequential, three step installation procedure
- Reduces installation times, cost & risk
- Direct & remote installation
- Unique compensating displacement seal system(CDS)
- Metal-to-metal installation regardless of lead sheath diameter
- Integral protected deluge seal
- Controlled outer 'load retention' seal
- Unique OSTG prevents overtightening
- -60°C to +130°C
- Globally marked, IECEx, ATEX & cCSAus
- Superior EMC performance



† Grooved Cone (X) is predominantly used for Wire Braid (e.g. GSWB, TCWB), Steel Tape Armour (STA, DSTA) and Aluminium Strip Armour (ASA) but is also suitable for Single Wire Armour (SWA), Aluminium Wire Armour (AWA) and Pliable Wire Armour (PWA) if the range is outside that of the Stepped Cone (W).

Grooved Cone (X) dimensions shown in the Cable Gland Selection Table below are for a double wire strand of braid armoured cables. Tapes can also be doubled over. For cables that have only a single layer of armour such as SWA the clamping range should be used as shown in the table below.

Stepped (W) Cone is suitable for Single Wire Armour (SWA), or Aluminium Wire Armour (AWA) cables.

TECHNICAL DATA

Design Specification	BS 6121:Part 1:1989, IEC 62444, EN 62444
Mechanical Classifications*	Impact = Level 8, Cable Anchorage = Class D
Enclosure Protection	IK10 to IEC 62262 (20 joules) Brass & Stainless Steel only
Electrical Classifications*	Category B (Category A when used with braid, tape or pliable wire armour cables)
ATEX Certificate	SIRA13ATEX1073X, SIRA13ATEX4079X
Code of Protection	⊕ II 2G, II 1D, Ex d IIC Gb, Ex e IIC Gb, Ex ta IIIC Da, ⊕ II 3G Ex nR IIC Gc, I M2, Ex d I Mb, Ex e I Mb
Compliance Standards	EN60079-0,1,7,15,31
IECEx Certificate	IECEx SIR 13.0028X, IECEx SIM 14.0007X
Code of Protection	Ex d IIC Gb, Ex e IIC Gb, Ex nR IIC Gc, Ex ta IIIC Da, Ex d I Mb, Ex e I Mb
Compliance Standards	IEC 60079-0,1,7,15,31
cCSAus Certificate (20S16 - 90)	1310517
CSAus Code of Protection	Class I, Div 2, Groups A,B,C and D, Class II, Div 2, Groups E,F and G, Class III, Enclosure Type 3, 4 and 4X, Class I, Zone 1, AEx e II, AEx nR II
cCSA Code of Protection	Class I, Div 2, Groups A,B,C and D, Class II, Div 2, Groups E,F and G, Class III, Enclosure Type 3, 4 and 4X, Ex d IIC, Ex e IIC, Ex nR II
Compliance Standards	CAN/CSA-C22.2 No 0, 18, 25, 30, 94, 174, CAN/CSA-E60079-0, 1, 7, ANSI/UL 514B Ed 5, ANSI/UL 50 Ed 11, ANSI/UL 2225 Ed 4, UL60079-0, 1, 7
EAC Certificate	TC RU C-GB, ГБ05.B.00138
NEPSI Certificate	GYJ13.1141X / GYJ13.1283X
CCOE / PESO (India) Certificate	P333688
INMETRO Approval	TÜV 11.0374X
Ingress Protection Rating**	IP66, IP67 & IP68***
Deluge Protection Compliance	DTS01 : 91
Cable Gland Material	Stainless Steel
Seal Material	CMP SOLO LSF Halogen Free Thermoset Elastomer
Cable Type(s)	Lead Sheathed & Single Wire Armour (LC/SWA), Lead Sheathed & Aluminium Wire Armour (LC/AWA), Lead Sheathed & Wire Braid Armour (LC/SWB), Lead Sheathed & Pliable Wire Armour (LC/PWA), Lead Sheathed & Steel Tape Armour (LC/STA), Lead Sheathed & Aluminium Strip Armour (LC/ASA)
Armour Clamping	Reversible Armour Cone & AnyWay Universal Clamping Ring
Sealing Technique	Inner Bedding Sealing Ring: Compensating Displacement Seal (CDS), Outer Sheath Sealing Ring : Load Retention Seal (LRS)
Sealing Area(s)	Cable Inner Bedding & Outer Cable Sheath

* Mechanical & Electrical Classifications applied as per IEC 62444 & EN 62444

** When CMP installation accessories are used. Refer to page 7 or www.cmp-products.com for further information.

*** IP68 tested to a minimum depth of 30 metres for 12 hours, alternate depths / durations can be provided upon request

Cable Gland Selection Table

Refer to illustration at the top of the page.

Cable Gland Size	Available Entry Threads "C" (Alternate Metric Thread Lengths Available)					Lead Sheath Diameter "A"		Overall Cable Diameter "B"		Armour Range †				Across Flats "D"	Across Corners "D"	Protrusion Length "F"	Combined Ordering Reference (Stainless Steel Metric)			Shroud	Cable Gland Weight (Kgs)
	Standard			Option		Min	Max	Min	Max	Grooved Cone (X)		Max	Max	Size	Type		Ordering Suffix				
	Metric	Thread Length (Metric) "E"	NPT	Thread Length (NPT) "E"	NPT					Grooved Cone (X)	Stepped Cone (W)										
20S16	M20	15.0	1/2"	19.9	3/4"	3.1	7.8	6.1	13.1	0.3	1.0	0.8	1.25	24.0	26.4	57.3	20S16	TE1FUPB	1RA4	PVC04	0.15
20S	M20	15.0	1/2"	19.9	3/4"	6.1	11.0	9.5	15.9	0.3	1.0	0.8	1.25	24.0	26.4	57.3	20S	TE1FUPB	1RA4	PVC04	0.15
20	M20	15.0	1/2"	19.9	3/4"	6.5	13.4	12.5	20.9	0.4	1.0	0.8	1.25	30.5	33.6	61.2	20	TE1FUPB	1RA4	PVC06	0.23
25S	M25	15.0	3/4"	20.2	1"	11.1	19.3	14.0	22.0	0.4	1.2	1.25	1.6	37.5	41.3	74.0	25S	TE1FUPB	1RA4	PVC09	0.35
25	M25	15.0	3/4"	20.2	1"	11.1	19.3	18.2	26.2	0.4	1.2	1.25	1.6	37.5	41.3	74.0	25	TE1FUPB	1RA4	PVC09	0.35
32	M32	15.0	1"	25.0	1 1/4"	17.0	25.5	23.7	33.9	0.4	1.2	1.6	2.0	46.0	50.6	78.2	32	TE1FUPB	1RA4	PVC11	0.55
40	M40	15.0	1 1/4"	25.6	1 1/2"	22.0	31.2	27.9	40.4	0.4	1.6	1.6	2.0	55.0	60.5	81.6	40	TE1FUPB	1RA4	PVC15	0.80
50S	M50	15.0	1 1/2"	26.1	2"	29.5	37.2	35.2	46.7	0.4	1.6	2.0	2.5	60.0	66.0	88.1	50S	TE1FUPB	1RA4	PVC18	1.01
50	M50	15.0	2"	26.9	2 1/2"	35.6	42.6	40.4	53.0	0.6	1.6	2.0	2.5	70.1	77.1	91.2	50	TE1FUPB	1RA4	PVC21	1.38
63S	M63	15.0	2"	26.9	2 1/2"	40.1	48.5	45.6	59.4	0.6	1.6	2.0	2.5	75.0	82.4	90.5	63S	TE1FUPB	1RA4	PVC23	1.51
63	M63	15.0	2 1/2"	39.9	3"	47.2	54.2	54.6	65.8	0.6	1.6	2.0	2.5	80.0	88.0	104.3	63	TE1FUPB	1RA4	PVC25	1.57
75S	M75	15.0	2 1/2"	39.9	3"	52.8	60.2	59.0	72.0	0.6	1.6	2.0	2.5	90.0	99.0	104.7	75S	TE1FUPB	1RA4	PVC28	2.46
75	M75	15.0	3"	41.5	3 1/2"	59.1	65.2	66.7	78.4	0.6	1.6	2.5	3.0	100.0	110.0	110.8	75	TE1FUPB	1RA4	PVC30	3.15
90	M90	24.0	3 1/2"	42.8	4"	66.6	77.1	76.2	90.3	0.8	1.6	3.15	4.0	115.0	126.5	135.5	90	TE1FUPB	1RA4	PVC32	4.63
100	M100	24.0	4"	44.0	5"	76.0	88.1	86.1	101.4	0.8	1.6	3.15	4.0	127.0	139.7	126.8	100	TE1FUPB	1RA4	LSF33	4.97
115	M115	24.0	4"	44.0	5"	86.0	94.1	101.5	110.2	0.8	1.6	3.15	4.0	138.0	151.8	157.5	115	TE1FUPB	1RA4	LSF34	7.60
130	M130	24.0	5"	46.8	6"	97.0	110.1	110.2	123.2	0.8	1.6	3.15	4.0	157.0	172.7	164.5	130	TE1FUPB	1RA4	LSF35	8.77

For NPT options add the following digits to the material suffix; 1/2" = 31; 3/4" = 32; 1" = 33; 1 1/4" = 34; 1 1/2" = 35; 2" = 36; 2 1/2" = 37; 3" = 38; 3 1/2" = 39; 4" = 310 (Brass requires prefix '0')

Examples: 32TE1FUPB1RA434 = Stainless Steel 1 1/4" NPT, 50STE1FUPB1RA435 = 1 1/2" NPT, 25TE1FUPB1RA432 = Stainless Steel 3/4" NPT

Dimensions are displayed in millimetres unless otherwise stated

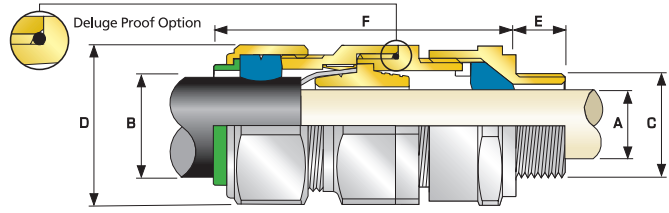

E1FU Ex e Exd ExnR Exta

E1FU Globally Approved, Explosive Atmosphere Cable Gland

For all types of Armoured cables

- Metal-to-metal armour clamping
- Direct & remote installation
- Displacement type flameproof inner seal
- Controlled outer 'load retention' seal
- Unique OSTG prevents overtightening
- -60°C to +130°C
- Globally marked, IECEx, ATEX & cCSAus
- Superior EMC performance



† Grooved Cone (X) is predominantly used for Wire Braid (e.g. GSWB, TCWB), Steel Tape Armour (STA, DSTA) and Aluminium Strip Armour (ASA) but is also suitable for Single Wire Armour (SWA), Aluminium Wire Armour (AWA) and Pliable Wire Armour (PWA) if the range is outside that of the Stepped Cone (W).

Grooved Cone (X) dimensions shown in the Cable Gland Selection Table below are for a double wire strand of braid armour cables. Tapes can also be doubled over. For cables that have only a single layer of armour such as SWA the clamping range should be used as shown in the table below.

Stepped (W) Cone is suitable for Single Wire Armour (SWA), or Aluminium Wire Armour (AWA) cables.

TECHNICAL DATA	
Design Specification	BS 6121:Part 1:1989, IEC 62444, EN 62444
Mechanical Classifications*	Impact = Level 8, Cable Anchorage = Class D
Enclosure Protection	IK10 to IEC 62262 (20 joules) Brass & Stainless Steel only
Electrical Classifications*	Category B (Category A when used with braid, tape or pliable wire armour cables)
ATEX Certificate	SIRA13ATEX1071X, SIRA13ATEX4077X
Code of Protection	Ⓜ II 2G, II 1D, Ex d IIC Gb, Ex e IIC Gb, Ex ta IIIC Da Ⓜ II 3G Ex nR IIC Gc, Ⓜ IM2 Ex d I Mb, Ex e I Mb
Compliance Standards	EN 60079-0,1,7,15,31
IECEx Certificate	IECEx SIR 13.0026X, IECEx SIM 14.0007X
Code of Protection	Ex d IIC Gb, Ex e IIC Gb, Ex nR IIC Gc, Ex ta IIIC Da, Ex d I Mb, Ex e I Mb
Compliance Standards	IEC 60079-0,1,7,15,31
cCSAus Certificate (20S16 - 90)	1310517
CSAus Code of Protection	Class I, Div 2, Groups A,B,C and D, Class II, Div 2, Groups E,F and G, Class III, Enclosure Type 3, 4 and 4X, Class I, Zone 1, AEx e II, AEx nR II
cCSA Code of Protection	Class I, Div 2, Groups A,B,C and D, Class II, Div 2, Groups E,F and G, Class III, Enclosure Type 3, 4 and 4X, Ex d IIC, Ex e IIC, Ex nR II
Compliance Standards	CAN/CSA-C22.2 No 0, 18, 25, 30, 94, 174, CAN/CSA-E60079-0, 1, 7, ANSI/UL 514B Ed 5, ANSI/UL 50 Ed 11, ANSI/UL 2225 Ed 4, UL60079-0, 1, 7
EAC Certificate (Formerly GOST R & K)	TC RU C-GB.ГБ05.В00138
UkrSEPRO	UA.TR.047.C.0644-15
KCS Certificate	14-64B0-0257X
NEPSI Certificate	GYJ13.1140X / GYJ13.1282X
CCOE / PESO (India) Certificate	P333688
INMETRO Approval	TÜV 12.0618X
RETIE Approval Number	03866
Marine Approvals	LRS: 01/00172 (E3), DNV: E-13848, ABS: 14-LD234401A-4-PDA, BV: 43180/A1
Ingress Protection Rating**	IP66 as standard (IP67, IP68*** available upon request)
Deluge Protection Compliance	DTS01:91 option available on request (white ferrule for identification purposes)
Cable Gland Material	Brass, Electroless Nickel Plated Brass, Aluminium
Seal Material	CMP SOLO LSF Halogen Free Thermoset Elastomer
Cable Type	Single Wire Armour (SWA), Aluminium Wire Armour (AWA), Steel Tape Armour (STA), Wire Braid Armour (e.g. SWB), Aluminium Strip Armour (ASA), Pliable Wire Armour (PWA), Screened Flexible (EMC) Wire Braid (e.g. CY / SY), Armoured & Jacketed
Armour Clamping	Reversible Armour Cone & AnyWay Universal Clamping Ring
Sealing Technique	CMP Inner Displacement Seal & Unique CMP 'LRS'™ Outer Load Retention Seal
Sealing Area(s)	Cable Inner Bedding & Outer Cable Sheath

* Mechanical & Electrical Classifications applied as per IEC 62444 & EN 62444
 ** When CMP installation accessories are used. Refer to page 7 or www.cmp-products.com for further information.
 *** IP68 tested to a minimum depth of 30 metres for 12 hours, alternate depths / durations can be provided upon request

Cable Gland Selection Table

Refer to illustration at the top of the page.

Dimensions listed below are for metric cable glands only
 Dimensions for alternative threads may vary, please see supplementary technical data sheet

Cable Gland Size	Available Entry Threads "C" (Alternate Metric Thread Lengths Available)					Cable Bedding Diameter "A"		Overall Cable Diameter "B"		Armour Range †				Across Flats "D"	Across Corners "D"	Protrusion Length "F"	Combined Ordering Reference (*Brass Metric)			Shroud	Cable Gland Weight (Kgs)
	Standard			Option		Min	Max	Min	Max	Grooved Cone (X)		Stepped Cone (W)					Size	Type	Ordering Suffix		
	Metric	Thread Length (Metric) "E"	NPT	Thread Length (NPT) "E"	NPT	Min	Max	Min	Max	Min	Max	Min	Max	Max	Max						
20S16	M20	15.0	1/2"	19.9	3/4"	3.1	8.6	6.1	13.1	0.3	1.0	0.8	1.25	24.0	26.4	72.5	20S16	E1FU	1RA	PVC04	0.16
20S	M20	15.0	1/2"	19.9	3/4"	6.1	11.6	9.5	15.9	0.3	1.0	0.8	1.25	24.0	26.4	70.0	20S	E1FU	1RA	PVC04	0.15
20	M20	15.0	1/2"	19.9	3/4"	6.5	13.9	12.5	20.9	0.4	1.0	0.8	1.25	30.5	33.6	73.0	20	E1FU	1RA	PVC06	0.21
25S	M25	15.0	3/4"	20.2	1"	11.1	19.9	14.0	22.0	0.4	1.2	1.25	1.6	37.5	41.3	89.0	25S	E1FU	1RA	PVC09	0.33
25	M25	15.0	3/4"	20.2	1"	11.1	19.9	18.2	26.2	0.4	1.2	1.25	1.6	37.5	41.3	89.0	25	E1FU	1RA	PVC09	0.33
32	M32	15.0	1"	25.0	1 1/4"	17.0	26.2	23.7	33.9	0.4	1.2	1.6	2.0	46.0	50.6	86.0	32	E1FU	1RA	PVC11	0.43
40	M40	15.0	1 1/4"	25.6	1 1/2"	22.0	32.1	27.9	40.4	0.4	1.6	1.6	2.0	55.0	60.5	90.0	40	E1FU	1RA	PVC15	0.62
50S	M50	15.0	1 1/2"	26.1	2"	29.5	38.1	35.2	46.7	0.4	1.6	2.0	2.5	60.0	66.0	91.0	50S	E1FU	1RA	PVC18	0.75
50	M50	15.0	2"	26.9	2 1/2"	35.6	44.0	40.4	53.0	0.6	1.6	2.0	2.5	70.1	77.1	95.0	50	E1FU	1RA	PVC21	0.95
63S	M63	15.0	2"	26.9	2 1/2"	40.1	49.9	45.6	59.4	0.6	1.6	2.0	2.5	75.0	82.5	102.0	63S	E1FU	1RA	PVC23	1.34
63	M63	15.0	2 1/2"	39.9	3"	47.2	55.9	54.6	65.8	0.6	1.6	2.0	2.5	80.0	88.0	104.0	63	E1FU	1RA	PVC25	1.34
75S	M75	15.0	2 1/2"	39.9	3"	52.8	61.9	59.0	72.0	0.6	1.6	2.0	2.5	90.0	99.0	115.0	75S	E1FU	1RA	PVC28	2.11
75	M75	15.0	3"	41.5	3 1/2"	59.1	67.9	66.7	78.4	0.6	1.6	2.5	3.0	100.0	110.0	117.0	75	E1FU	1RA	PVC30	2.42
90	M90	24.0	3 1/2"	42.8	4"	66.6	78.6	76.2	90.3	0.8	1.6	3.15	4.0	114.3	125.4	147.0	90	E1FU	1RA	PVC32	4.21
100	M100	24.0	3 1/2"	42.8	4"	76.0	90.9	86.1	101.4	0.8	1.6	3.15	4.0	123.0	135.3	140.0	100	E1FU	1RA	LSF33	4.45
115	M115	24.0	4"	44.0	5"	86.0	97.9	101.5	110.2	0.8	1.6	3.15	4.0	133.4	146.7	162.0	115	E1FU	1RA	LSF34	6.19
130	M130	24.0	5"	46.8	-	97.0	114.9	110.2	123.2	0.8	1.6	3.15	4.0	152.4	167.6	174.0	130	E1FU	1RA	LSF35	8.34

*Note : For material options please add the following suffix to change the Ordering Reference ; Brass (no suffix required), Nickel Plated Brass "5", Copper Free Aluminium "1"
 For NPT options add the following digits to the material suffix; 1/2" = 31; 3/4" = 32; 1" = 33; 1 1/4" = 34; 1 1/2" = 35; 2" = 36; 2 1/2" = 37; 3" = 38; 3 1/2" = 39; 4" = 310 (Brass requires prefix '0')
 Examples: 32E1FU1RA534 = Nickel Plated Brass 1 1/4" NPT, 50SE1FU1RA035 = Brass 1 1/2" NPT, 20E1FU1RA5 = Nickel Plated Brass M20
 Dimensions are displayed in millimetres unless otherwise stated

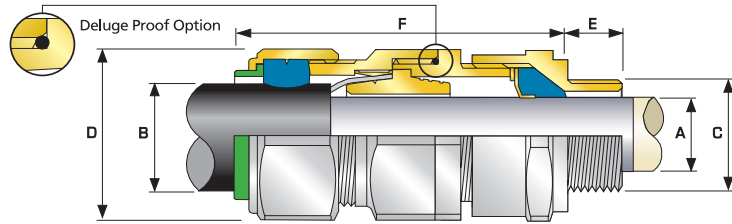

E2FU



E2FU Globally Approved, Explosive Atmosphere Cable Gland

For all types of Lead Sheathed Armoured cables

- Effectively earths / grounds lead sheathed cables
- Metal-to-metal armour clamping
- Direct & remote installation
- Displacement type flameproof inner seal
- Controlled outer 'load retention' seal
- Unique OSTG prevents overtightening
- 60°C to +130°C
- Globally marked, IECEx, ATEX & cCSAus
- Superior EMC performance



† Grooved Cone (X) is predominantly used for Wire Braid (e.g. GSWB, TCWB), Steel Tape Armour (STA, DSTA) and Aluminium Strip Armour (ASA) but is also suitable for Single Wire Armour (SWA), Aluminium Wire Armour (AWA) and Pliable Wire Armour (PWA) if the range is outside that of the Stepped Cone (W).

Grooved Cone (X) dimensions shown in the Cable Gland Selection Table below are for a double wire strand of braid armour cables. Tapes can also be doubled over. For cables that have only a single layer of armour such as SWA the clamping range should be used as shown in the table below.

Stepped (W) Cone is suitable for Single Wire Armour (SWA), or Aluminium Wire Armour (AWA) cables.

TECHNICAL DATA

Design Specification	BS 6121:Part 1:1989, IEC 62444, EN 62444
Mechanical Classifications*	Impact = Level 8, Cable Anchorage = Class D
Enclosure Protection	IK10 to IEC 62262 (20 joules) Brass & Stainless Steel only
Electrical Classifications*	Category B (Category A when used with braid, tape or pliable wire armour cables)
ATEX Certificate	SIRA13ATEX1071X, SIRA13ATEX4077X
Code of Protection	⊕ II 2G, II 1D, Ex d IIC Gb, Ex e IIC Gb, Ex ta IIIC Da ⊕ II 3G Ex nR IIC Gc, ⊕ IM2 Ex d I Mb, Ex e I Mb
Compliance Standards	EN 60079-0,1,7,15,31
IECEx Certificate	IECEx SIR 13.0026X, IECEx SIM 14.0007X
Code of Protection	Ex d IIC Gb, Ex e IIC Gb, Ex nR IIC Gc, Ex ta IIIC Da, Ex d I Mb, Ex e I Mb
Compliance Standards	IEC 60079-0,1,7,15,31
cCSAus Certificate (20S16 - 90)	1310517
CSAus Code of Protection	Class I, Div 2, Groups A,B,C and D, Class II, Div 2, Groups E,F and G, Class III, Enclosure Type 3, 4 and 4X, Class I, Zone 1, AEx e II, AEx nR II
cCSA Code of Protection	Class I, Div 2, Groups A,B,C and D, Class II, Div 2, Groups E,F and G, Class III, Enclosure Type 3, 4 and 4X, Ex d IIC, Ex e IIC, Ex nR II
Compliance Standards	CAN/CSA-C22.2 No 0, 18, 25, 30, 94, 174, CAN/CSA-E60079-0, 1, 7, ANSI/UL 514B Ed 5, ANSI/UL 50 Ed 11, ANSI/UL 2225 Ed 4, UL60079-0, 1, 7 TC RU C-GB.F505.B00138
EAC Certificate	
UkrSEPRO	UA.TR.047.C.0644-15
KCS Certificate	14-GA4BO-0257X
NEPSI Certificate	GYJ13.1140X / GYJ13.1282X
CCOE / PESO (India) Certificate	P333688
INMETRO Approval	TUV 12.0618X
RETIE Approval Number	03866
Marine Approvals	LRS: 01/00172 (E3), DNV: E-13848, ABS: 14-LD234401A-4-PDA, BV: 43180/A1
Ingress Protection Rating**	IP66 as standard (IP67, IP68*** available upon request)
Deluge Protection Compliance	DTS01:91 option available on request (white ferrule for identification purposes)
Cable Gland Material	Brass, Electroless Nickel Plated Brass, Aluminium
Seal Material	CMP SOLO LSF Halogen Free Thermoset Elastomer
Cable Type	Lead Sheathed & Single Wire Armour (LC/SWA), Lead Sheathed & Aluminium Wire Armour (LC/AWA), Lead Sheathed & Wire Braid Armour (LC/SWB), Lead Sheathed & Pliable Wire Armour (LC/PWA), Lead Sheathed & Steel Tape Armour (LC/STA), Lead Sheathed & Aluminium Strip Armour (LC/ASA)
Armour Clamping	Reversible Armour Cone & AnyWay Universal Clamping Ring
Sealing Technique	CMP Inner Displacement Seal & Unique CMP 'LRS'™ Outer Load Retention Seal
Sealing Area(s)	Cable Inner Bedding & Outer Cable Sheath

* Mechanical & Electrical Classifications applied as per IEC 62444 & EN 62444

** When CMP installation accessories are used. Refer to page 7 or www.cmp-products.com for further information.

*** IP68 tested to a minimum depth of 30 metres for 12 hours, alternate depths / durations can be provided upon request

Cable Gland Selection Table

Refer to illustration at the top of the page.

Dimensions listed below are for metric cable glands only
Dimensions for alternative threads may vary, please see supplementary technical data sheet

Cable Gland Size	Available Entry Threads "C" (Alternate Metric Thread Lengths Available)					Lead Sheath Diameter "A"		Overall Cable Diameter "B"		Armour Range †				Across Flats "D"	Across Corners "D"	Protrusion Length "F"	Combined Ordering Reference (*Brass Metric)			Shroud	Cable Gland Weight (Kgs)
	Standard			Option		Min	Max	Min	Max	Grooved Cone (X)		Stepped Cone (W)					Size	Type	Ordering Suffix		
	Metric	Thread Length (Metric) "E"	NPT	Thread Length (NPT) "E"	NPT					Min	Max	Min	Max	Min	Max	Min				Max	
20S16	M20	15.0	1/2"	19.9	3/4"	3.1	7.8	6.1	13.1	0.3	1.0	0.8	1.25	24.0	26.4	72.5	20S16	E2FU	1RA	PVC04	0.16
20S	M20	15.0	1/2"	19.9	3/4"	6.1	11.0	9.5	15.9	0.3	1.0	0.8	1.25	24.0	26.4	70.0	20S	E2FU	1RA	PVC04	0.15
20	M20	15.0	1/2"	19.9	3/4"	6.5	13.4	12.5	20.9	0.4	1.0	0.8	1.25	30.5	33.6	73.0	20	E2FU	1RA	PVC06	0.21
25S	M25	15.0	3/4"	20.2	1"	11.1	19.3	14.0	22.0	0.4	1.2	1.25	1.6	37.5	41.3	89.0	25S	E2FU	1RA	PVC09	0.33
25	M25	15.0	3/4"	20.2	1"	11.1	19.3	18.2	26.2	0.4	1.2	1.25	1.6	37.5	41.3	89.0	25	E2FU	1RA	PVC09	0.33
32	M32	15.0	1"	25.0	1 1/4"	17.0	25.5	23.7	33.9	0.4	1.2	1.6	2.0	46.0	50.6	86.0	32	E2FU	1RA	PVC11	0.43
40	M40	15.0	1 1/4"	25.6	1 1/2"	22.0	31.2	27.9	40.4	0.4	1.6	1.6	2.0	55.0	60.5	90.0	40	E2FU	1RA	PVC15	0.63
50S	M50	15.0	1 1/2"	26.1	2"	29.5	37.2	35.2	46.7	0.4	1.6	2.0	2.5	60.0	66.0	91.0	50S	E2FU	1RA	PVC18	0.76
50	M50	15.0	2"	26.9	2 1/2"	35.6	42.6	40.4	53.0	0.6	1.6	2.0	2.5	70.1	77.1	95.0	50	E2FU	1RA	PVC21	0.95
63S	M63	15.0	2"	26.9	2 1/2"	40.1	48.5	45.6	59.4	0.6	1.6	2.0	2.5	75.0	82.5	102.0	63S	E2FU	1RA	PVC23	1.35
63	M63	15.0	2 1/2"	39.9	3"	47.2	54.2	54.6	65.8	0.6	1.6	2.0	2.5	80.0	88.0	104.0	63	E2FU	1RA	PVC25	1.35
75S	M75	15.0	2 1/2"	39.9	3"	52.8	60.2	59.0	72.0	0.6	1.6	2.0	2.5	90.0	99.0	115.0	75S	E2FU	1RA	PVC28	2.12
75	M75	15.0	3"	41.5	3 1/2"	59.1	65.2	66.7	78.4	0.6	1.6	2.5	3.0	100.0	110.0	117.0	75	E2FU	1RA	PVC30	2.43
90	M90	24.0	3 1/2"	42.8	4"	66.6	77.1	76.2	90.3	0.8	1.6	3.15	4.0	114.3	125.4	147.0	90	E2FU	1RA	PVC32	4.23
100	M100	24.0	3 1/2"	42.8	4"	76.0	88.1	86.1	101.4	0.8	1.6	3.15	4.0	123.0	135.3	140.0	100	E2FU	1RA	LSF33	4.47
115	M115	24.0	4"	44.0	5"	86.0	94.1	101.5	110.2	0.8	1.6	3.15	4.0	133.4	146.7	162.0	115	E2FU	1RA	LSF34	6.22
130	M130	24.0	5"	46.8	-	97.0	110.1	110.2	123.2	0.8	1.6	3.15	4.0	152.4	167.6	174.0	130	E2FU	1RA	LSF35	8.38

*Note : For material options please add the following suffix to change the Ordering Reference ; Brass (no suffix required), Nickel Plated Brass "5", Copper Free Aluminium "1"
For NPT options add the following digits to the material suffix; 1/2" = 31; 3/4" = 32; 1" = 33; 1 1/4" = 34; 1 1/2" = 35; 2" = 36; 2 1/2" = 37; 3" = 38; 3 1/2" = 39; 4" = 310 (Brass requires prefix '0')

Examples: 32E2FU1RA534 = Nickel Plated Brass 1 1/4" NPT, 50SE2FU1RA035 = Brass 1 1/2" NPT, 20E2FU1RA5 = Nickel Plated Brass M20

Dimensions are displayed in millimetres unless otherwise stated

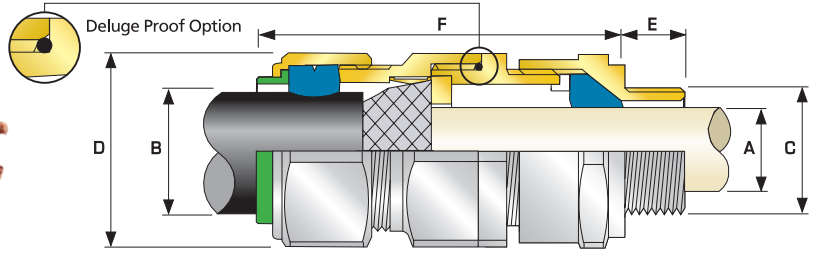

E1FX



E1FX Internationally Approved, Explosive Atmosphere Cable Gland

For Braided & Steel Tape Armoured Cables

- Metal-to-metal armour clamping
- Direct & remote installation
- Displacement type flameproof inner seal
- Controlled outer 'load retention' seal
- Unique OSTG prevents overtightening
- -60°C to +130°C
- Globally marked, IECEx, ATEX & cCSAus
- Superior EMC performance



† Grooved Cone (X) is predominantly used for Wire Braid (e.g. GSWB, TCWB), Steel Tape Armour (STA, DSTA) and Aluminium Strip Armour (ASA) but is also suitable for Single Wire Armour (SWA), Aluminium Wire Armour (AWA) and Pliable Wire Armour (PWA) if the range is outside that of the Stepped Cone (W).

Grooved Cone (X) dimensions shown in the Cable Gland Selection Table below are for a double wire strand of braid armour cables. Tapes can also be doubled over. For cables that have only a single layer of armour such as SWA the clamping range should be used as shown in the table below.

TECHNICAL DATA	
Design Specification	B5 6121:Part 1:1989, IEC 62444, EN 62444
Mechanical Classifications*	Impact = Level 8, Cable Anchorage = Class B
Enclosure Protection	IK10 to IEC 62262 (20 joules) Brass & Stainless Steel only
Electrical Classifications*	Category B (Category A when used with braid, tape or pliable wire armour cables)
ATEX Certificate	SIRA13ATEX1071X, SIRA13ATEX4077X
Code of Protection	Ⓜ II 2G, II 1D, Ex d IIC Gb, Ex e IIC Gb, Ex ta IIIC Da, Ⓜ II 3G Ex nR IIC Gc, Ⓜ IM2 Ex d I Mb, Ex e I Mb
Compliance Standards	EN 60079-0,1,7,15,31
IECEx Certificate	IECEx SIR 13.0026X, IECEx SIM 14.0007X
Code of Protection	Ex d IIC Gb, Ex e IIC Gb, Ex nR IIC Gc, Ex ta IIIC Da, Ex d I Mb, Ex e I Mb
Compliance Standards	IEC 60079-0,1,7,15,31
cCSAus Certificate (20S16 - 90)	1310517
CSAus Code of Protection	Class I, Div 2, Groups A,B,C and D, Class II, Div 2, Groups E,F and G, Class III, Enclosure Type 3, 4 and 4X, Class I, Zone 1, AEx e II, AEx nR II
cCSA Code of Protection	Class I, Div 2, Groups A,B,C and D, Class II, Div 2, Groups E,F and G, Class III, Enclosure Type 3, 4 and 4X, Ex d IIC, Ex e IIC, Ex nR II
Compliance Standards	CAN/CSA-C22.2 No 0, 18, 25, 30, 94, 174, CAN/CSA-E60079-0, 1, 7, ANSI/UL 514B Ed 5, ANSI/UL 50 Ed 11, ANSI/UL 2225 Ed 4, UL60079-0, 1, 7
EAC Certificate	TC RU C-GB.Г605.В00138
UkrSEPRO	UA.TR.047.C.0644-15
KCS Certificate	14-GA4B0-0257X
CCOE / PESO (India) Certificate	P333688
NEPSI Certificate	GYJ13.1140X / GYJ13.1282X
INMETRO Approval	TÜV 12.0618X
RETIE Approval Number	03866
Marine Approvals	LRS: 01/00172 (E3), DNV: E-13848, ABS: 14-LD234401A-4-PDA, BV: 43180/A1
Ingress Protection Rating**	IP66 as standard (IP67, IP68*** available upon request)
Deluge Protection Compliance	DTSO1:91 option available on request (white ferrule for identification purposes)
Cable Gland Material	Brass, Electroless Nickel Plated Brass, Aluminium
Seal Material	CMP SOLO LSF Halogen Free Thermoset Elastomer
Cable Type	Screened Flexible (EMC) Wire Braid (e.g. CY / SY), Pliable Wire Armour (PWA), Steel Tape Armour (STA), Wire Braid Armour (e.g. SWB), Aluminium Strip Armour (ASA), Armoured & Jacketed
Armour Clamping	Detachable Armour Cone & AnyWay Universal Clamping Ring
Sealing Technique	CMP Inner Displacement Seal & Unique CMP 'LRS'™ Outer Load Retention Seal
Sealing Area(s)	Cable Inner Bedding & Outer Cable Sheath

* Mechanical & Electrical Classifications applied as per IEC 62444 & EN 62444

** When CMP installation accessories are used. Refer to page 7 or www.cmp-products.com for further information.

*** IP68 tested to a minimum depth of 30 metres for 12 hours, alternate depths / durations can be provided upon request

Cable Gland Selection Table

Refer to illustration at the top of the page.

Dimensions listed below are for metric cable glands only
Dimensions for alternative threads may vary, please see supplementary technical data sheet

Cable Gland Size	Available Entry Threads "C" (Alternate Metric Thread Lengths Available)					Cable Bedding Diameter "A"		Overall Cable Diameter "B"		Armour Range † Grooved Cone (X)		Across Flats "D"	Across Corners "D"	Protrusion Length "F"	Combined Ordering Reference (*Brass Metric)			Shroud	Cable Gland Weight (Kgs)
	Standard			Option		Min	Max	Min	Max	Min	Max				Max	Max	Size		
	Metric	Thread Length (Metric) "E"	NPT	Thread Length (NPT) "E"	NPT	Min	Max	Min	Max	Min	Max	Max	Max						
20S16	M20	15.0	½"	19.9	¾"	3.1	8.6	6.1	13.1	0.3	1.0	24.0	26.4	72.5	20S16	E1FX	1RA	PVC04	0.16
20S	M20	15.0	½"	19.9	¾"	6.1	11.6	9.5	15.9	0.3	1.0	24.0	26.4	70.0	20S	E1FX	1RA	PVC04	0.15
20	M20	15.0	½"	19.9	¾"	6.5	13.9	12.5	20.9	0.4	1.0	30.5	33.6	73.0	20	E1FX	1RA	PVC06	0.21
25S	M25	15.0	¾"	20.2	1"	11.1	19.9	14.0	22.0	0.4	1.2	37.5	41.3	89.0	25S	E1FX	1RA	PVC09	0.33
25	M25	15.0	¾"	20.2	1"	11.1	19.9	18.2	26.2	0.4	1.2	37.5	41.3	89.0	25	E1FX	1RA	PVC09	0.33
32	M32	15.0	1"	25.0	1 ¼"	17.0	26.2	23.7	33.9	0.4	1.2	46.0	50.6	86.0	32	E1FX	1RA	PVC11	0.43
40	M40	15.0	1 ¼"	25.6	1 ½"	22.0	32.1	27.9	40.4	0.4	1.6	55.0	60.5	90.0	40	E1FX	1RA	PVC15	0.62
50S	M50	15.0	1 ½"	26.1	2"	29.5	38.1	35.2	46.7	0.4	1.6	60.0	66.0	91.0	50S	E1FX	1RA	PVC18	0.75
50	M50	15.0	2"	26.9	2 ½"	35.6	44.0	40.4	53.0	0.6	1.6	70.1	77.1	95.0	50	E1FX	1RA	PVC21	0.95
63S	M63	15.0	2"	26.9	2 ½"	40.1	49.9	45.6	59.4	0.6	1.6	75.0	82.5	102.0	63S	E1FX	1RA	PVC23	1.34
63	M63	15.0	2 ½"	39.9	3"	47.2	55.9	54.6	65.8	0.6	1.6	80.0	88.0	104.0	63	E1FX	1RA	PVC25	1.34
75S	M75	15.0	2 ½"	39.9	3"	52.8	61.9	59.0	72.0	0.6	1.6	90.0	99.0	115.0	75S	E1FX	1RA	PVC28	2.11
75	M75	15.0	3"	41.5	3 ½"	59.1	67.9	66.7	78.4	0.6	1.6	100.0	110.0	117.0	75	E1FX	1RA	PVC30	2.42
90	M90	24.0	3 ½"	42.8	4"	66.6	78.6	76.2	90.3	0.8	1.6	114.3	125.4	147.0	90	E1FX	1RA	PVC32	4.21
100	M100	24.0	3 ½"	42.8	4"	76.0	90.9	86.1	101.4	0.8	1.6	123.0	135.3	140.0	100	E1FX	1RA	LSF33	4.45
115	M115	24.0	4"	44.0	5"	86.0	97.9	101.5	110.2	0.8	1.6	133.4	146.7	162.0	115	E1FX	1RA	LSF34	6.19
130	M130	24.0	5"	46.8	-	97.0	114.9	110.2	123.2	0.8	1.6	152.4	167.6	174.0	130	E1FX	1RA	LSF35	8.34

*Note: For material options please add the following suffix to change the Ordering Reference : Brass (no suffix required), Nickel Plated Brass "5", Copper Free Aluminium "1"
For NPT options add the following digits to the material suffix; ½" = 31; ¾" = 32; 1" = 33; 1 ¼" = 34; 1 ½" = 35; 2" = 36; 2 ½" = 37; 3" = 38; 3 ½" = 39; 4" = 310 (Brass requires prefix '0')

Examples: 32E1FX1RA534 = Nickel Plated Brass 1 ¼" NPT, 50SE1FX1RA035 = Brass 1 ½" NPT, 20E1FX1RA5 = Nickel Plated Brass M20

Dimensions are displayed in millimetres unless otherwise stated

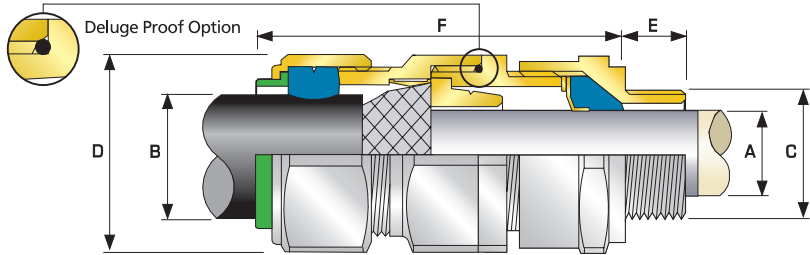

E2FX



E2FX Internationally Approved, Explosive Atmosphere Cable Gland

For Lead Sheathed Braided & Steel Tape Armoured cables

- Effectively earths / grounds lead sheathed cables
- Metal-to-metal armour clamping
- Direct & remote installation
- Displacement type flameproof inner seal
- Controlled outer 'load retention' seal
- Unique OSTG prevents overtightening
- -60°C to +130°C
- Globally marked, IECEx, ATEX & cCSAus
- Superior EMC performance



† Grooved Cone (X) is predominantly used for Wire Braid (e.g. GSWB, TCWB), Steel Tape Armour (STA, DSTA) and Aluminium Strip Armour (ASA) but is also suitable for Single Wire Armour (SWA), Aluminium Wire Armour (AWA) and Pliable Wire Armour (PWA) if the range is outside that of the Stepped Cone (W).

Grooved Cone (X) dimensions shown in the Cable Gland Selection Table below are for a double wire strand of braid armour cables. Tapes can also be doubled over. For cables that have only a single layer of armour such as SWA the clamping range should be used as shown in the table below.

TECHNICAL DATA

Design Specification	BS 6121:Part 1:1989, IEC 62444, EN 62444
Mechanical Classifications*	Impact = Level 8, Cable Anchorage = Class B
Enclosure Protection	IK10 to IEC 62262 (20 joules) Brass & Stainless Steel only
Electrical Classifications*	Category B (Category A when used with braid, tape or pliable wire armour cables)
ATEX Certificate	SIRA13ATEX1071X, SIRA13ATEX4077X
Code of Protection	⊕ II 2G, II 1D, Ex d IIC Gb, Ex e IIC Gb, Ex ta IIIC Da ⊕ II 3G Ex nR IIC Gc, ⊕ IM2 Ex d I Mb, Ex e I Mb
Compliance Standards	EN 60079-0,1,7,15,31
IECEx Certificate	IECEx SIR 13.0026X, IECEx SIM 14.0007X
Code of Protection	Ex d IIC Gb, Ex e IIC Gb, Ex nR IIC Gc, Ex ta IIIC Da, Ex d I Mb, Ex e I Mb
Compliance Standards	IEC 60079-0,1,7,15,31
cCSAus Certificate (20S16 - 90)	1310517
CSAus Code of Protection	Class I, Div 2, Groups A,B,C and D, Class II, Div 2, Groups E,F and G, Class III, Enclosure Type 3, 4 and 4X, Class I, Zone 1, AEx e II, AEx nR II
cCSA Code of Protection	Class I, Div 2, Groups A,B,C and D, Class II, Div 2, Groups E,F and G, Class III, Enclosure Type 3, 4 and 4X, Ex d IIC, Ex e IIC, Ex nR II
Compliance Standards	CAN/CSA-C22.2 No 0, 18, 25, 30, 94, 174, CAN/CSA-E60079-0, 1, 7, ANSI/UL 514B Ed 5, ANSI/UL 50 Ed 11, ANSI/UL 2225 Ed 4, UL60079-0, 1, 7 TC RU C-GB.T605.B00138
EAC Certificate	TC RU C-GB.T605.B00138
UkrSEPRO	UA.TR.047.C.0644-15
KCS Certificate	14-GA4B0-0257X
CCOE / PESO (India) Certificate	P333688
NEPSI Certificate	GYJ13.1140X / GYJ13.1282X
INMETRO Approval	TUV 12.0618X
RETIE Approval Number	03866
Marine Approvals	LRs: 01/00172 (E3), DNV: E-13848, ABS: 14-LD234401A-4-PDA, BV: 43180/A1
Ingress Protection Rating**	IP66 as standard (IP67, IP68*** available upon request)
Deluge Protection Compliance	DTSO1:91 option available on request (white ferrule for identification purposes)
Cable Gland Material	Brass, Electroless Nickel Plated Brass, Aluminium
Seal Material	CMP SOLO LSF Halogen Free Thermoset Elastomer
Cable Type	Lead Sheathed & Wire Braid Armour (LC/SWB), Lead Sheathed & Pliable Wire Armour (LC/PWA), Lead Sheathed & Steel Tape Armour (LC/STA), Lead Sheathed & Strip Armour (LC/ASA)
Armour Clamping	Detachable Armour Cone & AnyWay Universal Clamping Ring
Sealing Technique	CMP Inner Displacement Seal & Unique CMP 'LRS'™ Outer Load Retention Seal
Sealing Area(s)	Cable Inner Bedding & Outer Cable Sheath

* Mechanical & Electrical Classifications applied as per IEC 62444 & EN 62444

** When CMP installation accessories are used. Refer to page 7 or www.cmp-products.com for further information.

*** IP68 tested to a minimum depth of 30 metres for 12 hours, alternate depths / durations can be provided upon request

Cable Gland Selection Table

Refer to illustration at the top of the page.

Dimensions listed below are for metric cable glands only
Dimensions for alternative threads may vary, please see supplementary technical data sheet

Cable Gland Size	Available Entry Threads "C" (Alternate Metric Thread Lengths Available)					Lead Sheath Diameter "A"		Overall Cable Diameter "B"		Armour Range † Grooved Cone (X)		Across Flats "D"		Across Corners "D"		Protrusion Length "E"	Combined Ordering Reference (*Brass Metric)			Shroud	Cable Gland Weight (Kgs)
	Standard			Option		Min	Max	Min	Max	Min	Max	Max	Max	Size	Type		Ordering Suffix				
	Metric	Thread Length (Metric) "E"	NPT	Thread Length (NPT) "E"	NPT																
20S16	M20	15.0	1/2"	19.9	3/4"	3.1	7.8	6.1	13.1	0.3	1.0	24.0	26.4	72.5	20S16	E2FX	1RA	PVC04	0.16		
20S	M20	15.0	1/2"	19.9	3/4"	6.1	11.0	9.5	15.9	0.3	1.0	24.0	26.4	70.0	20S	E2FX	1RA	PVC04	0.15		
20	M20	15.0	1/2"	19.9	3/4"	6.5	13.4	12.5	20.9	0.4	1.0	30.5	33.6	73.0	20	E2FX	1RA	PVC06	0.21		
25S	M25	15.0	3/4"	20.2	1"	11.1	19.3	14.0	22.0	0.4	1.2	37.5	41.3	89.0	25S	E2FX	1RA	PVC09	0.33		
25	M25	15.0	3/4"	20.2	1"	11.1	19.3	18.2	26.2	0.4	1.2	37.5	41.3	89.0	25	E2FX	1RA	PVC09	0.33		
32	M32	15.0	1"	25.0	1 1/4"	17.0	25.5	23.7	33.9	0.4	1.2	46.0	50.6	86.0	32	E2FX	1RA	PVC11	0.43		
40	M40	15.0	1 1/4"	25.6	1 1/2"	22.0	31.2	27.9	40.4	0.4	1.6	55.0	60.5	90.0	40	E2FX	1RA	PVC15	0.63		
50S	M50	15.0	1 1/2"	26.1	2"	29.5	37.2	35.2	46.7	0.4	1.6	60.0	66.0	91.0	50S	E2FX	1RA	PVC18	0.76		
50	M50	15.0	2"	26.9	2 1/2"	35.6	42.6	40.4	53.0	0.6	1.6	70.1	77.1	95.0	50	E2FX	1RA	PVC21	0.95		
63S	M63	15.0	2"	26.9	2 1/2"	40.1	48.5	45.6	59.4	0.6	1.6	75.0	82.5	102.0	63S	E2FX	1RA	PVC23	1.35		
63	M63	15.0	2 1/2"	39.9	3"	47.2	54.2	54.6	65.8	0.6	1.6	80.0	88.0	104.0	63	E2FX	1RA	PVC25	1.95		
75S	M75	15.0	2 1/2"	39.9	3"	52.8	60.2	59.0	72.0	0.6	1.6	90.0	99.0	115.0	75S	E2FX	1RA	PVC28	2.12		
75	M75	15.0	3"	41.5	3 1/2"	59.1	65.2	66.7	78.4	0.6	1.6	100.0	110.0	117.0	75	E2FX	1RA	PVC30	2.43		
90	M90	24.0	3 1/2"	42.8	4"	66.6	77.1	76.2	90.3	0.8	1.6	114.3	125.4	147.0	90	E2FX	1RA	PVC32	4.23		
100	M100	24.0	3 1/2"	42.8	4"	76.0	88.1	86.1	101.4	0.8	1.6	123.0	135.3	140.0	100	E2FX	1RA	LSF33	4.47		
115	M115	24.0	4"	44.0	5"	86.0	94.1	101.5	110.2	0.8	1.6	133.4	146.7	162.0	115	E2FX	1RA	LSF34	6.22		
130	M130	24.0	5"	46.8	-	97.0	110.1	110.2	123.2	0.8	1.6	152.4	167.6	174.0	130	E2FX	1RA	LSF35	8.38		

Note : For material options please add the following suffix to change the Ordering Reference : Brass (no suffix required), Nickel Plated Brass "S", Copper Free Aluminium "1"
For NPT options add the following digits to the material suffix; 1/2" = 31; 3/4" = 32; 1" = 33; 1 1/4" = 34; 1 1/2" = 35; 2" = 36; 2 1/2" = 37; 3" = 38; 3 1/2" = 39; 4" = 310 (Brass requires prefix '0')

Examples: 32E2FX1RA534 = Nickel Plated Brass 1 1/4" NPT, 50SE2FX1RA035 = Brass 1 1/2" NPT, 20E2FX1RA5 = Nickel Plated Brass M20

Dimensions are displayed in millimetres unless otherwise stated

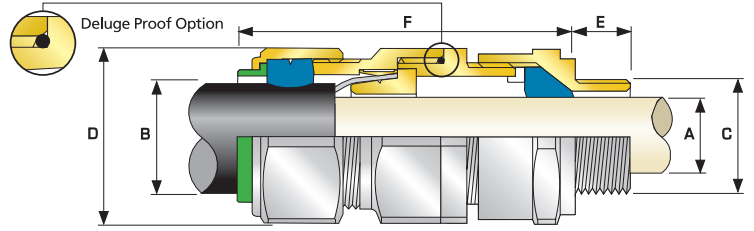

E1FW



E1FW Globally Approved, Explosive Atmosphere Cable Gland

For all types of Steel & Aluminium Wire Armoured Cables

- Metal-to-metal armour clamping
- Direct & remote installation
- Displacement type flameproof inner seal
- Controlled outer 'load retention' seal
- Unique OSTG prevents overtightening
- -60°C to +130°C
- Globally marked, IECEx, ATEX & cCSAus
- Superior EMC performance



TECHNICAL DATA	
Design Specification	BS 6121:Part 1:1989, IEC 62444, EN 62444
Mechanical Classifications*	Impact = Level 8, Cable Anchorage = Class D
Enclosure Protection	IK10 to IEC 62262 (20 joules) Brass & Stainless Steel only
Electrical Classifications*	Category B
ATEX Certificate	SIRA13ATEX1071X, SIRA13ATEX4077X
Code of Protection	Ⓜ II 2G, II 1D, Ex d IIC Gb, Ex e IIC Gb, Ex ta IIIC Da Ⓜ II 3G Ex nR IIC Gc, Ⓜ IM2 Ex d I Mb, Ex e I Mb
Compliance Standards	EN 60079-0,1,7,15,31
IECEx Certificate	IECEx SIR 13.0026X, IECEx SIM 14.0007X
Code of Protection	Ex d IIC Gb, Ex e IIC Gb, Ex nR IIC Gc, Ex ta IIIC Da, Ex d I Mb, Ex e I Mb
Compliance Standards	IEC 60079-0,1,7,15,31
cCSAus Certificate (20S16 - 90)	1310517
CSAus Code of Protection	Class I, Div 2, Groups A,B,C and D, Class II, Div 2, Groups E,F and G, Class III, Enclosure Type 3, 4 and 4X, Class I, Zone 1, AEx e II, AEx nR II
cCSA Code of Protection	Class I, Div 2, Groups A,B,C and D, Class II, Div 2, Groups E,F and G, Class III, Enclosure Type 3, 4 and 4X, Ex d IIC, Ex e IIC, Ex nR II
Compliance Standards	CAN/CSA-C22.2 No 0, 18, 25, 30, 94, 174, CAN/CSA-E60079-0, 1, 7, ANSI/UL 514B Ed 5, ANSI/UL 50 Ed 11, ANSI/UL 2225 Ed 4, UL60079-0, 1, 7
EAC Certificate	TC RU C-GB.ГБ05.В00138
UkrSEPRO	UA.TR.047.C.0644-15
KCS Certificate	14-GA480-0257X
CCOE / PESO (India) Certificate	P333688
NEPSI Certificate	GYJ13.1140X / GYJ13.1282X
INMETRO Approval	TÜV 12.0618X
RETIE Approval Number	03866
Marine Approvals	LRS: 01/00172 (E3), DNV: E-13848, ABS: 14-LD234401A-4-PDA, BV: 43180/A1
Ingress Protection Rating**	IP66 as standard (IP67, IP68*** available upon request)
Deluge Protection Compliance	DT501:91 option available on request (white ferrule for identification purposes)
Cable Gland Material	Brass, Electroless Nickel Plated Brass, Aluminium
Seal Material	CMP SOLO LSF Halogen Free Thermoset Elastomer
Cable Type	Single Wire Armour (SWA), Aluminium Wire Armour (AWA)
Armour Clamping	Detachable Armour Cone & AnyWay Universal Clamping Ring
Sealing Technique	CMP Inner Displacement Seal & Unique CMP 'LRS'™ Outer Load Retention Seal
Sealing Area(s)	Cable Inner Bedding & Outer Cable Sheath

* Mechanical & Electrical Classifications applied as per IEC 62444 & EN 62444
 ** When CMP installation accessories are used. Refer to page 7 or www.cmp-products.com for further information.
 *** IP68 tested to a minimum depth of 30 metres for 12 hours, alternate depths / durations can be provided upon request

Cable Gland Selection Table

Refer to illustration at the top of the page.

Dimensions listed below are for metric cable glands only
 Dimensions for alternative threads may vary, please see supplementary technical data sheet

Cable Gland Size	Available Entry Threads "C" (Alternate Metric Thread Lengths Available)					Cable Bedding Diameter "A"		Overall Cable Diameter "B"		Armour Range		Across Flats "D"	Across Corners "D"	Protrusion Length "E"	Combined Ordering Reference (*Brass Metric)			Shroud	Cable Gland Weight (Kgs)
	Standard			Option											Size	Type	Ordering Suffix		
	Metric	Thread Length (Metric) "E"	NPT	Thread Length (NPT) "E"	NPT	Min	Max	Min	Max	Min	Max	Max	Max						
20S16	M20	15.0	1/2"	19.9	3/4"	3.1	8.6	6.1	13.1	0.8	1.25	24.0	26.4	72.5	20S16	E1FW	1RA	PVC04	0.16
20S	M20	15.0	1/2"	19.9	3/4"	6.1	11.6	9.5	15.9	0.8	1.25	24.0	26.4	70.0	20S	E1FW	1RA	PVC04	0.15
20	M20	15.0	1/2"	19.9	3/4"	6.5	13.9	12.5	20.9	0.8	1.25	30.5	33.6	73.0	20	E1FW	1RA	PVC06	0.21
25S	M25	15.0	3/4"	20.2	1"	11.1	19.9	14.0	22.0	1.25	1.6	37.5	41.3	89.0	25S	E1FW	1RA	PVC09	0.33
25	M25	15.0	3/4"	20.2	1"	11.1	19.9	18.2	26.2	1.25	1.6	37.5	41.3	89.0	25	E1FW	1RA	PVC09	0.33
32	M32	15.0	1"	25.0	1 1/4"	17.0	26.2	23.7	33.9	1.6	2.0	46.0	50.6	86.0	32	E1FW	1RA	PVC11	0.43
40	M40	15.0	1 1/4"	25.6	1 1/2"	22.0	32.1	27.9	40.4	1.6	2.0	55.0	60.5	90.0	40	E1FW	1RA	PVC15	0.62
50S	M50	15.0	1 1/2"	26.1	2"	29.5	38.1	35.2	46.7	2.0	2.5	60.0	66.0	91.0	50S	E1FW	1RA	PVC18	0.75
50	M50	15.0	2"	26.9	2 1/2"	35.6	44.0	40.4	53.0	2.0	2.5	70.1	77.1	95.0	50	E1FW	1RA	PVC21	0.95
63S	M63	15.0	2"	26.9	2 1/2"	40.1	49.9	45.6	59.4	2.0	2.5	75.0	82.5	102.0	63S	E1FW	1RA	PVC23	1.34
63	M63	15.0	2 1/2"	39.9	3"	47.2	55.9	54.6	65.8	2.0	2.5	80.0	88.0	104.0	63	E1FW	1RA	PVC25	1.34
75S	M75	15.0	2 1/2"	39.9	3"	52.8	61.9	59.0	72.0	2.0	2.5	90.0	99.0	115.0	75S	E1FW	1RA	PVC28	2.11
75	M75	15.0	3"	41.5	3 1/2"	59.1	67.9	66.7	78.4	2.5	3.0	100.0	110.0	117.0	75	E1FW	1RA	PVC30	2.42
90	M90	24.0	3 1/2"	42.8	4"	66.6	78.6	76.2	90.3	3.15	4.0	114.3	125.4	147.0	90	E1FW	1RA	PVC32	4.21
100	M100	24.0	3 1/2"	42.8	4"	76.0	90.9	86.1	101.4	3.15	4.0	123.0	135.3	140.0	100	E1FW	1RA	LSF33	4.45
115	M115	24.0	4"	44.0	5"	86.0	97.9	101.5	110.2	3.15	4.0	133.4	146.7	162.0	115	E1FW	1RA	LSF34	6.19
130	M130	24.0	5"	46.8	-	97.0	114.9	110.2	123.2	3.15	4.0	152.4	167.6	174.0	130	E1FW	1RA	LSF35	8.34

*Note : For material options please add the following suffix to change the Ordering Reference : Brass (no suffix required), Nickel Plated Brass "5", Copper Free Aluminium "1"
 For NPT options please add the following digits to the material suffix : 1/2" = 31, 3/4" = 32, 1" = 33, 1 1/4" = 34, 1 1/2" = 35, 2" = 36, 2 1/2" = 37, 3" = 38, 3 1/2" = 39, 4" = 310 (Brass requires prefix "0")

Examples: 32E1FW1RA534 = Nickel Plated Brass 1 1/4" NPT, 50SE1FW1RA035 = Brass 1 1/2" NPT, 20E1FW1RA5 = Nickel Plated Brass M20

Dimensions are displayed in millimetres unless otherwise stated

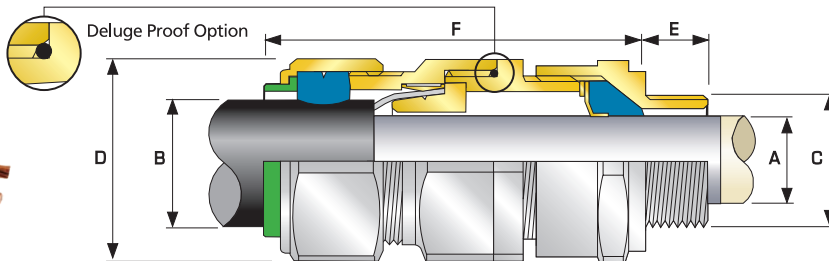

E2FW



E2FW Globally Approved, Explosive Atmosphere Cable Gland

For Lead Sheathed Steel & Aluminium Wire Armoured Cables

- Effectively earths / grounds lead sheathed cables
- Metal-to-metal armour clamping
- Direct & remote installation
- Displacement type flameproof inner seal
- Controlled outer 'load retention' seal
- Unique OSTG prevents overtightening
- 60°C to +130°C
- Globally marked, IECEx, ATEX & cCSAus
- Superior EMC performance



TECHNICAL DATA	
Design Specification	BS 6121:Part 1:1989, IEC 62444, EN 62444
Mechanical Classifications*	Impact = Level 8, Cable Anchorage = Class D
Enclosure Protection	IK10 to IEC 62262 (20 joules) Brass & Stainless Steel only
Electrical Classifications*	Category B
ATEX Certificate	SIRA13ATEX1071X, SIRA13ATEX4077X
Code of Protection	⊕ II 2G, II 1D, Ex d IIC Gb, Ex e IIC Gb, Ex ta IIIC Da, ⊕ II 3G Ex nR IIC Gc, ⊕ IM2 Ex d I Mb, Ex e I Mb
Compliance Standards	EN 60079-0,1,7,15,31
IECEx Certificate	IECEx SIR 13.0026X, IECEx SIM 14.0007X
Code of Protection	Ex d IIC Gb, Ex e IIC Gb, Ex nR IIC Gc, Ex ta IIIC Da, Ex d I Mb, Ex e I Mb
Compliance Standards	IEC 60079-0,1,7,15,31
cCSAus Certificate (20S16 - 90)	1310517
CSAus Code of Protection	Class I, Div 2, Groups A,B,C and D, Class II, Div 2, Groups E,F and G, Class III, Enclosure Type 3, 4 and 4X, Class I, Zone 1, AEx e II, AEx nR II
cCSA Code of Protection	Class I, Div 2, Groups A,B,C and D, Class II, Div 2, Groups E,F and G, Class III, Enclosure Type 3, 4 and 4X, Ex d IIC, Ex e IIC, Ex nR II
Compliance Standards	CAN/CSA-C22.2 No 0, 18, 25, 30, 94, 174, CAN/CSA-E60079-0, 1, 7, ANSI/UL 514B Ed 5, ANSI/UL 50 Ed 11, ANSI/UL 2225 Ed 4, UL60079-0, 1, 7
EAC Certificate	TC RU C-GB.Г605.В00138
UkrSEPRO	UA.TR.047.C.0644-15
KCS Certificate	14-GA4B0-0257X
CCOE / PESO (India) Certificate	P333688
NEPSI Certificate	GYJ13.1140X / GYJ13.1282X
INMETRO Approval	TÜV 12.0618X
RETIE Approval Number	03866
Marine Approvals	LRS: 01/00172 (E3), DNV: E-13848, ABS: 14-LD234401A-4-PDA, BV: 43180/A1
Ingress Protection Rating**	IP66 as standard (IP67, IP68*** available upon request)
Deluge Protection Compliance	DTS01:91 option available on request (white ferrule for identification purposes)
Cable Gland Material	Brass, Electroless Nickel Plated Brass, Aluminium
Seal Material	CMP SOLO LSF Halogen Free Thermoset Elastomer
Cable Type	Lead Sheathed & Single Wire Armour (SWA), Lead Sheathed & Aluminium Wire Armour (AWA)
Armour Clamping	Detachable Armour Cone & AnyWay Universal Clamping Ring
Sealing Technique	CMP Inner Displacement Seal & Unique CMP 'LRS'™ Outer Load Retention Seal
Sealing Area(s)	Cable Inner Lead Covering & Cable Outer Sheath

* Mechanical & Electrical Classifications applied as per IEC 62444 & EN 62444
 ** When CMP installation accessories are used. Refer to page 7 or www.cmp-products.com for further information.
 *** IP68 tested to a minimum depth of 30 metres for 12 hours, alternate depths / durations can be provided upon request

Cable Gland Selection Table

Refer to illustration at the top of the page.

Dimensions listed below are for metric cable glands only
 Dimensions for alternative threads may vary, please see supplementary technical data sheet

Cable Gland Size	Available Entry Threads "C" (Alternate Metric Thread Lengths Available)					Lead Sheath Diameter "A"		Overall Cable Diameter "B"		Armour Range		Across Flats "D"	Across Corners "D"	Protrusion Length "F"	Combined Ordering Reference (*Brass Metric)			Shroud	Cable Gland Weight (Kgs)
	Standard				Option										Size	Type	Ordering Suffix		
	Metric	Thread Length (Metric) "E"	NPT	Thread Length (NPT)	NPT														
20S16	M20	15.0	1/2"	19.9	3/4"	3.1	7.8	6.1	13.1	0.8	1.25	24.0	26.4	72.5	20S16	E2FW	1RA	PVC04	0.16
20S	M20	15.0	1/2"	19.9	3/4"	6.1	11.0	9.5	15.9	0.8	1.25	24.0	26.4	70.0	20S	E2FW	1RA	PVC04	0.15
20	M20	15.0	1/2"	19.9	3/4"	6.5	13.4	12.5	20.9	0.8	1.25	30.5	33.6	73.0	20	E2FW	1RA	PVC06	0.21
25S	M25	15.0	3/4"	20.2	1"	11.1	19.3	14.0	22.0	1.25	1.6	37.5	41.3	89.0	25S	E2FW	1RA	PVC09	0.33
25	M25	15.0	3/4"	20.2	1"	11.1	19.3	18.2	26.2	1.25	1.6	37.5	41.3	89.0	25	E2FW	1RA	PVC09	0.33
32	M32	15.0	1"	25.0	1 1/4"	17.0	25.5	23.7	33.9	1.6	2.0	46.0	50.6	86.0	32	E2FW	1RA	PVC11	0.43
40	M40	15.0	1 1/4"	25.6	1 1/2"	22.0	31.2	27.9	40.4	1.6	2.0	55.0	60.5	90.0	40	E2FW	1RA	PVC15	0.63
50S	M50	15.0	1 1/2"	26.1	2"	29.5	37.2	35.2	46.7	2.0	2.5	60.0	66.0	91.0	50S	E2FW	1RA	PVC18	0.76
50	M50	15.0	2"	26.9	2 1/2"	35.6	42.6	40.4	53.0	2.0	2.5	70.1	77.1	95.0	50	E2FW	1RA	PVC21	0.95
63S	M63	15.0	2"	26.9	2 1/2"	40.1	48.5	45.6	59.4	2.0	2.5	75.0	82.5	102.0	63S	E2FW	1RA	PVC23	1.35
63	M63	15.0	2 1/2"	39.9	3"	47.2	54.2	54.6	65.8	2.0	2.5	80.0	88.0	104.0	63	E2FW	1RA	PVC25	1.35
75S	M75	15.0	2 1/2"	39.9	3"	52.8	60.2	59.0	72.0	2.0	2.5	90.0	99.0	115.0	75S	E2FW	1RA	PVC28	2.12
75	M75	15.0	3"	41.5	3 1/2"	59.1	65.2	66.7	78.4	2.5	3.0	100.0	110.0	117.0	75	E2FW	1RA	PVC30	2.43
90	M90	24.0	3 1/2"	42.8	4"	66.6	77.1	76.2	90.3	3.15	4.0	114.3	125.4	147.0	90	E2FW	1RA	PVC32	4.23
100	M100	24.0	3 1/2"	42.8	4"	76.0	88.1	86.1	101.4	3.15	4.0	123.0	135.3	140.0	100	E2FW	1RA	LSF33	4.47
115	M115	24.0	4"	44.0	5"	86.0	94.1	101.5	110.2	3.15	4.0	133.4	146.7	162.0	115	E2FW	1RA	LSF34	6.22
130	M130	24.0	5"	46.8	-	97.0	110.1	110.2	123.2	3.15	4.0	152.4	167.6	174.0	130	E2FW	1RA	LSF35	8.38

*Note : For material options please add the following suffix to change the Ordering Reference ; Brass (no suffix required), Nickel Plated Brass "S", Copper Free Aluminium "1"
 For NPT options add the following digits to the material suffix; 1/2" = 31; 3/4" = 32; 1" = 33; 1 1/4" = 34; 1 1/2" = 35; 2" = 36; 2 1/2" = 37; 3" = 38; 3 1/2" = 39; 4" = 310 (Brass requires prefix '0')

Examples: 32E2FW1RA534 = Nickel Plated Brass 1 1/4" NPT, 50SE2FW1RA035 = Brass 1 1/2" NPT, 20E2FW1RA5 = Nickel Plated Brass M20

Dimensions are displayed in millimetres unless otherwise stated



CMP EXPLOSIVE ATMOSPHERE RAPIDEX PRODUCTS





Explosive Atmosphere RapidEx Barrier Cable Glands

RapidEx is a liquid pour, fast curing, liquid resin seal that installs in seconds and cures in minutes. Its unique formula begins with a low viscosity liquid that flows into the cable interstices completely surrounding the cable conductors, driving out the air in the process. The viscosity then increases and completely cures in minutes, dependent on ambient temperature.

During application the liquid resin flows between and around the cable conductors ensuring a complete and total seal with zero gaps. In the process of curing, the RapidEx resin adheres to both the cable conductors and the inside of the barrier tube creating a bond that is set for the life of the Cable Gland product.

The RapidEx seal will not crack or shrink with changes in temperature.

All Cable Glands shown in Nickel Plated Brass, alternative materials are available.





RapidEx - The Fast Curing, Gas Blocking, Liquid Resin Seal



The effective sealing of instrument and electrical cables should not be underestimated.

Traditional barrier type Cable Glands employing an epoxy-cured clay based sealing compound, have been used in the industry for many years, to provide effective explosion protection. However, a certain degree of skill is required with this traditional installation process and the risk of voids increases with the number of cable cores.

Multi-core cable requires the highest degree of competence and a long installation time to ensure a void-free, safe installation. An inability to recognize this will lead to rework, or risk of failure of the seal.

RapidEx is a liquid pour, fast curing, liquid resin barrier seal that installs in seconds and cures in minutes.

Its unique formula begins with a low viscosity liquid that flows into the cable interstices completely surrounding the cable conductors, and in the process displacing the air from the Cable Gland's sealing chamber ensuring the 'perfect seal'.

- The viscosity increases and completely cures in less than 40 minutes (at 68°F)
- Enhances reliability, reduces risk
- Delivers unprecedented reliability
- Minimizes installation time
- Clean and easy to use

CMP RapidEx is certified for use in hazardous locations with Global Certification including approval under NEC, CEC and IEC installation codes, and is supplied with a series of CMP barrier type cable glands and unions.



		Cable Gland Size																
		20S	20	25	25S	32	40s	40	50S	50	63S	63	75S	75	90	100	115	
Thread Size	M20	1 X 30	1 X 30															
	M25			1 X 30	1 X 30													
	M32					1 X 30												
	M40							1 X 30										
	M50								1 X 80	1 X 80								
	M63										1 X 80	1 X 80						
	M75												2 X 80	2 X 80				
	M90														2 X 80			
	M100															3 X 80		
	1/2"	1 X 30	1 X 30															
	3/4"	1 X 30	1 X 30	1 X 30														
	1"			1 X 30	1 X 30	1 X 30	1 X 30											
	1 1/4"					1 X 30	1 X 30	1 X 30										
	1 1/2"						1 X 30	1 X 30	1 X 30	1 X 30								
	2"								1 X 80	1 X 80	1 X 80	1 X 80						
	2 1/2"										2 X 80	2 X 80	2 X 80	2 X 80				
	3"													3 X 80	3 X 80	3 X 80		
	3 1/2"														3 X 80	3 X 80		
	4"															3 X 80	3 X 80	

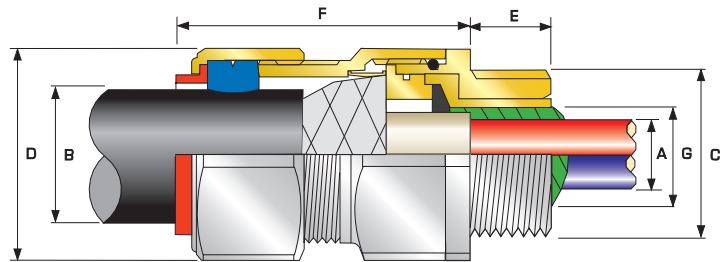
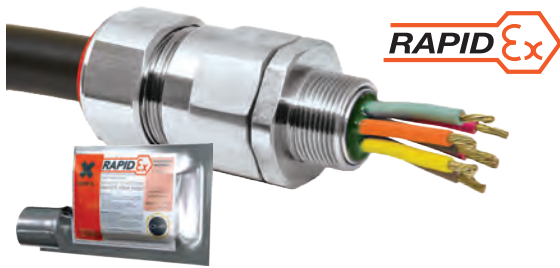

PX2KREX Ex e Exd ExnR Exta

PX2KREX Globally Approved, Explosive Atmosphere RapidEx Barrier Cable Gland

For all types of Armoured Cables

- RapidEx liquid pour sealing system
 - Enhances reliability, reduces risk
 - Reduces man hours
 - Reduces cost
- Metal-to-metal armour clamping
- Direct & remote installation
- Integral protected deluge seal
- Controlled outer 'load retention' seal
- Unique OSTG prevents overtightening
- -60°C to +85°C
- Globally marked, IECEx, ATEX & cCSAus
- Superior EMC performance



† Grooved Cone (X) is predominantly used for Wire Braid (e.g. GSWB, TCWB), Steel Tape Armour (STA, DSTA) and Aluminium Strip Armour (ASA) but is also suitable for Single Wire Armour (SWA), Aluminium Wire Armour (AWA) and Pliable Wire Armour (PWA) if the range is outside that of the Stepped Cone (W).
 Grooved Cone (X) dimensions shown in the Cable Gland Selection Table below are for a double wire strand of braid armour cables. Tapes can also be doubled over. For cables that have only a single layer of armour such as SWA the clamping range should be used as shown in the table below.
 Stepped (W) Cone is suitable for Single Wire Armour (SWA), or Aluminium Wire Armour (AWA) cables.

TECHNICAL DATA	
Design Specification	BS 6121:Part 1:1989, IEC 62444, EN 62444
Mechanical Classifications*	Impact = Level 8, Cable Anchorage = Class D
Enclosure Protection	IK10 to IEC 62262 (20 joules) Brass & Stainless Steel only
Electrical Classifications*	Category B (Category A when used with braid, tape or pliable wire armour cables)
ATEX Certificate	SIRA13ATEX1072X, SIRA13ATEX4078X
Code of Protection	⊕ II 2G, II 1D, Ex d IIC Gb, Ex e IIC Gb, Ex ta IIIC Da ⊕ II 3G Ex nR IIC Gc, ⊕ IM2 Ex d I Mb, Ex e I Mb
Compliance Standards	EN 60079-0,1,7,15,31
IECEx Certificate	IECEx SIR 13.0027X, IECEx SIM 14.0008X
Code of Protection	Ex d IIC Gb, Ex e IIC Gb, Ex nR IIC Gc, Ex ta IIIC Da, Ex d I Mb, Ex e I Mb
Compliance Standards	IEC 60079-0,1,7,15,31
cCSAus Certificate (20S16 - 100)	2288626
CSAus Code of Protection***	Class I, Div. 1, 2 Groups A, B, C and D; Class II, Div. 1, 2 Groups E, F and G; Class III, Div. 1, 2; Type 4X; Oil Resistant II: Class I, Zone 1 AEx d IIC Gb, AEx e IIC Gb, Class I, Zone 2 AEx nR IIC Gc, Class I, Zone 20 AEx ta IIIC Da
cCSA Code of Protection***	Class I, Div. 1, 2 Groups A, B, C and D; Class II, Div. 1, 2 Groups E, F and G; Class III, Div. 1, 2; Type 4X; Oil Resistant II: Ex d IIC Gb, Ex e IIC Gb, Ex nR IIC Gc, Ex ta IIIC Da
Compliance Standards	CAN/CSA-C22.2 No 0,18,25,30,94,174, CAN/CSA-E60079-0,1,7,15,31 CAN/CSA-E6124111 Part 11, ANSI/UL 514B Ed 5, ANSI/UL 50 Ed 11, ANSI/UL 2225 Ed 4, UL60079
EAC Certificate	TC RU C-GB. ГБ05.B.00138
UkrSEPRO	UA.TR.047.C.0644-15
CCOE / PESO (India) Certificate	P333688
NEPSI Certificate	GYJ13.1140X / GYJ13.1282X
INMETRO Approval	TÜV 12.2073X
RETIE Approval Number	03866
Marine Approvals	LRS: 01/00172 (E3) DNV: E-13848 ABS: 14-LD234401A-4-PDA, BV: 43180/A1
Ingress Protection Rating**	IP66, IP67 & IP68****
Deluge Protection Compliance	DTS01 : 91
Cable Gland Material	Brass, Electroless Nickel Plated Brass, Stainless Steel, Aluminium
Seal Material	CMP SOLO LSF Halogen Free Thermoset Elastomer / RapidEx Resin Barrier
Cable Type	Single Wire Armour (SWA), Aluminium Wire Armour (AWA), Wire Braid Armour (e.g. SWB), Screened Flexible (EMC) Wire Braid (e.g. CY / SY), Pliable Wire Armour (PWA), Steel Tape Armour (STA), Strip Armour (e.g. ASA)****
Armour Clamping	Detachable Resin Tube / Cone & AnyWay Universal Clamping Ring
Sealing Technique	Unique CMP 'LRS' Outer Seal (Load Retention Seal)
Sealing Area(s)	Inner RapidEx Barrier Seal & Outer Sheath

* Mechanical & Electrical Classifications applied as per IEC 62444 & EN 62444
 ** When CMP installation accessories are used. Refer to page 7 or www.cmp-products.com for further information.
 *** Where the cable is permitted by code (NEC and/or CEC)
 **** IP68 tested to a minimum depth of 30 metres for 12 hours, alternate depths / durations can be provided upon request

Cable Gland Selection Table

Refer to illustration at the top of the page.

Dimensions listed below are for metric cable glands only
 Dimensions for alternative threads may vary, please see supplementary technical data sheet

Cable Gland Size	Available Entry Threads "C" (Alternate Metric Thread Lengths Available)				Number of Cores	Diameter Over Conductors "A"	Cable Bedding Diameter "G"	Overall Cable Diameter "B"	Armour Range †				Across Flats "D"	Across Corners "D"	Protrusion Length "F"	Combined Ordering Reference (*Brass Metric)			Shroud	Cable Gland Weight (Kgs)		
	Standard		Option						Grooved Cone (X)		Stepped Cone (W)					Size	Type	Ordering Suffix				
	Metric	Thread Length (Metric) "E"	NPT	Thread Length (NPT) "E"					Min	Max	Min	Max										
20S16	M20	15.0	1/2"	19.9	3/4"	11	11.7	6.1	13.1	0.3	1.0	0.8	1.25	30.5	33.6	62.0	20S16	PX2KREX	1RA	PVC06	0.24	
20S	M20	15.0	1/2"	19.9	3/4"	11	11.7	9.5	15.9	0.3	1.0	0.8	1.25	30.5	33.6	62.0	20S	PX2KREX	1RA	PVC06	0.23	
20	M20	15.0	1/2"	19.9	3/4"	11	12.6	12.5	20.9	0.4	1.0	0.8	1.25	30.5	33.6	63.0	20	PX2KREX	1RA	PVC06	0.24	
25S	M25	15.0	3/4"	20.2	1"	21	17.5	14.0	22.0	0.4	1.2	1.25	1.6	37.5	41.3	69.5	25S	PX2KREX	1RA	PVC09	0.37	
25	M25	15.0	3/4"	20.2	1"	21	17.5	17.9	18.2	26.2	0.4	1.2	1.25	1.6	37.5	41.3	69.5	25	PX2KREX	1RA	PVC09	0.37
32	M32	15.0	1"	25.0	1 1/4"	38	23.6	23.9	23.7	33.9	0.4	1.2	1.6	2.0	46.0	50.6	75.0	32	PX2KREX	1RA	PVC11	0.57
40	M40	15.0	1 1/4"	25.6	1 1/2"	59	30.0	30.3	27.9	40.4	0.4	1.6	1.6	2.0	55.0	60.5	75.0	40	PX2KREX	1RA	PVC15	0.80
50S	M50	15.0	1 1/2"	26.1	2"	89	36.6	36.9	35.2	46.7	0.4	1.6	2.0	2.5	60.0	66.0	77.0	50S	PX2KREX	1RA	PVC18	0.90
50	M50	15.0	2"	26.9	2 1/2"	89	41.0	41.3	40.4	53.0	0.6	1.6	2.0	2.5	70.0	77.0	77.0	50	PX2KREX	1RA	PVC21	1.19
63S	M63	15.0	2"	26.9	2 1/2"	115	47.9	48.4	45.6	59.4	0.6	1.6	2.0	2.5	75.0	82.5	79.7	63S	PX2KREX	1RA	PVC23	1.39
63	M63	15.0	2 1/2"	39.9	3"	115	53.7	54.0	54.6	65.8	0.6	1.6	2.0	2.5	80.0	88.0	80.3	63	PX2KREX	1RA	PVC25	1.41
75S	M75	15.0	2 1/2"	39.9	3"	140	59.9	60.2	59.0	72.0	0.6	1.6	2.0	2.5	90.0	99.0	86.8	75S	PX2KREX	1RA	PVC28	2.09
75	M75	15.0	3"	41.5	3 1/2"	140	64.2	64.2	66.7	78.4	0.6	1.6	2.5	3.0	100.0	110.0	88.3	75	PX2KREX	1RA	PVC30	2.54
90	M90	20.0	3 1/2"	42.8	4"	24.0	75.3	75.6	76.2	90.3	0.8	1.6	3.15	4.0	115.0	126.5	102.1	90	PX2KREX	1RA	PVC32	3.71
100	M100	20.0	3 1/2"	42.8	4"	24.0	85.6	85.9	86.1	101.4	0.8	1.6	3.15	4.0	127.0	139.7	114.0	100	PX2KREX	1RA	LSF33	4.81

*For material options add the following suffix to the Ordering Reference; Brass (no suffix required); Nickel Plated Brass '5'; 316 Grade Stainless Steel '4'; Copper Free Aluminium '1'
 For NPT options please add the following digits to the material suffix; 1/2" = 31, 3/4" = 32, 1" = 33, 1 1/4" = 34, 1 1/2" = 35, 2" = 36, 2 1/2" = 37, 3" = 38, 3 1/2" = 39, 4" = 310 (Brass requires prefix "0")
 Examples: 32PX2KREX1RA534 = Nickel Plated Brass 1 1/4" NPT, 50SPX2KREX1RA035 = Brass 1 1/2" NPT, 25PX2KREX1RA432 = Stainless Steel 3/4" NPT, 20PX2KREX1RA5 = Nickel Plated Brass M20

Dimensions are displayed in millimetres unless otherwise stated

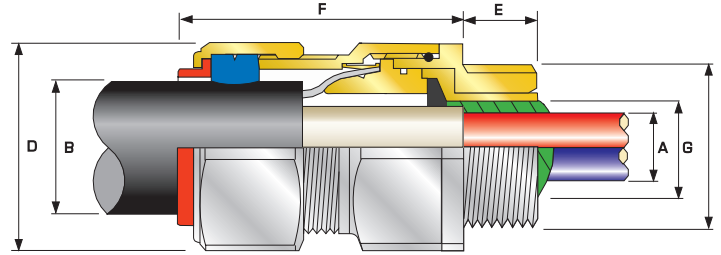
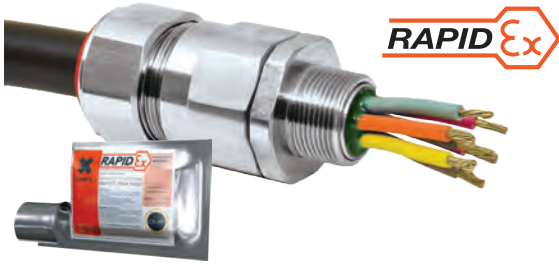

PX2KWREX



PX2KWREX Globally Approved, Explosive Atmosphere RapidEx Barrier Cable Gland

For all types of Steel & Aluminium Wire Armoured Cables

- RapidEx liquid pour sealing system
 - Enhances reliability, reduces risk
 - Reduces man hours
 - Reduces cost
- Metal-to-metal armour clamping
- Direct & remote installation
- Integral protected deluge seal
- Controlled outer 'load retention' seal
- Unique OSTG prevents overtightening
- -60°C to +85°C
- Globally marked, IECEx, ATEX & cCSAus
- Superior EMC performance



TECHNICAL DATA

Design Specification	BS 6121:Part 1:1989, IEC 62444, EN 62444
Mechanical Classifications*	Impact = Level 8, Cable Anchorage = Class D
Enclosure Protection	IK10 to IEC 62262 (20 joules) Brass & Stainless Steel only
Electrical Classifications*	Category B
ATEX Certificate	SIRA13ATEX1072X, SIRA13ATEX4078X
Code of Protection	⊕ II 2G, II 1D, Ex d IIC Gb, Ex e IIC Gb, Ex ta IIC Da ⊕ II 3G Ex nR IIC Gc, ⊕ IM2 Ex d I Mb, Ex e I Mb
Compliance Standards	EN 60079-0, 1, 7, 15, 31
IECEX Certificate	IECEX SIR 13.0027X, IECEx SIM 14.0008X
Code of Protection	Ex d IIC Gb, Ex e IIC Gb, Ex nR IIC Gc, Ex ta IIC Da, Ex d I Mb, Ex e I Mb
Compliance Standards	IEC 60079-0, 1, 7, 15, 31
cCSAus Certificate (20S16 - 100)	2288626
CSAus Code of Protection***	Class I, Div. 2 Groups A, B, C and D; Class II, Div. 2 Groups F and G; Class III, Div. 2; Type 4X: Oil Resistant II: Class I, Zone 1 AEx d IIC Gb, AEx e IIC Gb, Class I, Zone 2 AEx nR IIC Gc, Class I, Zone 20 AEx ta IIC Da
cCSA Code of Protection***	Class I, Div. 2 Groups A, B, C and D; Class II, Div. 2 Groups F and G; Class III, Div. 2; Type 4X: Oil Resistant II: Ex d IIC Gb, Ex e IIC Gb, Ex nR IIC Gc, Ex ta IIC Da
Compliance Standards	CAN/CSA-C22.2 No 0, 18, 25, 30, 94, 174, CAN/CSA-E60079-0, 1, 7, 31 CAN/CSA-E6124111 Part 11, ANSI/UL 514B Ed 5, ANSI/UL 50 Ed 11, ANSI/UL 2225 Ed 4, UL60079
EAC Certificate	TC RU C-GB.Г505.В00138
UkrSEPRO	UA.TR.047.C.0644-15
CCOE / PESO (India) Certificate	P333688
NEPSI Certificate	GYJ13.1140X / GYJ13.1282X
INMETRO Approval	TÜV 12.2073X
RETIE Approval Number	03866
Marine Approvals	LRS: 01/00172 (E3) DNV: E-13848 ABS: 14-LD234401A-4-PDA, BV: 43180/A1
Ingress Protection Rating**	IP66, IP67 & IP68****
Deluge Protection Compliance	DTS01 : 91
Cable Gland Material	Electroless Nickel Plated Brass, Brass, Stainless Steel, Aluminium
Seal Material	CMP SOLO LSF Halogen Free Thermoset Elastomer / RapidEx Barrier Compound
Cable Type	Single Wire Armour (SWA), Aluminium Wire Armour (AWA)***
Armour Clamping	Detachable Resin Tube / Cone & AnyWay Universal Clamping Ring
Sealing Technique	Unique CMP 'LRS' Outer Seal (Load Retention Seal)
Sealing Area(s)	RapidEx Resin Barrier & Cable Outer Sheath

* Mechanical & Electrical Classifications applied as per IEC 62444 & EN 62444

** When CMP installation accessories are used. Refer to page 7 or www.cmp-products.com for further information.

***Where the cable is permitted by code (NEC and/or CEC)

**** IP68 tested to a minimum depth of 30 metres for 12 hours, alternate depths / durations can be provided upon request

Cable Gland Selection Table

Refer to illustration at the top of the page.

Dimensions listed below are for metric cable glands only
Dimensions for alternative threads may vary, please see supplementary technical data sheet

Cable Gland Size	Available Entry Threads "C" (Alternate Metric Thread Lengths Available)				Number of Cores	Diameter Over Conductors "A"	Cable Bedding Diameter "G"	Overall Cable Diameter "B"		Armour Range		Across Flats "D"	Across Corners "D"	Protrusion Length "F"	Combined Ordering Reference (*Brass Metric)			Shroud	Cable Gland Weight (Kgs)		
	Standard			Option				Min	Max	Min	Max				Max	Max	Size			Type	Ordering Suffix
	Metric	Thread Length (Metric) "E"	NPT	Thread Length (NPT) "E"																	
20S16	M20	15.0	1/2"	0.78	3/4"	11	11.7	11.7	6.1	13.1	0.8	1.25	30.5	33.6	62.0	20S16	PX2KWREX	1RA	PVC06	0.24	
20S	M20	15.0	1/2"	0.78	3/4"	11	11.7	11.7	9.5	15.9	0.8	1.25	30.5	33.6	62.0	20S	PX2KWREX	1RA	PVC06	0.23	
20	M20	15.0	1/2"	0.78	3/4"	11	12.6	12.9	12.5	20.9	0.8	1.25	30.5	33.6	63.0	20	PX2KWREX	1RA	PVC06	0.24	
25S	M25	15.0	3/4"	0.80	1"	21	17.5	17.9	14.0	22.0	1.25	1.6	37.5	41.3	69.5	25S	PX2KWREX	1RA	PVC09	0.37	
25	M25	15.0	3/4"	0.80	1"	21	17.5	17.9	18.2	26.2	1.25	1.6	37.5	41.3	69.5	25	PX2KWREX	1RA	PVC09	0.37	
32	M32	15.0	1"	0.98	1 1/4"	38	23.6	23.9	23.7	33.9	1.6	2.0	46.0	50.6	75.0	32	PX2KWREX	1RA	PVC11	0.57	
40	M40	15.0	1 1/4"	1.01	1 1/2"	59	30.0	30.3	27.9	40.4	1.6	2.0	55.0	60.5	75.0	40	PX2KWREX	1RA	PVC15	0.80	
50S	M50	15.0	1 1/2"	1.03	2"	89	36.6	36.9	35.2	46.7	2.0	2.5	60.0	66.0	77.0	50S	PX2KWREX	1RA	PVC18	0.90	
50	M50	15.0	2"	1.06	2 1/2"	89	41.0	41.3	40.4	53.0	2.0	2.5	70.1	77.1	77.0	50	PX2KWREX	1RA	PVC21	1.19	
63S	M63	15.0	2"	1.06	2 1/2"	115	47.9	48.4	45.6	59.4	2.0	2.5	75.0	82.5	79.7	63S	PX2KWREX	1RA	PVC23	1.39	
63	M63	15.0	2 1/2"	1.57	3"	115	53.7	54.0	54.6	65.8	2.0	2.5	80.0	88.0	80.3	63	PX2KWREX	1RA	PVC25	1.41	
75S	M75	15.0	2 1/2"	1.57	3"	140	59.9	60.2	59.0	72.0	2.0	2.5	90.0	99.0	86.8	75S	PX2KWREX	1RA	PVC28	2.09	
75	M75	15.0	3"	1.63	3 1/2"	140	64.2	64.2	66.7	78.4	2.5	3.0	100.0	110.0	88.3	75	PX2KWREX	1RA	PVC30	2.54	
90	M90	24.0	3 1/2"	1.69	4"	200	75.3	75.6	76.2	90.3	3.15	4.0	115.0	126.5	102.1	90	PX2KWREX	1RA	PVC32	3.71	
100	M100	24.0	3 1/2"	1.69	4"	200	85.6	85.9	86.1	101.4	3.15	4.0	127.0	139.7	114.0	100	PX2KWREX	1RA	LSF33	4.81	

*For material options add the following suffix to the Ordering Reference; Brass (no suffix required); Nickel Plated Brass 'S'; 316 Grade Stainless Steel '4'; Copper Free Aluminium '1'
For NPT options please add the following digits to the material suffix; 1/2" = 31, 3/4" = 32, 1" = 33, 1 1/4" = 34, 1 1/2" = 35, 2" = 36, 2 1/2" = 37, 3" = 38, 3 1/2" = 39, 4" = 310 (Brass requires prefix "0")

Examples: 32PX2KWREX1RA534 = Nickel Plated Brass 1 1/4" NPT, 50SPX2KWREX1RA035 = Brass 1 1/2" NPT, 25PX2KWREX1RA432 = Stainless Steel 3/4" NPT, 20PX2KWREX1RA5 = Nickel Plated Brass M20

Dimensions are displayed in millimetres unless otherwise stated

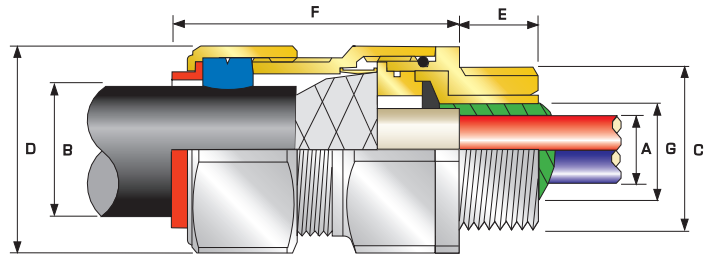
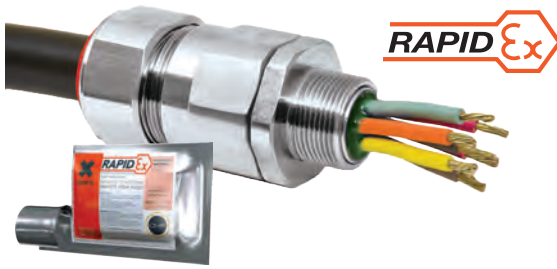

PX2KXREX



PX2KXREX Globally Approved, Explosive Atmosphere RapidEx Barrier Cable Gland

For all types of Braided & Tape Armoured Cables

- RapidEx liquid pour sealing system
 - Enhances reliability, reduces risk
 - Reduces man hours
 - Reduces cost
- Metal-to-metal armour clamping
- Direct & remote installation
- Integral protected deluge seal
- Controlled outer 'load retention' seal
- Unique OSTG prevents overtightening
- -60°C to +85°C
- Globally marked, IECEx, ATEX & cCSAus
- Superior EMC performance



† Grooved Cone (X) is predominantly used for Wire Braid (e.g. GSWB, TCWB), Steel Tape Armour (STA, DSTA) and Aluminium Strip Armour (ASA) but is also suitable for Single Wire Armour (SWA), Aluminium Wire Armour (AWA) and Pliable Wire Armour (PWA) if the range is outside that of the Stepped Cone (W).

Grooved Cone (X) dimensions shown in the Cable Gland Selection Table below are for a double wire stand of braid armour cables. Tapes can also be doubled over. For cables that have only a single layer of armour such as SWA the clamping range should be used as shown in the table below.

TECHNICAL DATA

Design Specification	BS 6121:Part 1:1989, IEC 62444, EN 62444
Mechanical Classifications*	Impact = Level 8, Cable Anchorage = Class D
Enclosure Protection	IK10 to IEC 62262 (20 joules) Brass & Stainless Steel only
Electrical Classifications*	Category B (Category A when used with braid, tape or pliable wire armour cables)
ATEX Certificate	SIRA13ATEX1072X, SIRA13ATEX4078X
Code of Protection	⊕ II 2G, II 1D, Ex d IIC, Ex e IIC Gb, Ex ta IIIC Da ⊕ II 3G Ex nR IIC Gc, ⊕ IM2 Ex d I Mb, Ex e I Mb
Compliance Standards	EN 60079-0,1,7,15,31
IECEx Certificate	IECEx SIR 13.0027X, IECEx SIM 14.0008X
Code of Protection	Ex d IIC Gb, Ex e IIC Gb, Ex nR IIC Gc, Ex ta IIIC Da, Ex d I Mb, Ex e I Mb
Compliance Standards	IEC 60079-0,1,7,15,31
cCSAus Certificate (20S16 - 100)	2288626
CSAus Code of Protection***	Class I, Div. 1, 2 Groups A, B, C and D; Class II, Div. 1, 2 Groups E, F and G; Class III, Div. 1, 2; Type 4X: Oil Resistant II: Class I, Zone 1 AEx d IIC Gb, AEx e IIC Gb, Class I, Zone 2 AEx nR IIC Gc, Class I, Zone 20 AEx ta IIIC Da
cCSA Code of Protection***	Class I, Div. 1, 2 Groups A, B, C and D; Class II, Div. 1, 2 Groups E, F and G; Class III, Div. 1, 2; Type 4X: Oil Resistant II: Ex d IIC Gb, Ex e IIC Gb, Ex nR IIC Gc, Ex ta IIIC Da
Compliance Standards	CAN/CSA-C22.2 No 0,18,25,30,94,174, CAN/CSA-E60079-0,1,7,31 CAN/CSA-E612411 Part 11, ANSI/UL 514B Ed 5, ANSI/UL 50 Ed 11, ANSI/UL 2225 Ed 4, UL60079
EAC Certificate	TC RU C-GB.F605.B00138
UkrSEPRO	UA.TR.047.C.0644-15
CCOE / PESO (India) Certificate	P333688
NEPSI Certificate	GYJ13.1140X / GYJ13.1282X
INMETRO Approval	TÜV 12.2073X
RETIE Approval Number	03866
Marine Approvals	LRS: 01/00172 (E3) DNV: E-13848 ABS: 14-LD234401A-4-PDA, BV: 43180/A1
Ingress Protection Rating**	IP66, IP67 & IP68****
Deluge Protection Compliance	DTS01 : 91
Cable Gland Material	Brass, Electroless Nickel Plated Brass, Stainless Steel, Aluminium
Seal Material	CMP SOLO LSF Halogen Free Thermoset Elastomer / RapidEx Resin Barrier
Cable Type	Screened Flexible (EMC) Wire Braid (e.g. CY / SY), Pliable Wire Armour (PWA), Steel Tape Armour (STA), Wire Braid Armour (e.g. SWB), Aluminium Strip Armour (ASA), Armoured & Jacketed***
Armour Clamping	Detachable Resin Tube / Cone & AnyWay Universal Clamping Ring
Sealing Technique	Unique CMP 'LRS' Outer Seal (Load Retention Seal)
Sealing Area(s)	Inner RapidEx Barrier Seal & Outer Sheath

* Mechanical & Electrical Classifications applied as per IEC 62444 & EN 62444
 ** When CMP installation accessories are used. Refer to page 7 or www.cmp-products.com for further information.
 *** Where the cable is permitted by code (NEC and/or CEC)
 **** IP68 tested to a minimum depth of 30 metres for 12 hours, alternate depths / durations can be provided upon request

Cable Gland Selection Table

Refer to illustration at the top of the page.

Dimensions listed below are for metric cable glands only
 Dimensions for alternative threads may vary, please see supplementary technical data sheet

Cable Gland Size	Available Entry Threads "C" (Alternate Metric Thread Lengths Available)					Number of Cores	Diameter Over Conductors "A"	Cable Bedding Diameter "G"	Overall Cable Diameter "B"		Armour Range † Grooved Cone (X)		Across Flats "D"		Across Corners "D"	Protrusion Length "F"	Combined Ordering Reference ("Brass Metric")			Shroud	Cable Gland Weight (Kgs)
	Standard		Option						Min	Max	Min	Max	Max	Max			Size	Type	Ordering Suffix		
	Metric	Thread Length (Metric) "E"	NPT	Thread Length (NPT) "E"	NPT																
20S16	M20	15.0	½"	19.9	¾"	11	11.7	11.7	6.1	13.1	0.3	1.0	30.5	33.6	62.0	20S16	PX2KXREX	1RA	PVC06	0.240	
20S	M20	15.0	½"	19.9	¾"	11	11.7	11.7	9.5	15.9	0.3	1.0	30.5	33.6	62.0	20S	PX2KXREX	1RA	PVC06	0.230	
20	M20	15.0	½"	19.9	¾"	11	12.6	12.9	12.5	20.9	0.4	1.0	30.5	33.6	63.0	20	PX2KXREX	1RA	PVC06	0.240	
25S	M25	15.0	¾"	20.2	1"	21	17.5	17.9	14.0	22.0	0.4	1.2	37.5	41.3	69.5	25S	PX2KXREX	1RA	PVC09	0.370	
25	M25	15.0	¾"	20.2	1"	21	17.5	17.9	18.2	26.2	0.4	1.2	37.5	41.3	69.5	25	PX2KXREX	1RA	PVC09	0.370	
32	M32	15.0	1"	25.0	1 ¼"	38	23.6	23.9	23.7	33.9	0.4	1.2	46.0	50.6	75.0	32	PX2KXREX	1RA	PVC11	0.570	
40	M40	15.0	1 ¼"	25.6	1 ½"	59	30.0	30.3	27.9	40.4	0.4	1.6	55.0	60.5	75.0	40	PX2KXREX	1RA	PVC15	0.800	
50S	M50	15.0	1 ½"	26.1	2"	89	36.6	36.9	35.2	46.7	0.4	1.6	60.0	66.0	77.0	50S	PX2KXREX	1RA	PVC18	0.900	
50	M50	15.0	2"	26.9	2 ½"	89	41.0	41.3	40.4	53.0	0.6	1.6	70.0	77.0	77.0	50	PX2KXREX	1RA	PVC21	1.190	
63S	M63	15.0	2"	26.9	2 ½"	115	47.9	48.4	45.6	59.4	0.6	1.6	75.0	82.5	79.7	63S	PX2KXREX	1RA	PVC23	1.390	
63	M63	15.0	2 ½"	39.9	3"	115	53.7	54.0	54.6	65.8	0.6	1.6	80.0	88.0	80.3	63	PX2KXREX	1RA	PVC25	1.410	
75S	M75	15.0	2 ½"	39.9	3"	140	59.9	60.2	59.0	72.0	0.6	1.6	90.0	99.0	86.8	75S	PX2KXREX	1RA	PVC28	2.090	
75	M75	15.0	3"	41.5	3 ½"	140	64.2	64.2	66.7	78.4	0.6	1.6	100.0	110.0	88.3	75	PX2KXREX	1RA	PVC30	2.540	
90	M90	24.0	3 ½"	42.8	4"	200	75.3	75.6	76.2	90.3	0.8	1.6	115.0	126.5	102.1	90	PX2KXREX	1RA	PVC32	3.710	
100	M100	24.0	3 ½"	42.8	4"	200	85.6	85.9	86.1	101.4	0.8	1.6	127.0	139.7	114.0	100	PX2KXREX	1RA	LSF33	4.810	

*For material options add the following suffix to the Ordering Reference; Brass (no suffix required); Nickel Plated Brass '5'; 316 Grade Stainless Steel '4'; Copper Free Aluminium '1'
 For NPT options please add the following digits to the material suffix; ½" = 31, ¾" = 32, 1" = 33, 1 ¼" = 34, 1 ½" = 35, 2" = 36, 2 ½" = 37, 3" = 38, 3 ½" = 39, 4" = 310 (Brass requires prefix "0")
 Examples: 32PX2KXREX1RA534 = Nickel Plated Brass 1 ¼" NPT, 50SPX2KXREX1RA035 = Brass 1 ½" NPT, 25PX2KXREX1RA432 = Stainless Steel ¾" NPT, 20PX2KXREX1RA5 = Nickel Plated Brass M20

Dimensions are displayed in millimetres unless otherwise stated

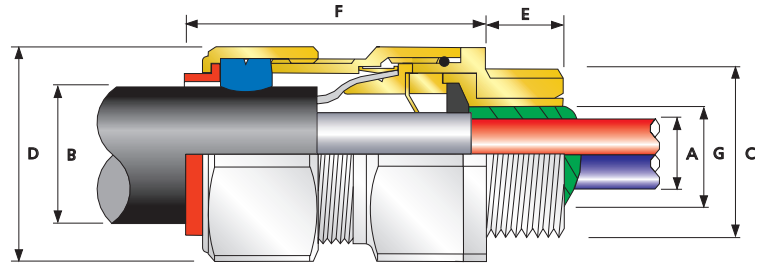

PX2KPBREX Ex e Ex d Ex nR Ex ta

PX2KPBREX Internationally Approved, Explosive Atmosphere RapidEx Barrier Cable Gland

For all types of Lead Sheathed Armoured Cables

- Effectively earths / grounds lead sheathed cables
- RapidEx liquid pour sealing system
 - Enhances reliability, reduces risk
 - Reduces man hours
 - Reduces cost
- Metal-to-metal armour clamping
- Direct & remote installation
- Integral protected deluge seal
- Controlled outer 'load retention' seal
- Unique OSTG prevents overtightening
- 60°C to +85°C
- Internationally marked, IECEx & ATEX
- Superior EMC performance



† Grooved Cone (X) is predominantly used for Wire Braid (e.g. CSWB, TCWB), Steel Tape Armour (STA, DSTA) and Aluminium Strip Armour (ASA) but is also suitable for Single Wire Armour (SWA), Aluminium Wire Armour (AWA) and Pliable Wire Armour (PWA) if the range is outside that of the Stepped Cone (W).

Grooved Cone (X) dimensions shown in the Cable Gland Selection Table below are for a double wire strand of braid armour cables. Tapes can also be doubled over. For cables that have only a single layer of armour such as SWA the clamping range should be used as shown in the table below.

Stepped (W) Cone is suitable for Single Wire Armour (SWA), or Aluminium Wire Armour (AWA) cables.

TECHNICAL DATA	
Design Specification	BS 6121:Part 1:1989, IEC 62444, EN 62444
Mechanical Classifications*	Impact = Level 8, Cable Anchorage = Class D
Enclosure Protection	IK10 to IEC 62262 (20 joules) Brass & Stainless Steel only
Electrical Classifications*	Category B (Category A when used with braid, tape or pliable wire armour cables)
ATEX Certificate	SIRA13ATEX1072X, SIRA13ATEX4078X
Code of Protection	Ⓢ II 2G, II 1D, Ex d IIC Gb, Ex e IIC Gb, Ex ta IIIC Da, Ⓢ II 3G Ex nR IIC Gc, Ⓢ IM2 Ex d I Mb, Ex e I Mb
Compliance Standards	EN 60079-0,1,7,15,31
IECEx Certificate	IECEx SIR 13.0027X, IECEx SIM 14.0008X
Code of Protection	Ex d IIC Gb, Ex e IIC Gb, Ex nR IIC Gc, Ex ta IIIC Da, Ex d I Mb, Ex e I Mb
Compliance Standards	IEC 60079-0,1,7,15,31
UkrSEPRO	UA.TR.047.C.0644-15
CCOE / PESO (India) Certificate	P333688
NEPSI Certificate	GYJ13.1140X / GYJ13.1282X
INMETRO Approval	TÜV 12.2073X
RETIE Approval Number	03866
Marine Approvals	LRS: 01/00172 (E3) DNV: E-13848 ABS: 14-LD234401A-4-PDA, BV: 43180/A1
Ingress Protection Rating**	IP66, IP67 & IP68***
Deluge Protection Compliance	DTS01 : 91
Cable Gland Material	Brass, Electroless Nickel Plated Brass, Stainless Steel, Aluminium
Seal Material	CMP SOLO LSF Halogen Free Thermoset Elastomer / RapidEx Barrier Compound
Cable Type	Lead Sheathed & Single Wire Armour (LC/SWA), Lead Sheathed & Aluminium Wire Armour (LC/AWA), Lead Sheathed & Wire Braid Armour (LC/SWB), Lead Sheathed & Pliable Wire Armour (LC/PWA), Lead Sheathed & Steel Tape Armour (LC/STA), Lead Sheathed & Aluminium Strip Armour (LC/ASA)
Armour Clamping	Detachable Compound Tube / Cone & AnyWay Universal Clamping Ring
Sealing Technique	Unique CMP 'LRS' Outer Seal (Load Retention Seal)
Sealing Area(s)	Inner Compound Barrier & Outer Sheath

* Mechanical & Electrical Classifications applied as per IEC 62444 & EN 62444

** When CMP installation accessories are used. Refer to page 7 or www.cmp-products.com for further information.

*** IP68 tested to a minimum depth of 30 metres for 12 hours, alternate depths / durations can be provided upon request

Cable Gland Selection Table

Refer to illustration at the top of the page.

Dimensions listed below are for metric cable glands only
Dimensions for alternative threads may vary, please see supplementary technical data sheet

Cable Gland Size	Available Entry Threads "C" (Alternate Metric Thread Lengths Available)					Number of Cores	Diameter Over Conductors "A"	Lead Sheath Diameter "G"		Overall Cable Diameter "B"		Armour Range †				Across Flats "D"	Across Corners "D"	Protrusion Length "F"	Combined Ordering Reference (*Brass Metric)			Shroud	Cable Gland Weight (Kgs)
	Standard		Option		Min			Max	Min	Max	Grooved Cone (X)		Stepped Cone (W)		Size				Type	Ordering Suffix			
	Metric	Thread Length (Metric "E")	NPT	Thread Length (NPT) "E"							Min	Max	Min	Max							Min		
20S16	M20	15.0	1/2"	19.9	3/4"	11	7.8	3.1	7.8	6.1	13.1	0.3	1.0	0.8	1.25	30.5	33.6	62.0	20S16	PX2KPBREX	1RA	PVC06	0.25
20S	M20	15.0	1/2"	19.9	3/4"	11	11.0	6.1	11.0	9.5	15.9	0.3	1.0	0.8	1.25	30.5	33.6	62.0	20S	PX2KPBREX	1RA	PVC06	0.23
20	M20	15.0	1/2"	19.9	3/4"	11	12.6	6.5	13.4	12.5	20.9	0.4	1.0	0.8	1.25	30.5	33.6	63.0	20	PX2KPBREX	1RA	PVC06	0.24
25S	M25	15.0	3/4"	20.2	1"	21	17.5	11.1	19.3	14.0	22.0	0.4	1.2	1.25	1.6	37.5	41.3	69.5	25S	PX2KPBREX	1RA	PVC09	0.37
25	M25	15.0	3/4"	20.2	1"	21	17.5	11.1	19.3	18.2	26.2	0.4	1.2	1.25	1.6	37.5	41.3	69.5	25	PX2KPBREX	1RA	PVC09	0.37
32	M32	15.0	1"	25.0	1 1/4"	38	23.6	17.0	25.5	23.7	33.9	0.4	1.2	1.6	2.0	46.0	50.6	75.0	32	PX2KPBREX	1RA	PVC11	0.57
40	M40	15.0	1 1/4"	25.6	1 1/2"	59	27.9	22.0	31.2	27.9	40.4	0.4	1.6	1.6	2.0	55.0	60.5	75.0	40	PX2KPBREX	1RA	PVC15	0.80
50S	M50	15.0	1 1/2"	26.1	2"	89	35.2	29.5	37.2	35.2	46.7	0.4	1.6	2.0	2.5	60.0	66.0	77.0	50S	PX2KPBREX	1RA	PVC18	0.90
50	M50	15.0	2"	26.9	2 1/2"	89	40.4	35.6	42.6	40.4	53.0	0.6	1.6	2.0	2.5	70.0	77.0	77.0	50	PX2KPBREX	1RA	PVC21	1.19
63S	M63	15.0	2"	26.9	2 1/2"	115	45.6	40.1	48.5	45.6	59.4	0.6	1.6	2.0	2.5	75.0	82.5	79.7	63S	PX2KPBREX	1RA	PVC23	1.41
63S	M63	15.0	2 1/2"	39.9	3"	115	53.7	47.2	54.2	54.6	65.8	0.6	1.6	2.0	2.5	80.0	88.0	80.3	63	PX2KPBREX	1RA	PVC25	1.44
75S	M75	15.0	2 1/2"	39.9	3"	140	59.0	52.8	60.2	59.0	72.0	0.6	1.6	2.0	2.5	90.0	99.0	86.8	75S	PX2KPBREX	1RA	PVC28	2.13
75	M75	15.0	3"	41.5	3 1/2"	140	64.2	59.1	65.2	66.7	78.4	0.6	1.6	2.5	3.0	100.0	110.0	88.3	75	PX2KPBREX	1RA	PVC30	2.57
90	M90	24.0	3 1/2"	42.8	4"	200	75.3	66.6	77.1	76.2	90.3	0.8	1.6	3.15	4.0	115.0	126.5	102.1	90	PX2KPBREX	1RA	PVC32	3.75
100	M100	24.0	3 1/2"	42.8	4"	200	85.6	76.0	88.1	86.1	101.4	0.8	1.6	3.15	4.0	127.0	139.7	114.0	100	PX2KPBREX	1RA	LSF33	4.87

*For material options add the following suffix to the Ordering Reference; Brass (no suffix required); Nickel Plated Brass '5'; 316 Grade Stainless Steel '4'; Copper Free Aluminium '1'
For NPT options add the following digits to the material suffix; 1/2" = 31; 3/4" = 32; 1" = 33; 1 1/4" = 34; 1 1/2" = 35; 2" = 36; 2 1/2" = 37; 3" = 38; 3 1/2" = 39; 4" = 310 (Brass requires prefix '0')

Examples: 32PX2KPBREX1RA534 = Nickel Plated Brass 1 1/4" NPT, 50SPX2KPBREX1RA035 = Brass 1 1/2" NPT, 25PX2KPBREX1RA432 = Stainless Steel 3/4" NPT, 20PX2KPBREX1RA5 = Nickel Plated Brass M20

Dimensions are displayed in millimetres unless otherwise stated

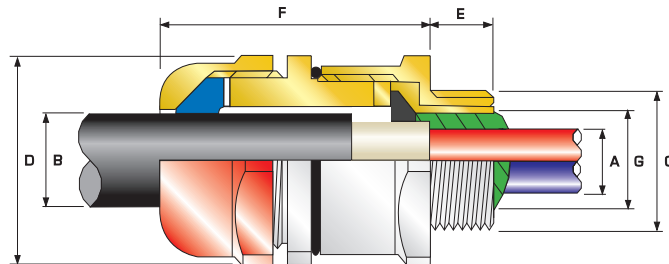
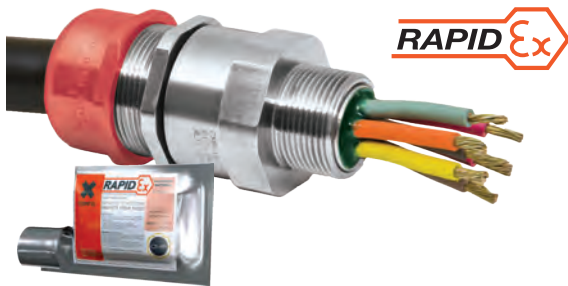

PXSS2KREX



PXSS2KREX Globally Approved, Explosive Atmosphere RapidEx Barrier Cable Gland

For all types of Unarmoured & Braid Cables

- RapidEx liquid pour sealing system
 - Enhances reliability, reduces risk
 - Reduces man hours
 - Reduces cost
- Direct & remote installation
- Superior levels of cable retention
- Displacement type environmental seal
- Deluge protected
- -60°C to +85°C
- Globally marked, IECEx, ATEX & cCSAus



TECHNICAL DATA

Design Specification	BS 6121:Part 1:1989, IEC 62444, EN 62444
Mechanical Classifications*	Impact = Level 8, Cable Anchorage = Class B
Enclosure Protection	IK10 to IEC 62262 (20 joules) Brass & Stainless Steel only
ATEX Certificate	SIRA13ATEX1072X, SIRA13ATEX4078X
Code of Protection	Ⓜ II 2G, II 1D, Ex d IIC Gb, Ex e IIC Gb, Ex ta IIIC Da Ⓜ II 3G Ex nR IIC Gc, Ⓜ IM2 Ex d I Mb, Ex e I Mb
Compliance Standards	EN 60079-0,1,7,15,31
IECEx Certificate	IECEx SIR 13.0027X, IECEx SIM 14.0008X
Code of Protection	Ex d IIC Gb, Ex e IIC Gb, Ex nR IIC Gc, Ex ta IIIC Da, Ex d I Mb, Ex e I Mb
Compliance Standards	IEC 60079-0,1,7,15,31
cCSAus Certificate (20S16 - 100)	2288626
CSAus Code of Protection***	Class I, Div. 1, 2 Groups A, B, C and D; Class II, Div. 1, 2 Groups E, F and G; Class III, Div. 1, 2; Type 4X: Oil Resistant II: Class I, Zone 1 AEx d IIC Gb, AEx e IIC Gb, Class I, Zone 2 AEx nR IIC Gc, Class I, Zone 20 AEx ta IIIC Da
cCSA Code of Protection***	Class I, Div. 1, 2 Groups A, B, C and D; Class II, Div. 1, 2 Groups E, F and G; Class III, Div. 1, 2; Type 4X: Oil Resistant II: Ex d IIC Gb, Ex e IIC Gb, Ex nR IIC Gc, Ex ta IIIC Da
Compliance Standards	CAN/CSA-C22.2 No 0,18,25,30,94,174, CAN/CSA-E60079-0,1,7,31 CAN CSA-E6124111, Part 11, ANSI/UL 514B Ed 5, ANSI/UL 50 Ed 11, ANSI/UL 2225 Ed 4, UL60079-0:07
EAC Certificate	TC RU C-GB.F605.B00138
UkrSEPRO	UA.TR.047.C.0644-15
CCOE / PESO (India) Certificate	P333688
NEPSI Certificate	GYJ13.1140X / GYJ13.1282X
INMETRO Approval	TÜV 12.2073X
RETIE Approval Number	03866
Marine Approvals	LRS: 01/00172 (E3) DNV: E-13848 ABS: 14-LD234401A-4-PDA, BV: 43180/A1
Ingress Protection Rating**	IP66, IP67 & IP68
Deluge Protection Compliance	DTS01 : 91
Cable Gland Material	Electroless Nickel Plated Brass, Brass, Stainless Steel, Aluminium
Seal Material	CMP SOLO LSF Halogen Free Thermoset Elastomer / RapidEx Barrier Compound
Cable Type	Unarmoured***
Sealing Technique	Unique CMP 'LRS' Outer Seal (Load Retention Seal)
Sealing Area(s)	RapidEx Resin Barrier & Cable Outer Sheath

* Mechanical & Electrical Classifications applied as per IEC 62444 & EN 62444
 ** When CMP installation accessories are used. Refer to page 7 or www.cmp-products.com for further information.
 *** Where the cable is permitted by code (NEC and/or CEC)
 **** IP68 tested to a minimum depth of 30 metres for 12 hours, alternate depths / durations can be provided upon request

Cable Gland Selection Table

Refer to illustration at the top of the page.

Dimensions listed below are for metric cable glands only
 Dimensions for alternative threads may vary, please see supplementary technical data sheet

Cable Gland Size	Available Entry Threads "C" (Alternate Metric Thread Lengths Available)					Number of Cores	Diameter Over Conductors "A"	Cable Bedding Diameter "G"	Overall Cable Diameter "B"		Across Flats "D"	Across Corners "D"	Protrusion Length "F"	Combined Ordering Reference (*Brass Metric)			Shroud	Cable Gland Weight (Kgs)				
	Standard		Option						Max	Min				Max	Max	Max			Max	Size	Type	Ordering Suffix
	Metric	Thread Length (Metric) "E"	NPT	Thread Length (NPT) "E"	NPT																	
20S16	M20	15.0	1/2"	19.9	3/4"	11	8.6	8.6	3.1	8.6	30.0	33.0	53.1	20S16	PXSS2KREX	1RA	PVC06	0.200				
20S	M20	15.0	1/2"	19.9	3/4"	11	11.7	11.7	6.1	11.7	30.0	33.0	53.1	20S	PXSS2KREX	1RA	PVC06	0.200				
20	M20	15.0	1/2"	19.9	3/4"	11	12.6	12.9	6.5	14.0	30.0	33.0	54.2	20	PXSS2KREX	1RA	PVC06	0.200				
20L	M20	15.0	1/2"	19.9	3/4"	11	12.6	12.9	10.0	15.9	30.0	33.0	54.2	20L	PXSS2KREX	1RA	PVC06	0.200				
25	M25	15.0	3/4"	20.2	1"	21	17.5	17.9	11.1	20.0	36.0	39.6	60.0	25	PXSS2KREX	1RA	PVC09	0.330				
32	M32	15.0	1"	25.0	1 1/4"	38	23.6	23.9	17.0	26.3	41.0	45.1	61.1	32	PXSS2KREX	1RA	PVC10	0.590				
32L	M32	15.0	1"	25.0	1 1/4"	38	23.6	23.9	20.0	27.4	41.0	45.1	61.1	32L	PXSS2KREX	1RA	PVC10	0.590				
40	M40	15.0	1 1/4"	25.6	1 1/2"	59	30.0	30.3	22.0	32.1	50.0	55.0	62.4	40	PXSS2KREX	1RA	PVC13	0.560				
50S	M50	15.0	1 1/2"	26.1	2"	89	36.6	36.9	29.5	38.2	55.0	60.5	65.2	50S	PXSS2KREX	1RA	PVC15	0.660				
50	M50	15.0	2"	26.9	2 1/2"	89	41.0	41.3	35.6	44.0	60.0	66.0	67.6	50	PXSS2KREX	1RA	PVC18	0.730				
63S	M63	15.0	2"	26.9	2 1/2"	115	47.9	48.4	40.1	49.9	70.0	77.0	71.1	63S	PXSS2KREX	1RA	PVC21	1.070				
63	M63	15.0	2 1/2"	39.9	3"	115	53.7	54.0	47.2	55.9	75.0	82.5	70.4	63	PXSS2KREX	1RA	PVC23	1.060				
75S	M75	15.0	2 1/2"	39.9	3"	140	59.9	60.2	52.8	61.9	80.0	88.0	75.3	75S	PXSS2KREX	1RA	PVC25	1.300				
75	M75	15.0	3"	41.5	3 1/2"	140	64.3	64.2	59.1	67.9	85.0	93.5	74.9	75	PXSS2KREX	1RA	PVC27	1.300				
90	M90	24.0	3 1/2"	42.8	4"	200	75.3	75.6	66.6	79.4	108.0	118.8	94.8	90	PXSS2KREX	1RA	PVC31	3.020				
100	M100	24.0	3 1/2"	42.8	4"	200	85.6	85.9	76.0	90.9	123.0	135.3	86.3	100	PXSS2KREX	1RA	LSF33	4.000				

*For material options add the following suffix to the Ordering Reference; Brass (no suffix required); Nickel Plated Brass 'S'; 316 Grade Stainless Steel '4'; Copper Free Aluminium '1'
 For NPT options add the following digits to the material suffix; 1/2" = 31; 3/4" = 32; 1" = 33; 1 1/4" = 34; 1 1/2" = 35; 2" = 36; 2 1/2" = 37; 3" = 38; 3 1/2" = 39; 4" = 310 (Brass requires prefix '0')
 Examples: 32PXSS2KREX1RA534 = Nickel Plated Brass 1 1/4" NPT, 50SPXSS2KREX1RA035 = Brass 1 1/2" NPT, 25PXSS2KREX1RA432 = Stainless Steel 3/4" NPT, 20PXSS2KREX1RA5 Nickel Plated Brass M20

Dimensions are displayed in millimetres unless otherwise stated

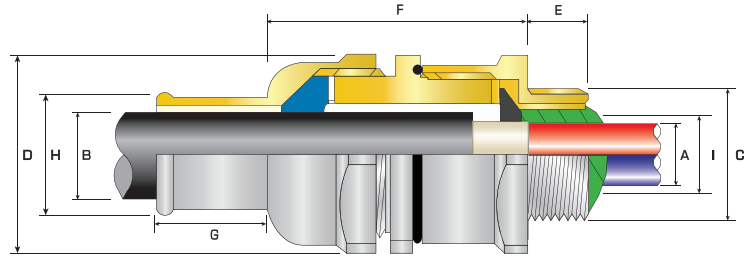
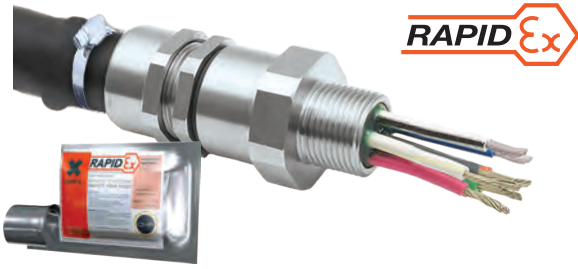

PXSS2KHCREX



PXSS2KHCREX Globally Approved, Explosive Atmosphere RapidEx Barrier Cable Gland

For all types of Unarmoured & Braided cables housed in Flexible Hose

- RapidEx liquid pour sealing system
 - Enhances reliability, reduces risk
 - Reduces man hours
 - Reduces cost
- Direct & remote installation
- Superior levels of cable retention
- Displacement type environmental seal
- Deluge protected
- -60°C to +85°C
- Globally marked, IECEx, ATEX & cCSAus



Epoxy compound version also available

Available for Group I & II use

TECHNICAL DATA

Design Specification	BS 6121:Part 1:1989, IEC 62444, EN 62444
Mechanical Classifications*	Impact = Level 8, Cable Anchorage = Class B
Enclosure Protection	IK10 to IEC 62262 (20 joules) Brass & Stainless Steel only
ATEX Certificate	SIRA13ATEX1072X, SIRA13ATEX4078X
Code of Protection	⊕ II 2G, II 1D, Ex d IIC Gb, Ex e IIC Gb, Ex ta IIIC Da ⊕ II 3G Ex nR IIC Gc, ⊕ IM2 Ex d I Mb, Ex e I Mb
Compliance Standards	EN 60079-0,1,7,15,31
IECEx Certificate	IECEx SIR 13.0027X, IECEx SIM 14.0008X
Code of Protection	Ex d IIC Gb, Ex e IIC Gb, Ex nR IIC Gc, Ex ta IIIC Da, Ex d I Mb, Ex e I Mb
Compliance Standards	IEC 60079-0,1,7,15,31
EAC Certificate	TC RU C-GB.ГB05.В00138
CCOE / PESO (India) Certificate	P333688
NEPSI Certificate	GYJ13.1140X / GYJ13.1282X
INMETRO Approval	TÜV 12.2073X
RETIE Approval Number	03866
Marine Approvals	LRS: 01/00172 ABS: 01LD234401A/3-PDA
Ingress Protection Rating**	IP66, IP67 & IP68***
Deluge Protection Compliance	DTS01 : 91
Cable Gland Material	Electroless Nickel Plated Brass, Brass, Stainless Steel, Aluminium
Seal Material	CMP SOLO LSF Halogen Free Thermoset Elastomer / RapidEx Barrier Compound
Cable Type	Unarmoured
Armour Clamping	Detachable Resin Tube / Cone & AnyWay Universal Clamping Ring
Sealing Technique	Unique CMP 'LRS' Outer Seal (Load Retention Seal)
Sealing Area(s)	RapidEx Resin Barrier & Cable Outer Sheath

* Mechanical & Electrical Classifications applied as per IEC 62444 & EN 62444

** When CMP installation accessories are used. Refer to page 7 or www.cmp-products.com for further information.

*** IP68 tested to a minimum depth of 30 metres for 12 hours, alternate depths / durations can be provided upon request

Cable Gland Selection Table

Refer to illustration at the top of the page.

Dimensions listed below are for metric cable glands only
Dimensions for alternative threads may vary, please see supplementary technical data sheet

Cable Gland Size	Minimum Entry Thread (Metric) "C"	Minimum Thread Length "E"	Diameter Over Conductors "A"	Max Number Of Cores	Overall Cable Diameter "B"		Nominal Hose Bore Ø "H"	Across Flats "D"	Across Corners "D"	Nominal * Protusion Length Without Hose Connection "F"	Hose Connection Length "G"	Overall Length "E" + "F" + "G" *	Combined Ordering Reference (**Brass Metric)			Shroud	Cable Gland Weight (Kgs)
					Min	Max							Size	Type	Ordering Suffix		
20S16	M20	15.0	8.6	11	3.1	8.6	13.0	30.0	33.0	51.1	16.0	82.5	20S16	PXSS2KREXHC13	1RA	PVC06	0.220
20S16	M20	15.0	8.6	11	3.1	8.6	16.0	30.0	33.0	51.1	16.0	82.5	20S16	PXSS2KREXHC16	1RA	PVC06	0.220
20S	M20	15.0	11.7	11	6.1	11.7	16.0	30.0	33.0	49.3	16.0	82.5	20S	PXSS2KREXHC16	1RA	PVC06	0.220
20	M20	15.0	12.6	11	6.5	14.0	19.0	30.0	33.0	50.0	20.0	86.9	20	PXSS2KREXHC19	1RA	PVC06	0.220
25	M25	15.0	17.5	21	11.1	20.0	25.0	36.0	39.6	55.3	27.0	98.8	25	PXSS2KREXHC25	1RA	PVC09	0.360
32	M32	15.0	23.6	38	17.0	26.3	32.0	41.0	45.1	55.6	33.0	105.2	32	PXSS2KREXHC32	1RA	PVC10	0.450
40	M40	15.0	30.0	59	22.0	32.1	38.0	50.0	55.0	56.3	41.0	114.1	40	PXSS2KREXHC38	1RA	PVC13	0.650
50S	M50	15.0	36.6	89	29.5	38.2	51.0	60.0	66.0	57.3	54.0	128.5	50S	PXSS2KREXHC51	1RA	PVC18	1.070
50	M50	15.0	41.0	89	35.6	44.0	51.0	60.0	66.0	62.2	54.0	132.1	50	PXSS2KREXHC51	1RA	PVC18	0.950
63S	M63	15.0	47.9	115	40.1	49.9	63.0	70.1	77.1	63.0	70.0	150.1	63S	PXSS2KREXHC63	1RA	PVC21	1.730
63	M63	15.0	53.7	115	47.2	55.9	63.0	75.0	82.5	65.0	70.0	152.6	63	PXSS2KREXHC63	1RA	PVC23	1.430
75S	M75	15.0	59.9	140	52.8	61.9	76.0	80.4	88.4	65.6	91.5	174.6	75S	PXSS2KREXHC76	1RA	PVC26	2.500
75	M75	15.0	64.3	140	59.1	67.9	76.0	85.0	93.5	63.7	91.5	177.4	75	PXSS2KREXHC76	1RA	PVC27	1.960

*The protrusion and overall lengths stated will vary after installation, depending upon the overall cable diameter.

**For material options add the following suffix to the Ordering Reference; Brass (no suffix required); Nickel Plated Brass '5'; 316 Grade Stainless Steel '4'; Copper Free Aluminium '1'

Examples: 50SPXSS2KREXHC511RA5 = Nickel Plated Brass 50mm, 25PXSS2KREXHC251RA4 = Stainless Steel M25

Dimensions are displayed in millimetres unless otherwise stated



RAPID Ex

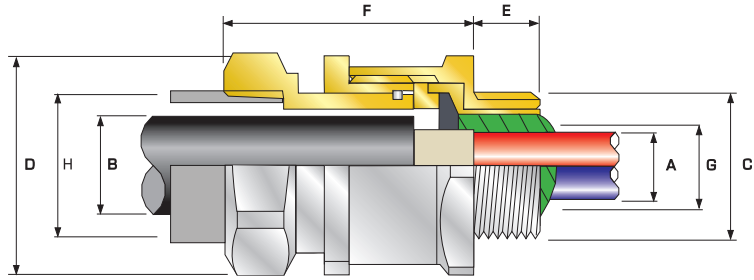

PXRCREX



PXRCREX Globally Approved, Explosive Atmosphere RapidEx Barrier Cable Gland

For all types of Unarmoured & Braid Cables housed in Conduit

- RapidEx liquid pour sealing system
 - Enhances reliability, reduces risk
 - Reduces man hours
 - Reduces cost
- Designed for rigid & flexible conduits
- Easy install running coupler design
- Compound barrier type flameproof seal
- -60°C to +85°C
- Internationally marked, IECEx & ATEX



Alternative conduit sizes available upon request.

See cable gland selection table below for full NPT & Metric thread ordering references

THREAD OPTION ORDERING EXAMPLES

Ordering Reference	Male Thread	Female Thread
20PXRCREX1RA	M20	M20
20PXRCREX1RA031	M20	½" NPT
20PXRCREX1RA03131	½" NPT	½" NPT
20PXRCREX1RA03102*	½" NPT	M20

Refer to 'How to order' page for complete list of ordering codes.
 * For Metric female threads please insert '0' before thread size code
 e.g. 32PXRCREX1RA53405 (1 ¼" NPT Male x M40 Female)

TECHNICAL DATA

Design Specification	BS 6121:Part 1:1989, IEC 62444, EN 62444
Mechanical Classifications*	Impact = Level 8, Cable Anchorage = Class B
Enclosure Protection	IK10 to IEC 62262 (20 joules) Brass & Stainless Steel only
ATEX Certificate	SIRA13ATEX1072X
Code of Protection	⊕ II 2G, II 1D, Ex d IIC Gb, Ex e IIC Gb, Ex ta IIIC Da
Compliance Standards	EN 60079-0,1,7,31
IECEx Certificate	IECEx SIR 13.0027X, IECEx SIM 14.0008X
Code of Protection	Ex d IIC Gb, Ex e IIC Gb, Ex ta IIIC Da
Compliance Standards	IEC 60079-0,1,7,31
NEPSI Certificate	GYJ13.1140X / GYJ13.1282X
INMETRO Approval	TÜV 12.2073X
EAC Certificate	TC RU C-GB.ГБ05.В.01271
UkrSEPRO	UA.TR.047.C.0644-15
CCOE / PESO (India) Certificate	P333688
RETIE Approval Number	03866
Marine Approvals	LRS: 01/00172 (E3) DNV: E-13848 ABS: 14-LD234401A-4-PDA
Ingress Protection Rating**	IP66
Cable Gland Material	Brass, Electroless Nickel Plated Brass, Aluminium, Stainless Steel
Seal Material	RapidEx Barrier Compound
Cable Type	Unarmoured
Sealing Area(s)	RapidEx Resin Barrier

* Mechanical & Electrical Classifications applied as per IEC 62444 & EN 62444
 ** When CMP installation accessories are used. Refer to page 7 or www.cmp-products.com for further information.

Cable Gland Selection Table

Refer to illustration at the top of the page.

Dimensions listed below are for metric cable glands only
 Dimensions for alternative threads may vary, please see supplementary technical data sheet

Cable Gland Size	Available Entry Threads "C" (Alternate Metric Thread Lengths Available)					Max Number Of Cores	Standard Female Connection Thread "H"	Diameter Over Conductors "A"	Cable Bedding Diameter "G"	Overall Cable Diameter "B"	Across Flats "D"	Across Corners "D"	Protrusion Length "F"	Combined Ordering Reference (*Brass Metric)			Shroud	Cable Gland Weight (Kgs)
	Standard		Option		Size									Type	Ordering Suffix			
	Metric	Thread Length (Metric) "E"	NPT	Thread Length (NPT) "E"														
20	M20	15.0	½"	19.9	¾"	11	M20	12.6	12.9	13.9	30.0	33.0	45.9	20	PXRCREX	1RA	PVC06	0.170
25	M25	15.0	¾"	20.2	1"	21	M25	17.5	17.9	19.9	41.0	45.1	53.6	25	PXRCREX	1RA	PVC09	0.330
32	M32	15.0	1"	25.0	1 ¼"	38	M32	23.6	23.9	26.2	41.0	45.1	51.8	32	PXRCREX	1RA	PVC10	0.320
40	M40	15.0	1 ¼"	25.6	1 ½"	59	M40	30.0	30.3	32.3	50.0	55.0	48.6	40	PXRCREX	1RA	PVC13	0.420
50S	M50	15.0	1 ½"	26.1	2"	89	M50	36.6	36.9	38.9	55.0	60.5	59.1	50S	PXRCREX	1RA	PVC15	0.570
50	M50	15.0	2"	26.9	2 ½"	89	M50	41.0	41.3	44.2	60.0	66.0	64.0	50	PXRCREX	1RA	PVC18	0.610
63S	M63	15.0	2"	26.9	2 ½"	115	M63	47.9	48.4	50.0	70.1	77.1	62.6	63S	PXRCREX	1RA	PVC21	0.940
63	M63	15.0	2 ½"	39.9	3"	115	M63	53.7	54.0	58.0	75.0	82.5	64.6	63	PXRCREX	1RA	PVC23	0.890
75S	M75	15.0	2 ½"	39.9	3"	140	M75	59.9	60.2	62.4	84.0	92.4	71.7	75S	PXRCREX	1RA	PVC27	1.290
75	M75	15.0	3"	41.5	3 ½"	140	M75	64.3	64.2	68.1	85.0	93.5	71.2	75	PXRCREX	1RA	PVC27	1.160
90	M90	24.0	3 ½"	42.8	4"	200	M90	75.3	75.6	80.1	108.0	118.8	87.3	90	PXRCREX	1RA	PVC31	2.630

*For material options add the following suffix to the Ordering Reference; Brass (no suffix required); Nickel Plated Brass '5'; 316 Grade Stainless Steel '4'; Copper Free Aluminium '1'
 For NPT male and / or female options please add the following digits to the material suffix (See Thread Options table above); ½" = 31, ¾" = 32, 1" = 33, 1 ¼" = 34, 1 ½" = 35, 2" = 36, 2 ½" = 37, 3" = 38, 3 ½" = 39, 4" = 310 (Brass requires prefix "0")
 When NPT male & Metric female product option is required, please add the following digits to the material and NPT male suffix (See Thread Options table above); M20 = 02, M25 = 03, M32 = 04, M40 = 05, M50 = 06, M63 = 07, M75 = 08, M90 = 09 (Brass requires prefix "0")
 Examples: 32PXRCREX1RA533 = Nickel Plated Brass M32 male x 1" NPT female, 20S16PXRCREX1RA031 = Brass M20 male x ½" NPT female, 25PXRCREX1RA43202 = Stainless Steel ¾" NPT male x M25 female, 20PXRCREX1RA5 = Nickel Plated Brass M20 male & female

Dimensions are displayed in millimetres unless otherwise stated



CMP EXPLOSIVE ATMOSPHERE BARRIER PRODUCTS





Explosive Atmosphere Compound Barrier Cable Glands

CMP Barrier Cable Glands are generally used for two different applications in the IEC world. Barrier Cable Glands may either be required to prevent gas, vapour or fluid from migrating through a cable, or prevent flame transmission from a Flameproof type 'd' enclosure, as determined by IEC 60079-14.

The compound barrier seal is made on site by the technician completing the installation and is used primarily in explosive atmospheres, as required by the installation code

All Cable Glands shown in Nickel Plated Brass, alternative materials are available.



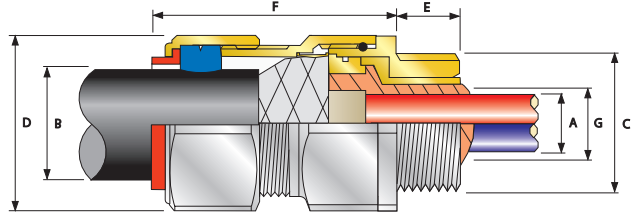

PX2K



PX2K Globally Approved, Explosive Atmosphere Barrier Cable Gland

For all types of Armoured cables

- Metal-to-metal armour clamping
- Direct & remote installation
- Compound barrier type flameproof seal
- Controlled outer 'load retention' seal
- Unique OSTG prevents overtightening
- Integral protected deluge seal
- -60°C to +85°C
- Globally marked, IECEx, ATEX, UL & cCSAus
- Superior EMC performance



† Grooved Cone (X) is predominantly used for Wire Braid (e.g. GSWB, TCWB), Steel Tape Armour (STA, DSTA) and Aluminium Strip Armour (ASA) but is also suitable for Single Wire Armour (SWA), Aluminium Wire Armour (AWA) and Pliable Wire Armour (PWA) if the range is outside that of the Stepped Cone (W).

Grooved Cone (X) dimensions shown in the Cable Gland Selection Table below are for a double wire strand of braid armour cables. Tapes can also be doubled over. For cables that have only a single layer of armour such as SWA the clamping range should be used as shown in the table below.

Stepped (W) Cone is suitable for Single Wire Armour (SWA), or Aluminium Wire Armour (AWA) cables.

TECHNICAL DATA	
Design Specification	BS 6121:Part 1:1989, IEC 62444, EN 62444
Mechanical Classifications*	Impact = Level 8, Cable Anchorage = Class D
Enclosure Protection	IK10 to IEC 62262 (20 joules) Brass & Stainless Steel only
Electrical Classifications*	Category B (Category A when used with braid, tape or pliable wire armour cables)
ATEX Certificate	SIRA13ATEX1072X, SIRA13ATEX4078X
Code of Protection	⊕ II 2G, II 1D, Ex d IIC Gb, Ex e IIC Gb, Ex ta IIIC Da ⊕ II 3G Ex nR IIC Gc, ⊕ IM2 Ex d I Mb, Ex e I Mb
Compliance Standards	EN 60079-0,1,7,15,31
IECEx Certificate	IECEx SIR 13.0027X, IECEx SIM 14.0008X
Code of Protection	Ex d IIC Gb, Ex e IIC Gb, Ex nR IIC Gc, Ex ta IIIC Da, Ex d I Mb, Ex e I Mb
Compliance Standards	IEC 60079-0,1,7,15,31
cCSAus Certificate (20S16 - 100)	2288626
CSAus Code of Protection***	Class I, Div. 1, 2 Groups A, B, C and D; Class II, Div. 1, 2 Groups E, F and G; Class III, Div. 1, 2; Type 4X: Oil Resistant II: Class I, Zone 1 AEx d IIC Gb, AEx e IIC Gb, Class I, Zone 2 AEx nR IIC Gc, Class I, Zone 20 AEx ta IIIC Da
cCSA Code of Protection***	Class I, Div. 1, 2 Groups A, B, C and D; Class II, Div. 1, 2 Groups E, F and G; Class III, Div. 1, 2; Type 4X: Oil Resistant II: Ex d IIC Gb, Ex e IIC Gb, Ex nR IIC Gc, Ex ta IIIC Da
Compliance Standards	CAN/CSA-C22.2 No 0,18,25,30,94,174, CAN/CSA-E60079-0,1,7,15,31 CAN/CSA-E6124111 Part 11, ANSI/UL 514B Ed 5, ANSI/UL 50 Ed 11, ANSI/UL 2225 Ed 4, UL60079 E201187, E161256C
UL Certificate (20S16 -100)	E201187, E161256C
Code of Protection	Class I Div 1,2, Groups A,B,C,D, Class II Div 1,2, Groups E,F,G
Compliance Standards	UL 2225, CSA C22.2 No 174, UL 514B, CSA C22.2 No 18, CSA C22.2 No 30
EAC Certificate	TC RU C-GB.ГБ05.В00138
UKrSEPRO	UA.TR.047.C.0644-15
KCS Certificate	14-GA480-0252X
CCOE / PESO (India) Certificate	P333688
NEPSI Certificate	GYJ13.1140X / GYJ13.1282X
INMETRO Approval	TUV 12.2073X
RETIE Approval Number	03866
Marine Approvals	LRS: 01/00172 (E3) DNV: E-13848 ABS: 14-LD234401A-4-PDA, BV: 43180/A1
Ingress Protection Rating**	IP66, IP67 & IP68****
Deluge Protection Compliance	DTS01 : 91
Cable Gland Material	Brass, Electroless Nickel Plated Brass, Stainless Steel, Aluminium
Seal Material	CMP SOLO LSF Halogen Free Thermoset Elastomer / Epoxy Barrier Compound
Cable Type	Single Wire Armour (SWA), Aluminium Wire Armour (AWA), Wire Braid Armour (e.g. SWB), Screened Flexible (EMC) Wire Braid (e.g. CY / SY), Pliable Wire Armour (PWA), Steel Tape Armour (STA), Strip Armour (e.g. ASA)***
Armour Clamping	Detachable Compound Tube / Cone & AnyWay Universal Clamping Ring
Sealing Technique	Unique CMP 'LRS' Outer Seal (Load Retention Seal)
Sealing Area(s)	Inner Compound Barrier & Outer Sheath

* Mechanical & Electrical Classifications applied as per IEC 62444 & EN 62444

** When CMP installation accessories are used. Refer to page 7 or www.cmp-products.com for further information.

***Where the cable is permitted by code (NEC and/or CEC)

**** IP68 tested to a minimum depth of 30 metres for 12 hours, alternate depths / durations can be provided upon request

Cable Gland Selection Table

Refer to illustration at the top of the page.

Dimensions listed below are for metric cable glands only
Dimensions for alternative threads may vary, please see supplementary technical data sheet

Cable Gland Size	Available Entry Threads "C" (Alternate Metric Thread Lengths Available)					Number of Cores	Diameter Over Conductors "A"	Cable Bedding Diameter "G"	Overall Cable Diameter "B"			Armour Range †				Across Flats "D"	Across Corners "D"	Protusion Length "F"	Combined Ordering Reference (*Brass Metric)			Shroud	Cable Gland Weight (Kgs)
	Standard		Option						Max	Min	Max	Grooved Cone (X)		Stepped Cone (W)					Size	Type	Ordering Suffix		
	Metric	Thread Length (Metric) "E"	NPT	Thread Length (NPT) "E"	NPT							Max	Min	Max	Min								
20S16	M20	15.0	1/2"	19.9	3/4"	11	11.7	11.7	6.1	13.1	0.3	1.0	0.8	1.25	30.5	33.6	62.0	20S16	PX2K	1RA	PVC06	0.24	
20S	M20	15.0	1/2"	19.9	3/4"	11	11.7	11.7	9.5	15.9	0.3	1.0	0.8	1.25	30.5	33.6	62.0	20S	PX2K	1RA	PVC06	0.23	
20	M20	15.0	1/2"	19.9	3/4"	11	12.6	12.9	12.5	20.9	0.4	1.0	0.8	1.25	30.5	33.6	63.0	20	PX2K	1RA	PVC06	0.24	
25S	M25	15.0	3/4"	20.2	1"	21	17.5	17.9	14.0	22.0	0.4	1.2	1.25	1.6	37.5	41.3	69.5	25S	PX2K	1RA	PVC09	0.37	
25	M25	15.0	3/4"	20.2	1"	21	17.5	17.9	18.2	26.2	0.4	1.2	1.25	1.6	37.5	41.3	69.5	25	PX2K	1RA	PVC09	0.37	
32	M32	15.0	1"	25.0	1 1/4"	38	23.6	23.9	23.7	33.9	0.4	1.2	1.6	2.0	46.0	50.6	75.0	32	PX2K	1RA	PVC11	0.57	
40	M40	15.0	1 1/4"	25.6	1 1/2"	59	30.0	30.3	27.9	40.4	0.4	1.6	1.6	2.0	55.0	60.5	75.0	40	PX2K	1RA	PVC15	0.80	
50S	M50	15.0	1 1/2"	26.1	2"	89	36.6	36.9	35.2	46.7	0.4	1.6	2.0	2.5	60.0	66.0	77.0	50S	PX2K	1RA	PVC18	0.90	
50	M50	15.0	2"	26.9	2 1/2"	89	41.0	41.3	40.4	53.0	0.6	1.6	2.0	2.5	70.0	77.0	77.0	50	PX2K	1RA	PVC21	1.19	
63S	M63	15.0	2"	26.9	2 1/2"	115	47.9	48.4	45.6	59.4	0.6	1.6	2.0	2.5	75.0	82.5	79.7	63S	PX2K	1RA	PVC23	1.39	
63	M63	15.0	2 1/2"	39.9	3"	115	53.7	54.0	54.6	65.8	0.6	1.6	2.0	2.5	80.0	88.0	80.3	63	PX2K	1RA	PVC25	1.41	
75S	M75	15.0	2 1/2"	39.9	3"	140	59.9	60.2	59.0	72.0	0.6	1.6	2.0	2.5	90.0	99.0	86.8	75S	PX2K	1RA	PVC28	2.09	
75	M75	15.0	3"	41.5	3 1/2"	140	64.2	64.2	66.7	78.4	0.6	1.6	2.5	3.0	100.0	110.0	88.3	75	PX2K	1RA	PVC30	2.54	
90	M90	24.0	3 1/2"	42.8	4"	200	75.3	75.6	76.2	90.3	0.8	1.6	3.15	4.0	115.0	126.5	102.1	90	PX2K	1RA	PVC32	3.71	
100	M100	24.0	3 1/2"	42.8	4"	200	85.6	85.9	86.1	101.4	0.8	1.6	3.15	4.0	127.0	139.7	114.0	100	PX2K	1RA	LSF33	4.31	

*For material options add the following suffix to the Ordering Reference; Brass (no suffix required), Nickel Plated Brass '5', 316 Grade Stainless Steel '4', Copper Free Aluminium '1' For NPT options add the following digits to the material suffix; 1/2" = 31; 3/4" = 32; 1" = 33; 1 1/4" = 34; 1 1/2" = 35; 2" = 36; 2 1/2" = 37; 3" = 38; 3 1/2" = 39; 4" = 310 (Brass requires prefix '0')

Examples: 32PX2K1RA534 = Nickel Plated Brass 1 1/4" NPT, 50SPX2K1RA035 = Brass 1 1/2" NPT, 25PX2K1RA432 = Stainless Steel 3/4" NPT, 20PX2K1RA5 = Nickel Plated Brass M20

Dimensions are displayed in millimetres unless otherwise stated

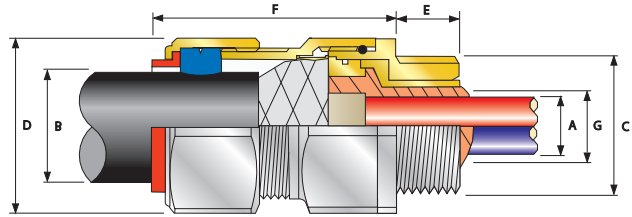

PX2KX



PX2KX Globally Approved, Explosive Atmosphere Barrier Cable Gland

For all types of Braided & Tape Armoured Cables

- Metal-to-metal armour clamping
- Direct & remote installation
- Compound barrier type flameproof seal
- Controlled outer 'load retention' seal
- Unique OSTG prevents overtightening
- Integral protected deluge seal
- -60°C to +85°C
- Globally marked, IECEx, ATEX, UL & cCSAus
- Superior EMC performance



† Grooved Cone (X) is predominantly used for Wire Braid (e.g. GSWB, TCWB), Steel Tape Armour (STA, DSTA) and Aluminium Strip Armour (ASA) but is also suitable for Single Wire Armour (SWA), Aluminium Wire Armour (AWA) and Pliable Wire Armour (PWA) if the range is outside that of the Stepped Cone (W).

Grooved Cone (X) dimensions shown in the Cable Gland Selection Table below are for a double wire strand of braid armour cables. Tapes can also be doubled over. For cables that have only a single layer of armour such as SWA the clamping range should be used as shown in the table below.

TECHNICAL DATA	
Design Specification	BS 6121:Part 1:1989, IEC 62444, EN 62444
Mechanical Classifications*	Impact = Level 8, Cable Anchorage = Class B
Enclosure Protection	IK10 to IEC 62262 (20 joules) Brass & Stainless Steel only
Electrical Classifications*	Category B (Category A when used with braid, tape or pliable wire armour cables)
ATEX Certificate	SIRA13ATEX1072X, SIRA13ATEX4078X
Code of Protection	Ⓜ II 2G, II 1D, Ex d IIC Gb, Ex e IIC Gb, Ex ta IIIC Da, Ⓜ II 3G Ex nR IIC Gc, Ⓜ IM2 Ex d I Mb, Ex e I Mb
Compliance Standards	EN 60079-0,1,7,15,31
IECEx Certificate	IECEx SIR 13.0027X, IECEx SIM 14.0008X
Code of Protection	Ex d IIC Gb, Ex e IIC Gb, Ex nR IIC Gc, Ex ta IIIC Da, Ex d I, Ex e I
Compliance Standards	IEC 60079-0,1,7,15,31
cCSAus Certificate (20S16 - 100)	2288626
CSAus Code of Protection***	Class I, Div. 1, 2 Groups A, B, C and D; Class II, Div. 1, 2 Groups E, F and G; Class III, Div. 1, 2; Type 4X: Oil Resistant II: Class I, Zone 1 AEx d IIC Gb, AEx e IIC Gb, Class I, Zone 2 AEx nR IIC Gc, Class I, Zone 20 AEx ta IIIC Da
CSA Code of Protection***	Class I, Div. 1, 2 Groups A, B, C and D; Class II, Div. 1, 2 Groups E, F and G; Class III, Div. 1, 2; Type 4X: Oil Resistant II: Ex d IIC Gb, Ex e IIC Gb, Ex nR IIC Gc, Ex ta IIIC Da
Compliance Standards	CAN/CSA-C22.2 No 0,18,25,30,94,174, CAN/CSA-E60079-0,1,7,15,31 CAN/CSA-E612411 Part 11, ANSI/UL 514B Ed 5, ANSI/UL 50 Ed 11, ANSI/UL 2225 Ed 4, UL60079
UL Certificate (20S16 - 100)	E201187, E161256C
Code of Protection	Class I Div 1,2, Groups A,B,C,D, Class II Div 1,2, Groups E,F,G
Compliance Standards	UL 2225, CSA C22.2 No 174, UK 514B, CSA C22.2 No 18, CSA C22.2 No 30
EAC Certificate	TC RU C-GB.F605.B00138
UkrSEPRO	UA.TR.047.C.0644-15
KCS Certificate	14-GA4B0-0252X
CCOE / PESO (India) Certificate	P333688
NEPSI Certificate	GYJ13.1140X / GYJ13.1282X
INMETRO Approval	TUV 12.2073X
RETIE Approval Number	03866
Marine Approvals	LRS: 01/00172 (E3) DNV: E-13848 ABS: 14-LD234401A-4-PDA, BV: 43180/A1
Ingress Protection Rating**	IP66, IP67 & IP68****
Deluge Protection Compliance	DTS01 : 91
Cable Gland Material	Electroless Nickel Plated Brass, Brass, Stainless Steel, Aluminium
Seal Material	CMP SOLO LSF Halogen Free Thermoset Elastomer / Epoxy Barrier Compound
Cable Type	Screened Flexible (EMC) Wire Braid (e.g. CY / SY), Pliable Wire Armour (PWA), Steel Tape Armour (STA), Wire Braid Armour (e.g. SWB), Aluminium Strip Armour (ASA), Armoured & Jacketed***
Armour Clamping	Detachable Compound Tube / Cone & AnyWay Universal Clamping Ring
Sealing Technique	Unique CMP 'LRS' Outer Seal (Load Retention Seal)
Sealing Area(s)	Inner Compound Barrier & Outer Sheath

* Mechanical & Electrical Classifications applied as per IEC 62444 & EN 62444
 ** When CMP installation accessories are used. Refer to page 7 or www.cmp-products.com for further information.
 *** Where the cable is permitted by code (NEC and/or CEC)
 **** IP68 tested to a minimum depth of 30 metres for 12 hours, alternate depths / durations can be provided upon request

Cable Gland Selection Table

Refer to illustration at the top of the page.

Cable Gland Size	Available Entry Threads "C" (Alternate Metric Thread Lengths Available)					Number of Cores	Diameter Over Conductors "A"	Cable Bedding Diameter "G"	Overall Cable Diameter "B"	Armour Range † Grooved Cone (X)		Across Flats "D"	Across Corners "D"	Protrusion Length "F"	Combined Ordering Reference ("Brass Metric")			Shroud	Cable Gland Weight (Kgs)	
	Standard			Option						Min	Max				Size	Type	Ordering Suffix			
	Metric	Thread Length (Metric) "E"	NPT	Thread Length (NPT) "E"	NPT															Max
20S16	M20	15.0	1/2"	19.9	3/4"	11	11.7	11.7	6.1	13.1	0.3	1.0	30.5	33.6	62.0	20S16	PX2KX	1RA	PVC06	0.24
20S	M20	15.0	1/2"	19.9	3/4"	11	11.7	11.7	9.5	15.9	0.3	1.0	30.5	33.6	62.0	20S	PX2KX	1RA	PVC06	0.23
20	M20	15.0	1/2"	19.9	3/4"	11	12.6	12.9	12.5	20.9	0.4	1.0	30.5	33.6	63.0	20	PX2KX	1RA	PVC06	0.24
25S	M25	15.0	3/4"	20.2	1"	21	17.5	17.9	14.0	22.0	0.4	1.2	37.5	41.3	69.5	25S	PX2KX	1RA	PVC09	0.37
25	M25	15.0	3/4"	20.2	1"	21	17.5	17.9	18.2	26.2	0.4	1.2	37.5	41.3	69.5	25	PX2KX	1RA	PVC09	0.37
32	M32	15.0	1"	25.0	1 1/4"	38	23.6	23.9	23.7	33.9	0.4	1.2	46.0	50.6	75.0	32	PX2KX	1RA	PVC11	0.57
40	M40	15.0	1 1/4"	25.6	1 1/2"	59	30.0	30.3	27.9	40.4	0.4	1.6	55.0	60.5	75.0	40	PX2KX	1RA	PVC15	0.80
50S	M50	15.0	1 1/2"	26.1	2"	89	36.6	36.9	35.2	46.7	0.4	1.6	60.0	66.0	77.0	50S	PX2KX	1RA	PVC18	0.90
50	M50	15.0	2"	26.9	2 1/2"	89	41.0	41.3	40.4	53.0	0.6	1.6	70.0	77.0	77.0	50	PX2KX	1RA	PVC21	1.19
63S	M63	15.0	2"	26.9	2 1/2"	115	47.9	48.4	45.6	59.4	0.6	1.6	75.0	82.5	79.7	63S	PX2KX	1RA	PVC23	1.39
63	M63	15.0	2 1/2"	39.9	3"	115	53.7	54.0	54.6	65.8	0.6	1.6	80.0	88.0	80.3	63	PX2KX	1RA	PVC25	1.41
75S	M75	15.0	2 1/2"	39.9	3"	140	59.9	60.2	59.0	72.0	0.6	1.6	90.0	99.0	86.8	75S	PX2KX	1RA	PVC28	2.09
75	M75	15.0	3"	41.5	3 1/2"	140	64.2	64.2	66.7	78.4	0.6	1.6	100.0	110.0	88.3	75	PX2KX	1RA	PVC30	2.54
90	M90	24.0	3 1/2"	42.8	4"	200	75.3	75.6	76.2	90.3	0.8	1.6	115.0	126.5	102.9	90	PX2KX	1RA	PVC32	3.71
100	M100	24.0	3 1/2"	42.8	4"	200	85.6	85.9	86.1	101.4	0.8	1.6	127.0	139.7	114.0	100	PX2KX	1RA	LSF33	4.31

*For material options add the following suffix to the Ordering Reference; Brass (no suffix required); Nickel Plated Brass 'S'; 316 Grade Stainless Steel '4'; Copper Free Aluminium '1'
 For NPT options please add the following digits to the material suffix; 1/2" = 31, 3/4" = 32, 1" = 33, 1 1/4" = 34, 1 1/2" = 35, 2" = 36, 2 1/2" = 37, 3" = 38, 3 1/2" = 39, 4" = 310 (Brass requires prefix "0")

Examples: 32PX2KX1RA534 = Nickel Plated Brass 1 1/4" NPT, 50SPX2KX1RA035 = Brass 1 1/2" NPT, 25PX2KX1RA432 = Stainless Steel 3/4" NPT, 20PX2KX1RA5 = Nickel Plated Brass M20

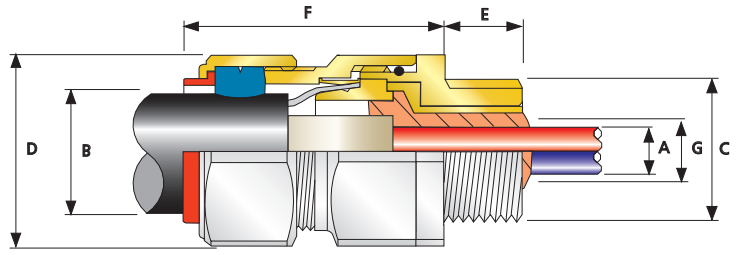

PX2KW Ex e Ex d Ex nR Ex ta

PX2KW Globally Approved, Explosive Atmosphere Barrier Cable Gland

For all types of Steel & Aluminium Wire Armoured Cables

- Metal-to-metal armour clamping
- Direct & remote installation
- Compound barrier type flameproof seal
- Controlled outer 'load retention' seal
- Unique OSTG prevents overtightening
- Integral protected deluge seal
- -60°C to +85°C
- Globally marked, IECEx, ATEX, UL & cCSAus
- Superior EMC performance



TECHNICAL DATA	
Design Specification	BS 6121:Part 1:1989, IEC 62444, EN 62444
Mechanical Classifications*	Impact = Level 8, Cable Anchorage = Class D
Enclosure Protection	IK10 to IEC 62262 (20 joules) Brass & Stainless Steel only
Electrical Classifications*	Category B
ATEX Certificate	SIRA13ATEX1072X, SIRA13ATEX4078X
Code of Protection	⊕ II 2G, II 1D, Ex d IIC Gb, Ex e IIC Gb, Ex ta IIIC Da ⊕ II 3G Ex nR IIC Gc, ⊕ IM2 Ex d I Mb, Ex e I Mb
Compliance Standards	EN 60079-0,1,7,15,31
IECEx Certificate	IECEx SIR 13.0027X, IECEx SIM 14.0008X
Code of Protection	Ex d IIC Gb, Ex e IIC Gb, Ex nR IIC Gc, Ex ta IIIC Da, Ex d I Mb, Ex e I Mb
Compliance Standards	IEC 60079-0,1,7,15,31
cCSAus Certificate (20S16 - 100)	2288626
CSAus Code of Protection***	Class I, Div. 2 Groups A, B, C and D; Class II, Div. 2 Groups F and G; Class III, Div. 2; Type 4X: Oil Resistant II: Class I, Zone 1 AEx d IIC Gb, AEx e IIC Gb, Class I, Zone 2 AEx nR IIC Gc, Class I, Zone 20 AEx ta IIIC Da
cCSA Code of Protection***	Class I, Div. 2 Groups A, B, C and D; Class II, Div. 2 Groups F and G; Class III, Div. 2; Type 4X: Oil Resistant II: Ex d IIC Gb, Ex e IIC Gb, Ex nR IIC Gc, Ex ta IIIC Da
Compliance Standards	CAN/CSA-C22.2 No 0,18,25,30,94,174, CAN/CSA-E60079-0,1,7,15,31 CAN/CSA-E6124111 Part 11, ANSI/UL 514B Ed 5, ANSI/UL 50 Ed 11, ANSI/UL 2225 Ed 4, UL60079
UL Certificate (20S16 - 100)	E161256C
Code of Protection	Class I, Div 2, Groups A,B,C,D; Class II, Div 2, Groups F,G
Compliance Standards	UL 2225, CSA C22.2 No 174, UL 514B, CSA C22.2 No 18
EAC Certificate	TC RU C-GB.ГБ05.В00138
UkrSEPRO	UA.TR.047.C.0644-15
KCS Certificate	14-GA4B0-0252X
CCOE / PESO (India) Certificate	P333688
NEPSI Certificate	GYJ13.1140X / GYJ13.1282X
INMETRO Approval	TÜV 12.2073X
RETIE Approval Number	03866
Marine Approvals	LRs: 01/00172 (E3) DNV: E-13848 ABS: 14-LD234401A-4-PDA, BV: 43180/A1
Ingress Protection Rating**	IP66, IP67 & IP68****
Deluge Protection Compliance	DTS01 : 91
Cable Gland Material	Electroless Nickel Plated Brass, Brass, Stainless Steel, Aluminium
Seal Material	CMP SOLO LSF Halogen Free Thermoset Elastomer / Epoxy Barrier Compound
Cable Type	Single Wire Armour (SWA), Aluminium Wire Armour (AWA)***
Armour Clamping	Detachable Compound Tube / Cone & AnyWay Universal Clamping Ring
Sealing Technique	Unique CMP 'LRS' Outer Seal (Load Retention Seal)
Sealing Area(s)	Inner Compound Barrier & Cable Outer Sheath

* Mechanical & Electrical Classifications applied as per IEC 62444 & EN 62444
 ** When CMP installation accessories are used. Refer to page 7 or www.cmp-products.com for further information.
 *** Where the cable is permitted by code (NEC and/or CEC)
 **** IP68 tested to a minimum depth of 30 metres for 12 hours, alternate depths / durations can be provided upon request

Cable Gland Selection Table

Refer to illustration at the top of the page.

Dimensions for alternative threads may vary, please see supplementary technical data sheet
 Dimensions listed below are for metric cable glands only

Cable Gland Size	Available Entry Threads "C" (Alternate Metric Thread Lengths Available)				Number of Cores	Diameter Over Conductors "A"	Cable Bedding Diameter "G"	Overall Cable Diameter "B"			Armour Range		Across Flats "D"	Across Corners "D"	Protrusion Length "F"	Combined Ordering Reference (*Brass Metric)			Shroud	Cable Gland Weight (Kgs)	
	Standard		Option					Min	Max	Min	Max	Min				Max	Size	Type			Ordering Suffix
	Metric	Thread Length (Metric) "E"	NPT	Thread Length (NPT) "E"																	
20S16	M20	15.0	1/2"	19.9	3/4"	11	11.7	11.7	6.1	13.1	0.8	1.25	30.5	33.6	62.0	20S16	PX2KW	1RA	PVC06	0.24	
20S	M20	15.0	1/2"	19.9	3/4"	11	11.7	11.7	9.5	15.9	0.8	1.25	30.5	33.6	62.0	20S	PX2KW	1RA	PVC06	0.23	
20	M20	15.0	1/2"	19.9	3/4"	11	12.6	12.9	12.5	20.9	0.8	1.25	30.5	33.6	63.0	20	PX2KW	1RA	PVC06	0.24	
25S	M25	15.0	3/4"	20.2	1"	21	17.5	17.9	14.0	22.0	1.25	1.6	37.5	41.3	69.5	25S	PX2KW	1RA	PVC09	0.37	
25	M25	15.0	3/4"	20.2	1"	21	17.5	17.9	18.2	26.2	1.25	1.6	37.5	41.3	69.5	25	PX2KW	1RA	PVC09	0.37	
32	M32	15.0	1"	25.0	1 1/4"	38	23.6	23.9	23.7	33.9	1.6	2.0	46.0	50.6	75.0	32	PX2KW	1RA	PVC11	0.57	
40	M40	15.0	1 1/4"	25.6	1 1/2"	59	30.0	30.3	27.9	40.4	1.6	2.0	55.0	60.5	75.0	40	PX2KW	1RA	PVC15	0.80	
50S	M50	15.0	1 1/2"	26.1	2"	89	36.6	36.9	35.2	46.7	2.0	2.5	60.0	66.0	77.0	50S	PX2KW	1RA	PVC18	0.90	
50	M50	15.0	2"	26.9	2 1/2"	89	41.0	41.3	40.4	53.0	2.0	2.5	70.1	77.1	77.1	50	PX2KW	1RA	PVC21	1.19	
63S	M63	15.0	2"	26.9	2 1/2"	115	47.9	48.4	45.6	59.4	2.0	2.5	75.0	82.5	79.7	63S	PX2KW	1RA	PVC23	1.39	
63	M63	15.0	2 1/2"	39.9	3"	115	53.7	54.0	54.6	65.8	2.0	2.5	80.0	88.0	80.3	63	PX2KW	1RA	PVC25	1.41	
75S	M75	15.0	2 1/2"	39.9	3"	140	59.9	60.2	59.0	72.0	2.0	2.5	90.0	99.0	86.8	75S	PX2KW	1RA	PVC28	2.09	
75	M75	15.0	3"	41.5	3 1/2"	140	64.2	64.2	66.7	78.4	2.5	3.0	100.0	110.0	88.3	75	PX2KW	1RA	PVC30	2.54	
90	M90	24.0	3 1/2"	42.8	4"	200	75.3	75.6	76.2	90.3	3.15	4.0	115.0	126.5	102.1	90	PX2KW	1RA	PVC32	3.71	
100	M100	24.0	3 1/2"	42.8	4"	200	85.6	85.9	86.1	101.4	3.15	4.0	127.0	139.7	114.0	100	PX2KW	1RA	LSF33	4.81	

* For material options add the following suffix to the Ordering Reference; Brass (no suffix required); Nickel Plated Brass 'S'; 316 Grade Stainless Steel '4'; Copper Free Aluminium '1'
 For NPT options add the following digits to the material suffix; 1/2" = 31; 3/4" = 32; 1" = 33; 1 1/4" = 34; 1 1/2" = 35; 2" = 36; 2 1/2" = 37; 3" = 38; 3 1/2" = 39; 4" = 310 (Brass requires prefix '0')

Examples: 32PX2KW1RA534 = Nickel Plated Brass 1 1/4" NPT, 50SPX2KW1RA035 = Brass 1 1/2" NPT, 25PX2KW1RA432 = Stainless Steel 3/4" NPT, 20PX2KW1RA5 = Nickel Plated Brass M20

Dimensions are displayed in millimetres unless otherwise stated

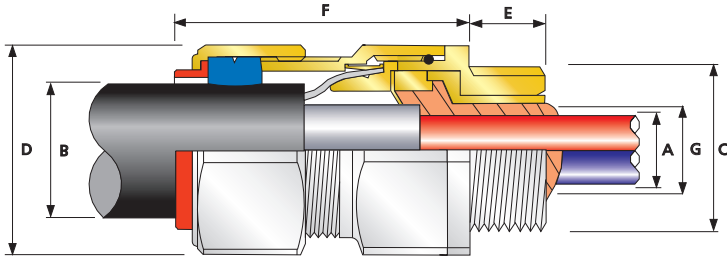

PX2KPB Ex e Exd ExnR Exta

PX2KPB Internationally Approved, Explosive Atmosphere Barrier Cable Gland

For all types of Lead Sheathed Armoured cables

- Effectively earths / grounds lead sheathed cables
- Metal-to-metal armour clamping
- Direct & remote installation
- Compound barrier type flameproof seal
- Controlled outer 'load retention' seal
- Unique OSTG prevents overtightening
- Integral protected deluge seal
- 60°C to +85°C
- Internationally marked, IECEx & ATEX
- Superior EMC performance



† Grooved Cone (X) is predominantly used for Wire Braid (e.g. GSWB, TCWB), Steel Tape Armour (STA, DSTA) and Aluminium Strip Armour (ASA) but is also suitable for Single Wire Armour (SWA), Aluminium Wire Armour (AWA) and Pliable Wire Armour (PWA) if the range is outside that of the Stepped Cone (W).

Grooved Cone (X) dimensions shown in the Cable Gland Selection Table below are for a double wire strand of braid armour cables. Tapes can also be doubled over. For cables that have only a single layer of armour such as SWA the clamping range should be used as shown in the table below.

Stepped (W) Cone is suitable for Single Wire Armour (SWA), or Aluminium Wire Armour (AWA) cables.

TECHNICAL DATA	
Design Specification	BS 6121:Part 1:1989, IEC 62444, EN 62444
Mechanical Classifications*	Impact = Level 8, Cable Anchorage = Class D
Enclosure Protection	IK10 to IEC 62262 (20 joules) Brass & Stainless Steel only
Electrical Classifications*	Category B (Category A when used with braid, tape or pliable wire armour cables)
ATEX Certificate	SIRA13ATEX1072X, SIRA13ATEX4078X
Code of Protection	⊕ II 2G, II 1D, Ex d IIC Gb, Ex e IIC Gb, Ex ta IIC Da, ⊕ II 3G Ex nR IIC Gc, ⊕ IM2 Ex d I Mb, Ex e I Mb
Compliance Standards	EN 60079-0, 1, 7, 15, 31
IECEx Certificate	IECEx SIR 13.0027X, IECEx SIM 14.0008X
Code of Protection	Ex d IIC Gb, Ex e IIC Gb, Ex nR IIC Gc, Ex ta IIC Da, Ex d I Mb, Ex e I Mb
Compliance Standards	IEC 60079-0, 1, 7, 15, 31
UkrSEPRO	UA.TR.047.C.0644-15
CCOE / PESO (India) Certificate	P333688
NEPSI Certificate	GYJ13.1140X / GYJ13.1282X
INMETRO Approval	TÜV 12.2073X
RETIE Approval Number	03866
Marine Approvals	LRS: 01/00172 (E3), DNV: E-13848, ABS: 14-LD234401A-4-PDA, BV: 43180/A1
Ingress Protection Rating**	IP66, IP67 & IP68***
Deluge Protection Compliance	DTS01 : 91
Cable Gland Material	Brass, Electroless Nickel Plated Brass, Stainless Steel, Aluminium
Seal Material	CMP SOLO LSF Halogen Free Thermoset Elastomer / Epoxy Barrier Compound
Cable Type	Lead Sheathed & Single Wire Armour (LC/SWA), Lead Sheathed & Aluminium Wire Armour (LC/AWA), Lead Sheathed & Wire Braid Armour (LC/SWB), Lead Sheathed & Pliable Wire Armour (LC/PWA), Lead Sheathed & Steel Tape Armour (LC/STA), Lead Sheathed & Aluminium Strip Armour (LC/ASA)
Armour Clamping	Detachable Compound Tube / Cone & AnyWay Universal Clamping Ring
Sealing Technique	Unique CMP 'LRS' Outer Seal (Load Retention Seal)
Sealing Area(s)	Inner Compound Barrier & Outer Sheath

* Mechanical & Electrical Classifications applied as per IEC 62444 & EN 62444

** When CMP installation accessories are used. Refer to page 7 or www.cmp-products.com for further information.

*** IP68 tested to a minimum depth of 30 metres for 12 hours, alternate depths / durations can be provided upon request

Cable Gland Selection Table

Refer to illustration at the top of the page.

Dimensions listed below are for metric cable glands only
Dimensions for alternative threads may vary, please see supplementary technical data sheet

Cable Gland Size	Available Entry Threads "C" (Alternate Metric Thread Lengths Available)				Number of Cores	Diameter Over Conductors "A"	Lead Sheath Diameter "G"		Overall Cable Diameter "B"		Armour Range †				Across Flats "D"	Across Corners "D"	Protrusion Length "F"	Combined Ordering Reference (*Brass Metric)			Shroud	Cable Gland Weight (Kgs)	
	Standard		Option				Min	Max	Min	Max	Grooved Cone (X)		Stepped Cone (W)					Size	Type	Ordering Suffix			
	Metric	Thread Length (Metric) "E"	NPT	Thread Length (NPT) "E"							Max	Max	Min	Max	Min	Max	Min				Max		
20S16	M20	15.0	1/2"	19.9	3/4"	11	7.8	3.1	7.8	6.1	13.1	0.3	1.0	0.8	1.25	30.5	33.6	62.0	20S16	PX2KPB	1RA	PVC06	0.25
20S	M20	15.0	1/2"	19.9	3/4"	11	11.0	6.1	11.0	9.5	15.9	0.3	1.0	0.8	1.25	30.5	33.6	62.0	20S	PX2KPB	1RA	PVC06	0.23
20	M20	15.0	1/2"	19.9	3/4"	11	12.6	6.5	13.4	12.5	20.9	0.4	1.0	0.8	1.25	30.5	33.6	63.0	20	PX2KPB	1RA	PVC06	0.24
25S	M25	15.0	3/4"	20.2	1"	21	17.5	11.1	19.3	14.0	22.0	0.4	1.2	1.25	1.6	37.5	41.3	69.5	25S	PX2KPB	1RA	PVC09	0.37
25	M25	15.0	3/4"	20.2	1"	21	17.5	11.1	19.3	18.2	26.2	0.4	1.2	1.25	1.6	37.5	41.3	69.5	25	PX2KPB	1RA	PVC09	0.37
32	M32	15.0	1"	25.0	1 1/4"	38	23.6	17.0	25.5	23.7	33.9	0.4	1.2	1.6	2.0	46.0	50.6	75.0	32	PX2KPB	1RA	PVC11	0.57
40	M40	15.0	1 1/4"	25.6	1 1/2"	59	30.0	22.0	31.2	27.9	40.4	0.4	1.6	1.6	2.0	55.0	60.5	75.0	40	PX2KPB	1RA	PVC15	0.80
50S	M50	15.0	1 1/2"	26.1	2"	89	36.6	29.5	37.2	35.2	46.7	0.4	1.6	2.0	2.5	60.0	66.0	77.0	50S	PX2KPB	1RA	PVC18	0.90
50	M50	15.0	2"	26.9	2 1/2"	89	41.0	35.6	42.6	40.4	53.0	0.6	1.6	2.0	2.5	70.1	77.1	77.0	50	PX2KPB	1RA	PVC21	1.19
63S	M63	15.0	2"	26.9	2 1/2"	115	47.9	40.1	48.5	45.6	59.4	0.6	1.6	2.0	2.5	75.0	82.5	79.7	63S	PX2KPB	1RA	PVC23	1.41
63	M63	15.0	2 1/2"	39.9	3"	115	53.7	47.2	54.2	54.6	65.8	0.6	1.6	2.0	2.5	80.0	88.0	80.3	63	PX2KPB	1RA	PVC25	1.44
75S	M75	15.0	2 1/2"	39.9	3"	140	59.9	52.8	60.2	59.0	72.0	0.6	1.6	2.0	2.5	90.0	99.0	86.8	75S	PX2KPB	1RA	PVC28	2.13
75	M75	15.0	3"	41.5	3 1/2"	140	64.2	59.1	65.2	66.7	78.4	0.6	1.6	2.5	3.0	100.0	110.0	88.3	75	PX2KPB	1RA	PVC30	2.57
90	M90	24.0	3 1/2"	42.8	4"	200	75.3	66.6	77.1	76.2	90.3	0.8	1.6	3.15	4.0	115.0	126.5	102.1	90	PX2KPB	1RA	PVC32	3.75
100	M100	24.0	4"	44.0	5"	200	85.6	76.0	88.1	86.1	101.4	0.8	1.6	3.15	4.0	127.0	139.7	114.0	100	PX2KPB	1RA	LSF33	4.87

*For material options add the following suffix to the Ordering Reference, Brass (no suffix required), Nickel Plated Brass '5', 316 Grade Stainless Steel '4', Copper Free Aluminium '1' For NPT options add the following digits to the material suffix, 1/2" = 31; 3/4" = 32; 1" = 33; 1 1/4" = 34; 1 1/2" = 35; 2" = 36; 2 1/2" = 37; 3" = 38; 3 1/2" = 39; 4" = 310 (Brass requires prefix '0')

Examples: 32PX2KPB1RA534 = Nickel Plated Brass 1 1/4" NPT, 50SPX2KPB1RA035 = Brass 1 1/2" NPT, 25PX2KPB1RA432 = Stainless Steel 3/4" NPT, 20PX2KPB1RA5 = Nickel Plated Brass M20

Dimensions are displayed in millimetres unless otherwise stated

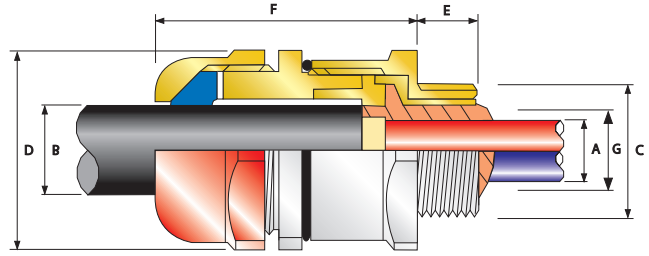

PXSS2K



PXSS2K Double Seal, Globally Approved, Explosive Atmosphere Barrier Cable Gland

For all types of Unarmoured & Braided Cables

- Direct & remote installation
- Superior levels of cable retention
- Displacement type environmental seal
- Compound barrier type flameproof seal
- Deluge protected
- -60°C to +85°C
- Globally marked, IECEx, ATEX, UL & cCSAus



TECHNICAL DATA	
Design Specification	BS 6121:Part 1:1989, IEC 62444, EN 62444
Mechanical Classifications*	Impact = Level 8, Cable Anchorage = Class B
Enclosure Protection	IK10 to IEC 62262 (20 joules) Brass & Stainless Steel only
ATEX Certificate	SIRA13ATEX1072X, SIRA13ATEX4078X
Code of Protection	Ⓜ II 2 GD, II 1D, Ex d IIC Gb, Ex e IIC Gb, Ex ta IIC Da Ⓜ II 3 G Ex nR IIC Gc, Ⓜ IM2 Ex d I Mb, Ex e I Mb
Compliance Standards	EN 60079-0,1,7,15,31
IECEx Certificate	IECEx SIR 13.0027X, IECEx SIM 14.0008X
Code of Protection	Ex d IIC Gb, Ex e IIC Gb, Ex nR IIC Gc, Ex ta IIC Da, Ex d I Mb, Ex e I Mb
Compliance Standards	IEC 60079-0,1,7,15,31
cCSAus Certificate (20516 - 100)	2288626
CSAus Code of Protection***	Class I, Div. 1, 2 Groups A, B, C and D; Class II, Div. 1, 2 Groups E, F and G; Class III, Div. 1, 2; Type 4X: Oil Resistant II: Class I, Zone 1 AEx d IIC Gb, AEx e IIC Gb, Class I, Zone 2 AEx nR IIC Gc, Class I, Zone 20 AEx ta IIC Da
cCSA Code of Protection***	Class I, Div. 1, 2 Groups A, B, C and D; Class II, Div. 1, 2 Groups E, F and G; Class III, Div. 1, 2; Type 4X: Oil Resistant II: Ex d IIC Gb, Ex e IIC Gb, Ex nR IIC Gc, Ex ta IIC Da
Compliance Standards	CAN/CSA-C22.2 No 0,18,25,30,174,94, CAN/CSA-E60079-0,1,7,15,31, CAN/CSA-E6124111 Part 11, ANSI/UL 514B Ed 5, ANSI/UL 50 Ed 11, ANSI/UL 2225 Ed 4, UL60079
UL Certificate (20516 - 100)	E201187B, E253914
Code of Protection	Class I, Groups A,B,C,D, Class II, Groups F,G Class I, Zone 1, AEx d IIC, AEx e II
Compliance Standards	UL 2225, CSA C22.2 No 174 UL 2225, UL 514B, UL 60079-0, UL 60079-7
EAC Certificate	TC RU C-GB.ГБ05.В00138
UkrSEPRO	UA.TR.047.C.0644-15
KCS Certificate	14-GA4BO-0252X
CCOE / PESO (India) Certificate	P333688
NEPSI Certificate	GYJ13.1140X / GYJ13.1282X
INMETRO Approval	TÜV 12.2073X
RETIE Approval Number	03866
Marine Approvals	LRS: 01/00172 (E3) DNV: E-13848 ABS: 14-LD234401A-4-PDA, BV: 43180/A1
Ingress Protection Rating**	IP66, IP67 & IP68****
Deluge Protection Compliance	DTS01 : 91
Cable Gland Material	Brass, Electroless Nickel Plated Brass, Stainless Steel, Aluminium
Seal Material	CMP SOLO LSF Halogen Free Thermoset Elastomer / Epoxy Barrier Compound
Cable Type	Unarmoured***
Sealing Technique	CMP Unique Displacement Seal Concept
Sealing Area(s)	Inner Compound Barrier & Outer Sheath

* Mechanical & Electrical Classifications applied as per IEC 62444 & EN 62444
 ** When CMP installation accessories are used. Refer to page 7 or www.cmp-products.com for further information.
 *** Where the cable is permitted by code (NEC and/or CEC)
 **** IP68 tested to a minimum depth of 30 metres for 12 hours, alternate depths / durations can be provided upon request

Cable Gland Selection Table

Refer to illustration at the top of the page.

Dimensions listed below are for metric cable glands only
 Dimensions for alternative threads may vary, please see supplementary technical data sheet

Cable Gland Size	Available Entry Threads "C" (Alternate Metric Thread Lengths Available)					Number of Cores	Diameter Over Conductors "A"		Cable Bedding Diameter "G"		Overall Cable Diameter "B"		Across Flats "D"	Across Corners "D"	Protrusion Length "F"	Combined Ordering Reference ("Brass Metric")			Shroud	Cable Gland Weight (Kgs)	
	Standard			Option			Max	Max	Max	Min	Max	Max				Max	Size	Type			Ordering Suffix
	Metric	Min Thread Length (Metric) "E"	NPT	Thread Length (NPT)	NPT																
20S16	M20	15.0	1/2"	19.9	3/4"	11	8.6	8.6	3.1	8.6	30.0	33.0	53.1	20S16	PXSS2K	1RA	PVC06	0.20			
20S	M20	15.0	1/2"	19.9	3/4"	11	11.7	11.7	6.1	11.7	30.0	33.0	53.1	20S	PXSS2K	1RA	PVC06	0.20			
20	M20	15.0	1/2"	19.9	3/4"	11	12.6	12.9	6.5	14.0	30.0	33.0	54.2	20	PXSS2K	1RA	PVC06	0.20			
20L	M20	15.0	1/2"	19.9	3/4"	11	12.6	12.9	10.0	15.9	30.0	33.0	54.2	20L	PXSS2K	1RA	PVC06	0.200			
25	M25	15.0	3/4"	20.2	1"	21	17.5	17.9	11.1	20.0	36.0	39.6	60.0	25	PXSS2K	1RA	PVC09	0.33			
32	M32	15.0	1"	25.0	1 1/4"	38	23.6	23.9	17.0	26.3	41.0	45.1	61.1	32	PXSS2K	1RA	PVC10	0.39			
32L	M32	15.0	1"	25.0	1 1/4"	38	23.6	23.9	20.0	27.4	41.0	45.1	61.1	32L	PXSS2K	1RA	PVC10	0.59			
40	M40	15.0	1 1/4"	25.6	1 1/2"	59	30.0	30.3	22.0	32.1	50.0	55.0	62.4	40	PXSS2K	1RA	PVC13	0.56			
50S	M50	15.0	1 1/2"	26.1	2"	89	36.6	36.9	29.5	38.2	55.0	60.5	65.2	50S	PXSS2K	1RA	PVC15	0.66			
50	M50	15.0	2"	26.9	2 1/2"	89	41.0	41.3	35.6	44.0	60.0	66.0	67.6	50	PXSS2K	1RA	PVC18	0.73			
63S	M63	15.0	2"	26.9	2 1/2"	115	47.9	48.4	40.1	49.9	70.1	77.1	71.1	63S	PXSS2K	1RA	PVC21	1.07			
63	M63	15.0	2 1/2"	39.9	3"	115	53.7	54.0	47.2	55.9	75.0	82.5	70.4	63	PXSS2K	1RA	PVC23	1.06			
75S	M75	15.0	2 1/2"	39.9	3"	140	59.9	60.2	52.8	61.9	80.0	88.0	75.3	75S	PXSS2K	1RA	PVC25	1.30			
75	M75	15.0	3"	41.5	3 1/2"	140	64.3	64.2	59.1	67.9	85.0	93.5	74.9	75	PXSS2K	1RA	PVC27	1.30			
90	M90	24.0	3 1/2"	42.8	4"	200	75.3	75.6	66.6	79.4	108.0	118.8	94.8	90	PXSS2K	1RA	PVC31	3.02			
100	M100	24.0	3 1/2"	42.8	4"	200	85.6	85.9	76.0	90.9	123.0	135.3	86.3	100	PXSS2K	1RA	LSF33	4.00			

*For material options add the following suffix to the Ordering Reference; Brass (no suffix required), Nickel Plated Brass '5', 316 Grade Stainless Steel '4', Copper Free Aluminium '1'
 For NPT options please add the following digits to the material suffix; 1/2" = 31, 3/4" = 32, 1" = 33, 1 1/4" = 34, 1 1/2" = 35, 2" = 36, 2 1/2" = 37, 3" = 38, 3 1/2" = 39, 4" = 310 (Brass requires prefix "0")

Examples: 32PXSS2K1RA534 = Nickel Plated Brass 1 1/4" NPT, 50SPXSS2K1RA035 = Brass 1 1/2" NPT, 25PXSS2K1RA432 = Stainless Steel 3/4" NPT, 20PXSS2K1RA5 = Nickel Plated Brass M20

Dimensions are displayed in millimetres unless otherwise stated

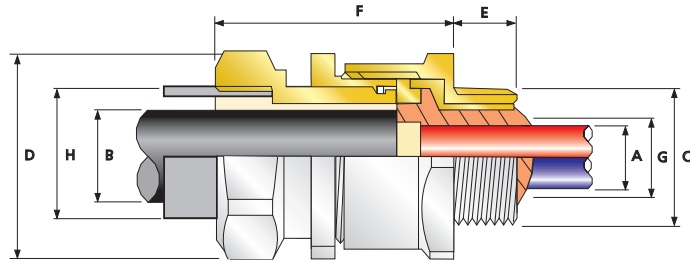

PXRC



PXRC Internationally Approved, Rigid & Flexible Conduit Explosive Atmosphere Barrier Cable Gland

For all types of Unarmoured Cables

- Designed for rigid & flexible conduits
- Easy install running coupler design
- Compound barrier type flameproof seal
- -60°C to +85°C
- Internationally marked, IECEx & ATEX



Alternative conduit sizes available upon request.

See cable gland selection table below for full NPT & Metric thread ordering references

THREAD OPTION ORDERING EXAMPLES

Ordering Reference	Male Thread	Female Thread
20PXRC1RA	M20	M20
20PXRC1RA031	M20	1/2" NPT
20PXRC1RA03131	1/2" NPT	1/2" NPT
20PXRC1RA03102	1/2" NPT	M20

Refer to "How to order" page for complete list of ordering codes.
 * For Metric female threads please insert '0' before thread size code
 e.g. 32PXRC1RA53405 (1 1/4" NPT Male x M40 Female)

Cable Gland Selection Table

Refer to illustration at the top of the page.

Cable Gland Size	Available Entry Threads "C" (Alternate Metric Thread Lengths Available)					Number of Cores	Female Connection Thread "H"	Female Connection Thread (NPT) "H"	Diameter Over Conductors "A"	Cable Bedding Diameter "G"	Overall Cable Diameter "B"	Across Flats "D"	Across Corners "D"	Protrusion Length "F"	Combined Ordering Reference (*Brass Metric)			Cable Gland Weight (Kgs)
	Standard		Option		Max										Size	Type	Ordering Suffix	
	Metric	Thread Length (Metric) "E"	NPT	Thread Length (NPT) "E"														
20	M20	15.0	1/2"	19.9	3/4"	11	M20	1/2"	12.6	12.9	13.9	30.0	33.0	45.9	20	PXRC	1RA	0.17
25	M25	15.0	3/4"	20.2	1"	21	M25	3/4"	17.5	17.9	19.9	41.0	45.1	53.6	25	PXRC	1RA	0.33
32	M32	15.0	1"	25.0	1 1/4"	38	M32	1"	23.6	23.9	26.2	41.0	45.1	51.8	32	PXRC	1RA	0.32
40	M40	15.0	1 1/4"	25.6	1 1/2"	59	M40	1 1/4"	30.0	30.3	32.3	50.0	55.0	48.6	40	PXRC	1RA	0.41
50S	M50	15.0	1 1/2"	26.1	2"	89	M50	1 1/2"	36.6	36.9	38.9	55.0	60.5	59.1	50S	PXRC	1RA	0.57
50	M50	15.0	2"	26.9	2 1/2"	89	M50	2"	41.0	41.3	44.2	60.0	66.0	64.0	50	PXRC	1RA	0.61
63S	M63	15.0	2"	26.9	2 1/2"	115	M63	2"	47.9	48.4	50.0	70.1	77.1	62.6	63S	PXRC	1RA	0.94
63	M63	15.0	2 1/2"	39.9	3"	115	M63	2 1/2"	53.7	54.0	58.0	75.0	82.5	64.6	63	PXRC	1RA	0.89
75S	M75	15.0	2 1/2"	39.9	3"	140	M75	2 1/2"	59.9	60.2	62.4	84.0	92.4	71.7	75S	PXRC	1RA	1.29
75	M75	15.0	3"	41.5	3 1/2"	140	M75	3"	64.3	64.2	68.1	85.0	93.5	71.2	75	PXRC	1RA	1.16
90	M90	24.0	3 1/2"	42.8	4"	200	M90	3 1/2"	75.3	75.6	80.1	108.0	118.8	87.3	90	PXRC	1RA	2.63

*For material options add the following suffix to the Ordering Reference: Brass (no suffix required); Nickel Plated Brass 'S'; 316 Grade Stainless Steel '4'; Copper Free Aluminium '1'
 For NPT male and / or female options please add the following digits to the material suffix (See Thread Options table above): 1/2" = 31, 3/4" = 32, 1" = 33, 1 1/4" = 34, 1 1/2" = 35, 2" = 36, 2 1/2" = 37, 3" = 38, 3 1/2" = 39, 4" = 310 (Brass requires prefix "0")
 When NPT male & Metric female product option is required, please add the following digits to the material and NPT male suffix (See Thread Options table above): M20=01, M25=02, M32=03, M40=04, M50=05, M63=06, M75=07, M90=08 (Brass requires prefix "0")
 Examples: 32PXRC1RA533 = Nickel Plated Brass M32 male x 1" NPT female, 20S16PXRC1RA031 = Brass M20 male x 1/2" NPT female, 25PXRC1RA43202 = Stainless Steel 3/4" NPT male x M25 female, 20PXRC1RA5 = Nickel Plated Brass M20 male & female

Dimensions are displayed in millimetres unless otherwise stated

TECHNICAL DATA

Design Specification	BS 6121:Part 1:1989, IEC 62444, EN 62444
Mechanical Classifications*	Impact = Level 8, Cable Anchorage = Class B
Enclosure Protection	IK10 to IEC 62262 (20 joules) Brass & Stainless Steel only
ATEX Certificate	SIRA13ATEX1072X
Code of Protection	Ⓔ II 2G, II 1D, Ex d IIC Gb, Ex e IIC Gb, Ex ta IIIC Da
Compliance Standards	EN 60079-0,1,7,31
IECEx Certificate	IECEx SIR 13.0027X, IECEx SIM 14.0008X
Code of Protection	Ex d IIC Gb, Ex e IIC Gb, Ex ta IIIC Da
Compliance Standards	IEC 60079-0,1,7,31
EAC Certificate	TC RU C-GB.Г505.B.01271
UkrSEPRO	UA.TR.047.C.0644-15
KCS Certificate	14-GA4B0-0252X
CCOE / PESO (India) Certificate	P333688
NEPSI Certificate	GYJ13.1140X / GYJ13.1282X
INMETRO Approval	TÜV 12.2073X
RETIE Approval Number	03866
Marine Approvals	LRS: 01/00172 (E3) DNV: E-13848 ABS: 14-LD234401A-4-PDA
Ingress Protection Rating**	IP66
Cable Gland Material	Brass, Electroless Nickel Plated Brass, Aluminium, Stainless Steel
Seal Material	Epoxy Barrier Compound
Cable Type	Unarmoured
Sealing Area(s)	Inner Compound Barrier

* Mechanical & Electrical Classifications applied as per IEC 62444 & EN 62444

** When CMP installation accessories are used. Refer to page 7 or www.cmp-products.com for further information.





ThermEx & ThermIn High Temperature Cable Glands

CMP Products' range of extreme high temperature cable glands available for Industrial and Explosive Atmospheres

ThermIn -
Industrial Cable Glands rated up to 200°C

ThermEx -
Explosive Atmosphere Cable Glands rated up to 200°C

Given the level of experience gained in this field CMP is able to provide a high degree of technical support advice on the selection and use of Cable Glands in Industrial and Explosive Atmosphere applications.

Alternative cable gland types are available for high temperature applications, please contact CMP

All Cable Glands shown in Nickel Plated Brass, alternative materials are available.



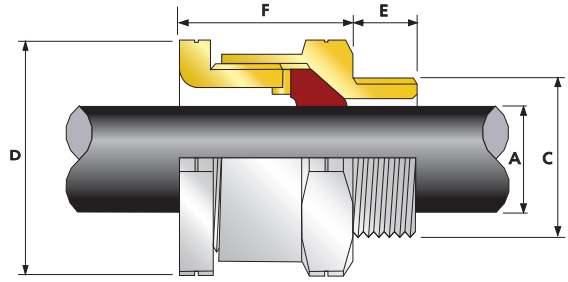

A2HT

A2HT High Temperature, Single Seal Industrial Cable Gland

For all types of Unarmoured & Braided Cables

- -60°C to 180°C high temperature ThermIn seals
- High quality durable materials
- Robust, heavy duty design
- Displacement type seal
- Deluge protected



TECHNICAL DATA	
Design Specification	BS 6121:Part 1:1989, IEC 62444, EN 62444
Mechanical Classifications*	Impact = Level 8, Cable Anchorage = Class B
Enclosure Protection	IK10 to IEC 62262 (20 joules) Brass & Stainless Steel only
Continuous Operating Temperature	-60°C to +180°C
Ingress Protection Rating**	IP66, IP67 & IP68***
Deluge Protection Compliance	DTS01 : 91
Cable Gland Material	Brass, Electroless Nickel Plated Brass, Stainless Steel, Aluminium
Seal Material	CMP Thermoset Rubber
Cable Type	Unarmoured & Braided
Sealing Technique	CMP Unique Displacement Seal Concept
Sealing Area(s)	Cable Outer Sheath

* Mechanical & Electrical Classifications applied as per IEC 62444 & EN 62444
 ** When CMP installation accessories are used. Refer to page 7 or www.cmp-products.com for further information.
 *** IP68 tested to a minimum depth of 30 metres for 12 hours, alternate depths / durations can be provided upon request

Cable Gland Selection Table

Refer to illustration at the top of the page.

Dimensions listed below are for metric cable glands only
 Dimensions for alternative threads may vary, please see supplementary technical data sheet

Cable Gland Size	Available Entry Threads "C" (Alternate Metric Thread Lengths Available)					Overall Cable Diameter		Across Flats "D"	Across Corners "D"	Protrusion Length "F"	Combined Ordering Reference (*Brass Metric)		
	Standard				Option	Min	Max	Max	Max	Max	Size	Type	Ordering Suffix
	Metric	Thread Length (Metric) "E"	NPT	Thread Length (NPT) "E"	NPT								
16	M16	10.0	-	-	-	3.2	8.0	24.0	26.4	34.9	16	A2HT	1RA
16P	M16	10.0	-	-	-	3.2	8.0	22.0	24.2	34.7	16P	A2HT	1RA
20S/16	M20	10.0	1/2"	19.9	3/4"	3.2	8.0	24.0	26.4	32.9	20S16	A2HT	1RA
20S/16P	M20	10.0	-	-	-	3.2	8.0	22.0	24.2	32.4	20S16P	A2HT	1RA
20S	M20	10.0	1/2"	19.9	3/4"	6.5	11.2	24.0	26.4	34.9	20S	A2HT	1RA
20SP	M20	10.0	-	-	-	6.5	11.2	22.0	24.2	34.4	20SP	A2HT	1RA
20	M20	10.0	1/2"	19.9	3/4"	7.0	13.5	27.0	29.7	36.8	20	A2HT	1RA
20P	M20	10.0	-	-	-	7.0	13.5	24.0	26.4	41.1	20P	A2HT	1RA
25	M25	10.0	3/4"	20.2	1"	11.5	19.5	36.0	39.6	43.1	25	A2HT	1RA
25P	M25	10.0	-	-	-	11.5	19.5	32.0	35.2	49.4	25P	A2HT	1RA
32	M32	10.0	1"	25.0	1 1/4"	19.0	25.5	41.0	45.1	41.5	32	A2HT	1RA
40	M40	15.0	1 1/4"	25.6	1 1/2"	25.0	32.2	50.0	55.0	39.1	40	A2HT	1RA
50S	M50	15.0	1 1/2"	26.1	2"	31.0	38.2	55.0	60.5	41.4	50S	A2HT	1RA
50	M50	15.0	2"	26.9	2 1/2"	35.6	44.0	60.0	66.0	45.8	50	A2HT	1RA
63S	M63	15.0	2"	26.9	2 1/2"	41.5	49.9	70.5	77.6	43.3	63S	A2HT	1RA
63	M63	15.0	2 1/2"	39.9	3"	48.2	54.9	75.0	82.5	43.6	63	A2HT	1RA
75S	M75	15.0	2 1/2"	39.9	3"	54.0	61.9	84.0	92.4	45.4	75S	A2HT	1RA

*For material options add the following suffix to the Ordering Reference; Brass (no suffix required); Nickel Plated Brass '5'; 316 Grade Stainless Steel '4'; Copper Free Aluminium '1'
 For NPT options add the following digits to the material suffix; 1/2" = 31; 3/4" = 32; 1" = 33; 1 1/4" = 34; 1 1/2" = 35; 2" = 36; 2 1/2" = 37; 3" = 38; 3 1/2" = 39; 4" = 310 (Brass requires prefix '0')

Examples: 32A21RA534 = Nickel Plated Brass 1 1/4" NPT, 50SA21RA035 = Brass 1 1/2" NPT, 25A21RA432 = Stainless Steel 3/4" NPT, 20A21RA5 = Nickel Plated Brass M20

Dimensions are displayed in millimetres unless otherwise stated

Please contact CMP for Cable Gland weights and Shroud sizing

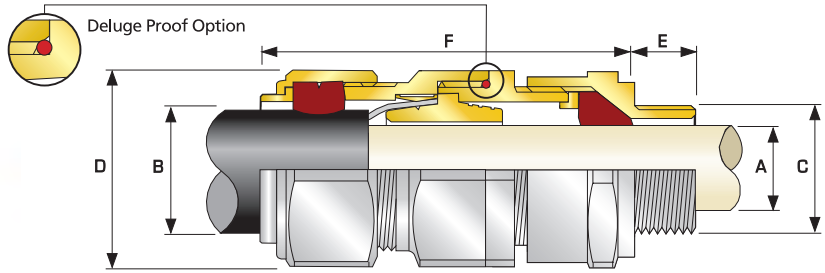

E1UHT

E1UHT High Temperature, Double Seal Industrial Cable Gland

For all types of Armoured cables

- -20°C to 200°C high temperature ThermIn seals
- Metal-to-metal armour clamping
- Direct & remote installation
- Permanently crimped, low impedance earth termination
- Secure against self-loosening
- Displacement type inner seal
- Controlled outer 'load retention' seal
- Unique OSTG prevents overtightening
- Deluge protection option
- Superior EMC performance



† Grooved Cone (X) is predominantly used for Wire Braid (e.g. GSWB, TCWB), Steel Tape Armour (STA, DSTA) and Aluminium Strip Armour (ASA) but is also suitable for Single Wire Armour (SWA), Aluminium Wire Armour (AWA) and Pliable Wire Armour (PWA) if the range is outside that of the Stepped Cone (W).

Grooved Cone (X) dimensions shown in the Cable Gland Selection Table below are for a double wire strand of braid armour cables. Tapes can also be doubled over. For cables that have only a single layer of armour such as SWA the clamping range should be used as shown in the table below.

Stepped (W) Cone is suitable for Single Wire Armour (SWA), or Aluminium Wire Armour (AWA) cables.

TECHNICAL DATA

Design Specification	BS 6121:Part 1:1989, IEC 62444, EN 62444
Mechanical Classifications*	Impact = Level 8, Cable Anchorage = Class D
Enclosure Protection	IK10 to IEC 62262 (20 joules) Brass & Stainless Steel only
Electrical Classifications*	Category B (Category A when used with braid, tape or pliable wire armour cables)
Continuous Operating Temperature	-20°C to +200°C
Ingress Protection Rating**	IP66 as standard (IP67, IP68*** available upon request)
Cable Gland Material	Brass, Electroless Nickel Plated Brass, Aluminium
Seal Material	CMP Thermoset Rubber
Cable Type	Single Wire Armour (SWA), Aluminium Wire Armour (AWA), Pliable Wire Armour (PWA), Steel Tape Armour (STA), Wire Braid Armour, Aluminium Strip Armour (ASA), Screened Flexible (EMC) Wire Braid (e.g. CY / SY), Armoured & Jacketed
Armour Clamping	Reversible Armour Cone & AnyWay Universal Clamping Ring
Sealing Technique	CMP Inner Displacement Seal & Unique CMP 'LRS'™ Outer Load Retention Seal
Sealing Area(s)	Cable Inner Bedding & Outer Cable Sheath

* Mechanical & Electrical Classifications applied as per IEC 62444 & EN 62444

** When CMP installation accessories are used. Refer to page 7 or www.cmp-products.com for further information.

*** IP68 tested to a minimum depth of 30 metres for 12 hours, alternate depths / durations can be provided upon request

Cable Gland Selection Table

Refer to illustration at the top of the page.

Dimensions listed below are for metric cable glands only
Dimensions for alternative threads may vary, please see supplementary technical data sheet

Cable Gland Size	Available Entry Threads "C" (Alternate Metric Thread Lengths Available)					Cable Bedding Diameter "A"		Overall Cable Diameter "B"		Armour Range †				Across Flats "D"	Across Corners "D"	Protusion Length "F"	Combined Ordering Reference (*Brass Metric)			Shroud	Cable Gland Weight (Kgs)
	Standard			Option		Min	Max	Min	Max	Groove Cone (X)		Stepped Cone (W)		Max	Max		Size	Type	Ordering Suffix		
	Metric	Thread Length (Metric) "E"	NPT	Thread Length (NPT) "E"	NPT					Min	Max	Min	Max								
20S16	M20	10.0	1/2"	19.9	3/4"	3.1	8.6	6.1	13.1	0.3	1.0	0.8	1.25	24.0	26.4	72.5	20S16	E1UHT	1RA	PVC04	0.163
20S	M20	10.0	1/2"	19.9	3/4"	6.1	11.6	9.5	15.9	0.3	1.0	0.8	1.25	24.0	26.4	70.0	20S	E1UHT	1RA	PVC04	0.150
20	M20	10.0	1/2"	19.9	3/4"	6.5	13.9	12.5	20.9	0.4	1.0	0.8	1.25	30.5	33.6	73.0	20	E1UHT	1RA	PVC06	0.200
25S	M25	10.0	3/4"	20.2	1"	11.1	19.9	14.0	22.0	0.4	1.2	1.25	1.6	37.5	41.3	89.0	25S	E1UHT	1RA	PVC09	0.330
25	M25	10.0	3/4"	20.2	1"	11.1	19.9	18.2	26.2	0.4	1.2	1.25	1.6	37.5	41.3	89.0	25	E1UHT	1RA	PVC09	0.330
32	M32	10.0	1"	25.0	1 1/4"	17.0	26.2	23.7	33.9	0.4	1.2	1.6	2.0	46.0	50.6	86.0	32	E1UHT	1RA	PVC11	0.430
40	M40	15.0	1 1/4"	25.6	1 1/2"	22.0	32.1	27.9	40.4	0.4	1.6	1.6	2.0	55.0	60.5	90.0	40	E1UHT	1RA	PVC15	0.620
50S	M50	15.0	1 1/2"	26.1	2"	29.5	38.1	35.2	46.7	0.4	1.6	2.0	2.5	60.0	66.0	91.0	50S	E1UHT	1RA	PVC18	0.750
50	M50	15.0	2"	26.9	2 1/2"	35.6	44.0	40.4	53.0	0.6	1.6	2.0	2.5	70.1	77.1	95.0	50	E1UHT	1RA	PVC21	0.950
63S	M63	15.0	2"	26.9	2 1/2"	40.1	49.9	45.6	59.4	0.6	1.6	2.0	2.5	75.0	82.5	102.0	63S	E1UHT	1RA	PVC23	1.340
63	M63	15.0	2 1/2"	39.9	3"	47.2	55.9	54.6	65.8	0.6	1.6	2.0	2.5	80.0	88.0	104.0	63	E1UHT	1RA	PVC25	1.340
75S	M75	15.0	2 1/2"	39.9	3"	52.8	61.9	59.0	72.0	0.6	1.6	2.0	2.5	90.0	99.0	115.0	75S	E1UHT	1RA	PVC28	2.110
75	M75	15.0	3"	41.5	3 1/2"	59.1	67.9	66.7	78.4	0.6	1.6	2.5	3.0	100.0	110.0	117.0	75	E1UHT	1RA	PVC30	2.420
90	M90	24.0	3 1/2"	42.8	4"	66.6	78.6	76.2	90.3	0.8	1.6	3.15	4.0	114.3	125.4	147.0	90	E1UHT	1RA	PVC32	4.210
100	M100	24.0	3 1/2"	42.8	4"	76.0	90.9	86.1	101.4	0.8	1.6	3.15	4.0	123.0	135.3	140.0	100	E1UHT	1RA	LSF33	4.450
115	M115	24.0	4"	44.0	5"	86.0	97.9	101.5	110.2	0.8	1.6	3.15	4.0	133.4	146.7	162.0	115	E1UHT	1RA	LSF34	6.190
130	M130	24.0	5"	46.8	-	97.0	114.9	110.2	123.2	0.8	1.6	3.15	4.0	152.4	160.6	174.0	130	E1UHT	1RA	LSF35	8.340

*Note: For material options please add the following suffix to change the Ordering Reference: Brass (no suffix required), Nickel Plated Brass "S", Copper Free Aluminium "1"
For NPT options add the following digits to the material suffix, 1/2" = 31; 3/4" = 32; 1" = 33; 1 1/4" = 34; 1 1/2" = 35; 2" = 36; 2 1/2" = 37; 3" = 38; 3 1/2" = 39; 4" = 310 (Brass requires prefix '0')

Examples: 32E1UHT1RA534 = Nickel Plated Brass 1 1/4" NPT, 50SE1UHT1RA035 = Brass 1 1/2" NPT, 25E1UHT1RA432 = 20E1UHT1RA5 = Nickel Plated Brass M20

Dimensions are displayed in millimetres unless otherwise stated

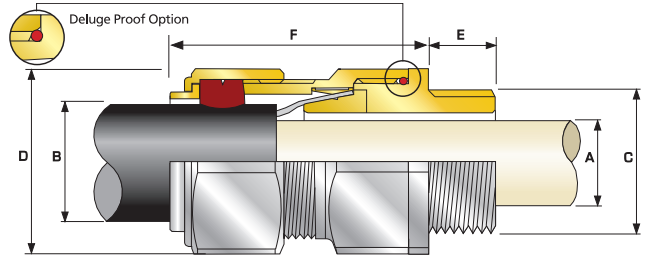

CWHT

CWHT High Temperature, Single Seal Industrial Cable Gland

For all types Steel & Aluminium Wire Armoured cables

- -20°C to 200°C high temperature ThermIn seals
- High quality durable materials
- Robust, heavy duty design
- Metal-to-metal armour clamping
- Direct & remote installation
- Permanently crimped, low impedance earth termination
- Secure against self-loosening
- Controlled outer 'load retention' seal
- Unique OSTG prevents overtightening
- Deluge protection option
- Superior EMC performance



Deluge Proof option available (CWDHT)

TECHNICAL DATA

Design Specification	BS 6121:Part 1:1989, IEC 62444, EN 62444
Mechanical Classifications*	Impact = Level 8, Cable Anchorage = Class D
Enclosure Protection	IK10 to IEC 62262 (20 joules) Brass & Stainless Steel only
Electrical Classifications*	Category B
Continuous Operating Temperature	-20°C to +200°C
Ingress Protection Rating**	IP66
Cable Gland Material	Brass, Electroless Nickel Plated Brass, Stainless Steel, Aluminium
Seal Material	CMP Thermoset Rubber
Cable Type	Single Wire Armour (SWA), Aluminium Wire Armour (AWA)
Armour Clamping	Detachable Armour Cone & AnyWay Universal Clamping Ring
Sealing Technique	Unique CMP 'LRS' Outer Seal (Load Retention Seal)
Sealing Area(s)	Cable Outer Sheath
Cable Gland Kits Available	Cable Gland kit for use with all types of SWA cable including 2 Brass Cable Glands, 2 Steel Locknuts, 2 Brass Earth Tags and 2 PVC Shrouds for sizes up to and including 32mm. For sizes 40mm and above each kit includes 1 of each component.

* Mechanical & Electrical Classifications applied as per IEC 62444 & EN 62444

** When CMP installation accessories are used. Refer to page 7 or www.cmp-products.com for further information.

Cable Gland Selection Table

Refer to illustration at the top of the page.

Cable Gland Size	Entry Thread "C"	Thread Length (Metric) "E"	Cable Bedding Diameter "A"	Overall Cable Diameter "B"		Armour Range		Across Flats "D"	Across Corners "D"	Protrusion Length "F"	Combined Ordering Reference (*Brass Metric)			Shroud	Cable Gland Weight (Kgs)
				Min	Max	Min	Max				Max	Max	Size		
20S16	M20	10.0	8.7	6.1	13.1	0.8	1.25	24.0	26.4	48.0	20S16	CWHT	1RA	PVC04	0.100
20S	M20	10.0	11.7	9.5	15.9	0.8	1.25	24.0	26.4	48.0	20S	CWHT	1RA	PVC04	0.100
20	M20	10.0	14.0	12.5	20.9	0.8	1.25	30.5	33.6	48.0	20	CWHT	1RA	PVC06	0.147
25S	M25	10.0	20.0	14.0	22.0	1.25	1.6	37.5	41.3	56.0	25S	CWHT	1RA	PVC09	0.224
25	M25	10.0	20.0	18.2	26.2	1.25	1.6	37.5	41.3	56.0	25	CWHT	1RA	PVC09	0.221
32	M32	10.0	26.3	23.7	33.9	1.6	2.0	46.0	50.6	54.0	32	CWHT	1RA	PVC11	0.306
40	M40	15.0	32.2	27.9	40.4	1.6	2.0	55.0	60.5	58.0	40	CWHT	1RA	PVC15	0.448
50S	M50	15.0	38.2	35.2	46.7	2.0	2.5	60.0	66.0	61.0	50S	CWHT	1RA	PVC18	0.567
50	M50	15.0	44.1	40.4	53.0	2.0	2.5	70.1	77.1	60.0	50	CWHT	1RA	PVC21	0.751
63S	M63	15.0	50.0	45.6	59.4	2.0	2.5	75.0	82.5	74.0	63S	CWHT	1RA	PVC23	1.036
63	M63	15.0	56.0	54.6	65.8	2.0	2.5	80.0	88.0	71.0	63	CWHT	1RA	PVC25	1.016
75S	M75	15.0	62.0	59.0	72.0	2.0	2.5	90.0	99.0	86.0	75S	CWHT	1RA	PVC28	1.787
75	M75	15.0	68.0	66.7	78.4	2.5	3.0	100.0	110.0	82.0	75	CWHT	1RA	PVC30	2.091
90	M90	24.0	80.0	76.2	90.3	3.15	4.0	114.3	125.7	95.0	90	CWHT	1RA	PVC32	3.044
100	M100	24.0	91.0	86.1	101.4	3.15	4.0	123.0	135.3	95.0	100	CWHT	1RA	LSF33	3.132
115	M115	24.0	98.0	101.5	110.2	3.15	4.0	133.4	146.7	107.5	115	CWHT	1RA	LSF34	4.476
130	M130	24.0	115.0	110.2	123.2	3.15	4.0	152.4	167.6	110.0	130	CWHT	1RA	LSF35	5.761

*For material options add the following suffix to the Ordering Reference; Brass (no suffix required); Nickel Plated Brass 'S'; 316 Grade Stainless Steel '4'; Copper Free Aluminium '1'

Examples: 20CWHT1RA5 = Nickel Plated Brass M20, 50CWHT1RA = Brass 50mm, 25CWHT1RA4 = Stainless Steel 25mm

Dimensions are displayed in millimetres unless otherwise stated

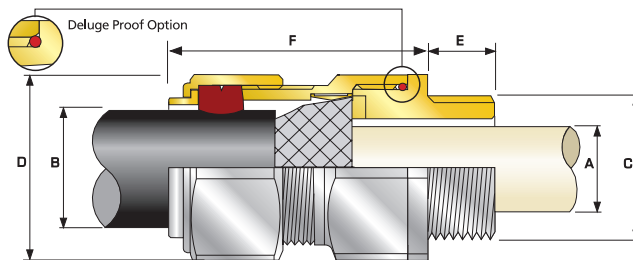

CMP EXTREME HIGH TEMPERATURE PRODUCTS

CXHT

CXHT High Temperature, Single Seal Industrial Cable Gland

For Braided & Steel Tape Armoured Cables

- -20°C to 200°C high temperature ThermIn seals
- High quality durable materials
- Robust, heavy duty design
- Metal-to-metal armour clamping
- Direct & remote installation
- Permanently crimped, low impedance earth termination
- Secure against self-loosening
- Controlled outer 'load retention' seal
- Unique OSTG prevents overtightening
- Deluge protection option
- Superior EMC performance



Deluge Proof option available (CXDHT)

† Grooved Cone (X) is predominantly used for Wire Braid (e.g. GSWB, TCWB), Steel Tape Armour (STA, DSTA) and Aluminium Strip Armour (ASA) but is also suitable for Single Wire Armour (SWA), Aluminium Wire Armour (AWA) and Pliable Wire Armour (PWA) if the range is outside that of the Stepped Cone (W).

Grooved Cone (X) dimensions shown in the Cable Gland Selection Table below are for a double wire strand of braid armour cables. Tapes can also be doubled over. For cables that have only a single layer of armour such as SWA the clamping range should be used as shown in the table below.

TECHNICAL DATA	
Design Specification	BS 6121:Part 1:1989, IEC 62444, EN 62444
Mechanical Classifications*	Impact = Level 8, Cable Anchorage = Class D
Enclosure Protection	IK10 to IEC 62262 (20 joules) Brass & Stainless Steel only
Electrical Classifications*	Category B (Category A when used with braid, tape or pliable wire armour cables)
Continuous Operating Temperature	-20°C to +200°C
Ingress Protection Rating**	IP66
Cable Gland Material	Brass, Electroless Nickel Plated Brass, Stainless Steel, Aluminium
Seal Material	CMP Thermoset Rubber
Cable Type	Wire Braid Armour, Screened Flexible (EMC) Wire Braid (e.g. CY / SY), Pliable Wire Armour (PWA), Steel Tape Armour (STA)
Armour Clamping	Detachable Armour Cone & AnyWay Universal Clamping Ring
Sealing Technique	Unique CMP 'LRS' Outer Seal (Load Retention Seal)
Sealing Area(s)	Cable Outer Sheath
Cable Gland Kits Available	Cable Gland kit for use with all types of SWA cable including 2 Brass Cable Glands, 2 Steel Locknuts, 2 Brass Earth Tags and 2 PVC Shrouds for sizes up to and including 32mm. For sizes 40mm and above each kit includes 1 of each component.

* Mechanical & Electrical Classifications applied as per IEC 62444 & EN 62444

** When CMP installation accessories are used. Refer to page 7 or www.cmp-products.com for further information.

Cable Gland Selection Table

Refer to illustration at the top of the page.

Cable Gland Size	Entry Thread "C"	Thread Length (Metric) "E"	Cable Bedding Diameter "A"	Overall Cable Diameter "B"		Armour Range † Grooved Cone (X)		Across Flats "D"	Across Corners "D"	Protrusion Length "F"	Combined Ordering Reference (*Brass Metric)			Shroud	Cable Gland Weight (Kgs)
				Max	Min	Min	Max				Max	Max	Size		
20S16	M20	10.0	8.7	6.1	13.1	0.3	1.0	24.0	26.4	48.0	20S16	CXHT	1RA	PVC04	0.100
20S	M20	10.0	11.7	9.5	15.9	0.3	1.0	24.0	26.4	48.0	20S	CXHT	1RA	PVC04	0.100
20	M20	10.0	14.0	12.5	20.9	0.4	1.0	30.5	33.6	48.0	20	CXHT	1RA	PVC06	0.147
25S	M25	10.0	20.0	14.0	22.0	0.4	1.2	37.5	41.3	56.0	25S	CXHT	1RA	PVC09	0.224
25	M25	10.0	20.0	18.2	26.2	0.4	1.2	37.5	41.3	56.0	25	CXHT	1RA	PVC09	0.221
32	M32	10.0	26.0	23.7	33.9	0.4	1.2	46.0	50.6	54.0	32	CXHT	1RA	PVC11	0.308
40	M40	15.0	32.2	27.9	40.4	0.4	1.6	55.0	60.5	58.0	40	CXHT	1RA	PVC15	0.448
50S	M50	15.0	38.2	35.2	46.7	0.4	1.6	60.0	66.0	61.0	50S	CXHT	1RA	PVC18	0.567
50	M50	15.0	44.1	40.4	53.0	0.6	1.6	70.1	77.1	60.0	50	CXHT	1RA	PVC21	0.751
63S	M63	15.0	50.0	45.6	59.4	0.6	1.6	75.0	82.5	74.0	63S	CXHT	1RA	PVC23	1.036
63	M63	15.0	56.0	54.6	65.8	0.6	1.6	80.0	88.0	71.0	63	CXHT	1RA	PVC25	1.016
75S	M75	15.0	62.0	59.0	72.0	0.6	1.6	90.0	99.0	86.0	75S	CXHT	1RA	PVC28	1.787
75	M75	15.0	64.2	66.7	78.4	0.6	1.6	100.0	110.0	82.0	75	CXHT	1RA	PVC30	2.091
90	M90	24.0	78.6	76.2	90.3	0.8	1.6	114.3	125.7	95.0	90	CXHT	1RA	PVC32	3.044
100	M100	24.0	91.0	86.1	101.4	0.8	1.6	123.0	135.3	95.0	100	CXHT	1RA	LSF33	3.132
115	M115	24.0	98.0	101.5	110.2	0.8	1.6	133.4	146.7	107.5	115	CXHT	1RA	LSF34	4.476
130	M130	24.0	115.0	110.2	123.2	0.8	1.6	152.4	167.6	110.0	130	CXHT	1RA	LSF35	5.761

*For material options add the following suffix to the Ordering Reference; Brass (no suffix required); Nickel Plated Brass '5'; 316 Grade Stainless Steel '4'; Copper Free Aluminium '1'

Examples: 20CXHT1RA5 = Nickel Plated Brass M20

Dimensions are displayed in millimetres unless otherwise stated

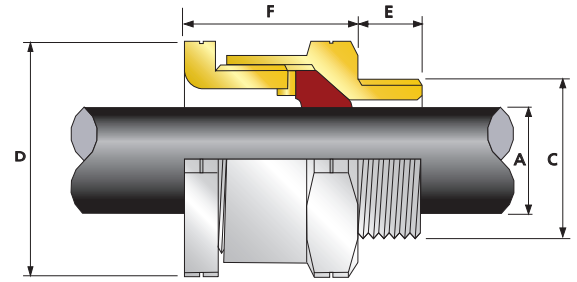

A2FHT



A2FHT Internationally Approved, Explosive Atmosphere Cable Gland

For all types of Unarmoured & Braided Cables

- -60°C to 180°C high temperature ThermEx seals
- Displacement type flameproof seal
- Deluge protected
- Internationally marked, IECEx & ATEX



TECHNICAL DATA	
Design Specification	BS 6121:Part 1:1989, IEC 62444, EN 62444
Mechanical Classifications*	Impact = Level 8, Cable Anchorage = Class B
Enclosure Protection	IK10 to IEC 62262 (20 joules) Brass & Stainless Steel only
ATEX Certificate	SIRA16ATEX1019X, SIRA16ATEX4021X
Code of Protection	Ⓜ II 2G Ex db IIC Gb, II 2G Ex eb IIC Gb, II 1D Ex ta IIIC Da IP66, IP67, IP68 Ⓜ II 3G Ex nRc IIC IP66, IP67, IP68
Compliance Standards	EN60079-0,1,7,15,31
IECEx Certificate	IECEx SIR 16.0007X
Code of Protection	Ex db IIC Gb, Ex eb IIC Gb, Ex ta IIIC Da, Ex nRc IIC Gc IP66, IP67, IP68
Compliance Standards	IEC 60079-0,1,7,15,31
Continuous Operating Temperature	-60°C to +180°C
Ingress Protection Rating**	IP66, IP67 & IP68***
Deluge Protection Compliance	DTS01 : 91
Cable Gland Material	Brass, Electroless Nickel Plated Brass, Stainless Steel, Aluminium
Seal Material	CMP SOLO LSF Halogen Free Thermoset Elastomer
Cable Type	Unarmoured & Braided when terminated inside enclosure
Sealing Technique	CMP Unique Displacement Seal Concept
Sealing Area(s)	Cable Outer Sheath

* Mechanical & Electrical Classifications applied as per IEC 62444 & EN 62444

** When CMP installation accessories are used. Refer to page 7 or www.cmp-products.com for further information.

*** IP68 tested to a minimum depth of 30 metres for 12 hours, alternate depths / durations can be provided upon request

Cable Gland Selection Table

Refer to illustration at the top of the page.

Dimensions listed below are for metric cable glands only
Dimensions for alternative threads may vary, please see supplementary technical data sheet

Cable Gland Size	Available Entry Threads "C" (Alternate Metric Thread Lengths Available)					Overall Cable Diameter		Across Flats "D"	Across Corners "D"	Protrusion Length "F"	Combined Ordering Reference (*Brass Metric)		
	Standard				Option	Min	Max	Max	Max	Max	Size	Type	Ordering Suffix
	Metric	Thread Length (Metric) "E"	NPT	Thread Length (NPT) "E"	NPT								
16	M16	15.0	-	-	-	3.2	8.0	24.0	26.4	34.9	16	A2FHT	1RA
16P	M16	15.0	-	-	-	3.2	8.0	22.0	24.2	34.7	16P	A2FHT	1RA
20S/16	M20	15.0	1/2"	19.9	3/4"	3.2	8.0	24.0	26.4	31.4	20S16	A2FHT	1RA
20S/16P	M20	15.0	-	-	-	3.2	8.0	22.0	24.2	32.1	20S16P	A2FHT	1RA
20S	M20	15.0	1/2"	19.9	3/4"	6.5	11.2	24.0	26.4	32.1	20S	A2FHT	1RA
20SP	M20	15.0	-	-	-	6.5	11.2	22.0	24.2	32.1	20SP	A2FHT	1RA
20	M20	15.0	1/2"	19.9	3/4"	7.0	13.5	27.0	29.7	35.8	20	A2FHT	1RA
20P	M20	15.0	-	-	-	7.0	13.5	24.0	26.4	41.4	20P	A2FHT	1RA
25	M25	15.0	3/4"	20.2	1"	11.5	19.5	36.0	39.6	40.4	25	A2FHT	1RA
25P	M25	15.0	-	-	-	11.5	19.5	32.0	35.2	49.7	25P	A2FHT	1RA
32	M32	15.0	1"	25.0	1 1/4"	19.0	25.5	41.0	45.1	38.5	32	A2FHT	1RA
40	M40	15.0	1 1/4"	25.6	1 1/2"	25.0	32.2	50.0	55.0	39.1	40	A2FHT	1RA
50S	M50	15.0	1 1/2"	26.1	2"	31.0	38.2	55.0	60.5	41.4	50S	A2FHT	1RA
50	M50	15.0	2"	26.9	2 1/2"	35.6	44.0	60.0	66.0	45.8	50	A2FHT	1RA
63S	M63	15.0	2"	26.9	2 1/2"	41.5	49.9	70.5	77.6	43.3	63S	A2FHT	1RA
63	M63	15.0	2 1/2"	39.9	3"	48.2	54.9	75.0	82.5	43.6	63	A2FHT	1RA
75S	M75	15.0	2 1/2"	39.9	3"	54.0	61.9	84.0	92.4	45.4	75S	A2FHT	1RA

*For material options add the following suffix to the Ordering Reference; Brass (no suffix required); Nickel Plated Brass '5'; 316 Grade Stainless Steel '4'; Copper Free Aluminium '1'
For NPT options add the following digits to the material suffix; 1/2" = 31; 3/4" = 32; 1" = 33; 1 1/4" = 34; 1 1/2" = 35; 2" = 36; 2 1/2" = 37; 3" = 38; 3 1/2" = 39; 4" = 310 (Brass requires prefix '0')

Examples: 32A2F1RA534 = Nickel Plated Brass 1 1/4" NPT, 50SA2F1RA035 = Brass 1 1/2" NPT, 25A2F1RA432 = Stainless Steel 3/4" NPT, 20A2F1RA5 = Nickel Plated Brass M20

Dimensions are displayed in millimetres unless otherwise stated

Please contact CMP for Cable Gland weights and Shroud sizing

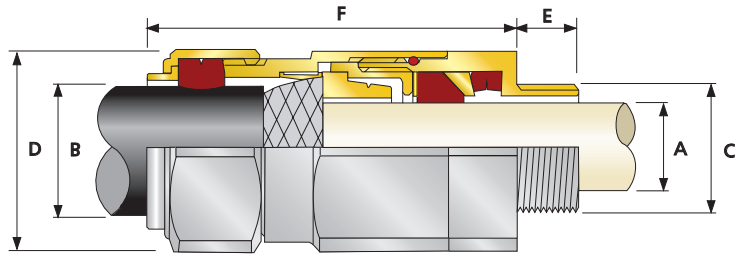
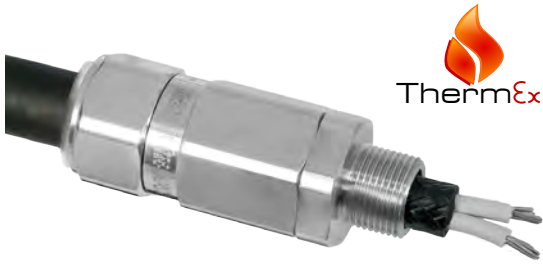

T3CDSHT



Triton CDS (T3CDSHT) Internationally Approved, Explosive Atmosphere Cable Gland

For all types of Armoured Cables

- 20°C to 200°C high temperature ThermEx seals
- Fully sequential, three step installation procedure
- Reduces installation times, cost & risk
- Direct & remote installation
- Unique compensating displacement seal system (CDS)
 - Metal-to-metal installation every time regardless of cable diameter
- Designed to reduce the effects of Coldflow
- Integral protected deluge seal
- Controlled outer 'load retention' seal
- Unique OSTG prevents overtightening
- Internationally marked, IECEx & ATEX
- Superior EMC performance



† Grooved Cone (X) is predominantly used for Wire Braid (e.g. GSWB, TCWB), Steel Tape Armour (STA, DSTA) and Aluminium Strip Armour (ASA) but is also suitable for Single Wire Armour (SWA), Aluminium Wire Armour (AWA) and Pliable Wire Armour (PWA) if the range is outside that of the Stepped Cone (W).

Grooved Cone (X) dimensions shown in the Cable Gland Selection Table below are for a double wire strand of braid armoured cables. Tapes can also be doubled over. For cables that have only a single layer of armour such as SWA the clamping range should be used as shown in the table below.

Stepped (W) Cone is suitable for Single Wire Armour (SWA), or Aluminium Wire Armour (AWA) cables.

TECHNICAL DATA	
Design Specification	BS 6121:Part 1:1989, IEC 62444, EN 62444
Mechanical Classification	Impact = Level 8, Cable Anchorage = Class D
Enclosure Protection	IK10 to IEC 62262 (20 joules) Brass & Stainless Steel only
Electrical Classification	Category B (Category A when used with braid, tape or pliable wire armour cables)
ATEX Certificate	SIRA13ATEX1073X, SIRA13ATEX4079X
Code of Protection	Ⓜ II 2G, II 1D, Ex d IIC Gb, Ex e IIC Gb, Ex ta IIIC Da, Ⓜ II 3G Ex nR IIC Gc, Ⓜ I M2, Ex d I Mb, Ex e I Mb
Compliance Standards	EN60079-0,1,7,15,31
IECEx Certificate	IECEx SIR 13.0028X, IECEx SIM 14.0007X
Code of Protection	Ex d IIC Gb, Ex e IIC Gb, Ex nR IIC Gc, Ex ta IIIC Da, Ex d I Mb, Ex e I Mb
Compliance Standards	IEC 60079-0,1,7,15,31
Continuous Operating Temperature	-20°C to +200°C
Ingress Protection Rating**	IP66, IP67 & IP68***
Deluge Protection	DTS01 : 91
Cable Gland Material	Brass, Electroless Nickel Plated Brass, Aluminium, Stainless Steel
Seal Material	CMP SOLO LSF Halogen Free Thermoset Elastomer
Cable Type(s)	Single Wire Armour (SWA), Aluminium Wire Armour (AWA), Pliable Wire Armour (PWA), Steel Tape Armour (STA), Aluminium Strip Armour (ASA), Screened Flexible (EMC) Wire Braid (e.g. CY/SY), Wire Braid Armour (e.g. SWB)
Armour Clamping	Reversible Armour Cone & AnyWay Universal Clamping Ring
Sealing Technique	Inner Bedding Sealing Ring: Compensating Displacement Seal (CDS), Outer Sheath Sealing Ring: Load Retention Seal (LRS)
Sealing Area(s)	Cable Inner Bedding & Outer Cable Sheath

* Mechanical & Electrical Classifications applied as per IEC 62444 & EN 62444
 ** When CMP installation accessories are used. Refer to page 7 or www.cmp-products.com for further information.
 *** IP68 tested to a minimum depth of 30 metres for 12 hours, alternate depths / durations can be provided upon request

Cable Gland Selection Table

Refer to illustration at the top of the page.

Dimensions listed below are for metric cable glands only
 Dimensions for alternative threads may vary, please see supplementary technical data sheet

Cable Gland Size	Available Entry Threads "C" (Alternate Metric Thread Lengths Available)					Cable Bedding Diameter "A"		Overall Cable Diameter "B"		Armour Range †				Across Flats "D"	Across Corners "D"	Protrusion Length "F"	Combined Ordering Reference (*Brass Metric)			Shroud	Cable Gland Weight (Kgs)
	Standard			Option		Min	Max	Min	Max	Grooved Cone (X)		Stepped Cone (W)					Size	Type	Ordering Suffix		
	Metric	Thread Length (Metric) "E"	NPT	Thread Length (NPT) "E"	NPT					Min	Max	Min	Max	Min	Max	Min				Max	
20S16	M20	15.0	1/2"	19.9	3/4"	3.1	8.6	6.1	13.1	0.3	1.0	0.8	1.25	24.0	26.4	78.7	20S16	T3CDSHT	1RA	PVC36	0.20
20S	M20	15.0	1/2"	19.9	3/4"	6.1	11.6	9.5	15.9	0.3	1.0	0.8	1.25	24.0	26.4	78.7	20S	T3CDSHT	1RA	PVC36	0.20
20	M20	15.0	1/2"	19.9	3/4"	6.5	13.9	12.5	20.9	0.4	1.0	0.8	1.25	30.5	33.6	76.2	20	T3CDSHT	1RA	PVC06	0.28
25S	M25	15.0	3/4"	20.2	1"	11.1	19.9	14.0	22.0	0.4	1.2	1.25	1.6	37.5	41.3	88.8	25S	T3CDSHT	1RA	PVC09	0.44
25	M25	15.0	3/4"	20.2	1"	11.1	19.9	18.2	26.2	0.4	1.2	1.25	1.6	37.5	41.3	88.7	25	T3CDSHT	1RA	PVC09	0.44
32	M32	15.0	1"	25.0	1 1/4"	17.0	26.2	23.7	33.9	0.4	1.2	1.6	2.0	46.0	50.6	90.7	32	T3CDSHT	1RA	PVC11	0.63
40	M40	15.0	1 1/4"	25.6	1 1/2"	22.0	32.1	27.9	40.4	0.4	1.6	1.6	2.0	55.0	60.5	93.2	40	T3CDSHT	1RA	PVC15	0.91
50S	M50	15.0	1 1/2"	26.1	2"	29.5	38.1	35.2	46.7	0.4	1.6	2.0	2.5	60.0	66.0	100.7	50S	T3CDSHT	1RA	PVC18	1.12
50	M50	15.0	2"	26.9	2 1/2"	35.6	44.0	40.4	53.0	0.6	1.6	2.0	2.5	70.1	77.1	105.8	50	T3CDSHT	1RA	PVC21	1.60
63S	M63	15.0	2"	26.9	2 1/2"	40.1	49.9	45.6	59.4	0.6	1.6	2.0	2.5	75.0	82.4	102.5	63S	T3CDSHT	1RA	PVC23	1.73
63	M63	15.0	2 1/2"	39.9	3"	47.2	55.9	54.6	65.8	0.6	1.6	2.0	2.5	80.0	88.0	105.4	63	T3CDSHT	1RA	PVC25	1.78
75S	M75	15.0	2 1/2"	39.9	3"	52.8	61.9	59.0	72.0	0.6	1.6	2.0	2.5	90.0	99.0	110.6	75S	T3CDSHT	1RA	PVC28	2.57
75	M75	15.0	3"	41.5	3 1/2"	59.1	67.9	66.7	78.4	0.6	1.6	2.5	3.0	100.0	110.0	120.3	75	T3CDSHT	1RA	PVC30	3.33
90	M90	24.0	3 1/2"	42.8	4"	66.6	78.6	76.2	90.3	0.8	1.6	3.15	4.0	115.0	126.5	138.9	90	T3CDSHT	1RA	PVC32	4.87
100	M100	24.0	3 1/2"	42.8	4"	76.0	90.9	86.1	101.4	0.8	1.6	3.15	4.0	127.0	139.7	128.2	100	T3CDSHT	1RA	LSF33	4.97
115	M115	24.0	4"	44.0	5"	86.0	97.9	101.5	110.2	0.8	1.6	3.15	4.0	138.0	151.8	161.3	115	T3CDSHT	1RA	LSF34	7.72
130	M130	24.0	5"	46.8	-	97.0	114.9	110.2	123.2	0.8	1.6	3.15	4.0	157.0	172.7	173.3	130	T3CDSHT	1RA	LSF35	9.78

*For material options add the following suffix to the Ordering Reference; Brass (no suffix required), Nickel Plated Brass '5'; 316 Grade Stainless Steel '4'; Copper Free Aluminium '1'
 For NPT options add the following digits to the material suffix; 1/2" = 31; 3/4" = 32; 1" = 33; 1 1/4" = 34; 1 1/2" = 35; 2" = 36; 2 1/2" = 37; 3" = 38; 3 1/2" = 39; 4" = 310 (Brass requires prefix '0')

Examples: 32T3CDSHT1RA534 = Nickel Plated Brass 1 1/4" NPT, 50S3T3CDSHT1RA035 = Brass 1 1/2" NPT, 25T3CDSHT1RA432 = Stainless Steel 3/4" NPT, 20T3CDSHT1RA5 = Nickel Plated Brass M20

Dimensions are displayed in millimetres unless otherwise stated

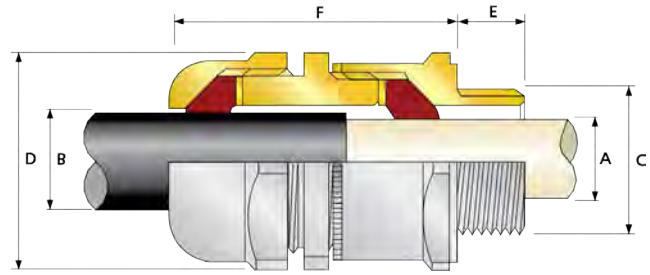

SS2KHT



SS2KHT Double Seal, Internationally Approved, Explosive Atmosphere Cable Gland

For all types of Unarmoured & Braided Cables

- -20°C to 200°C high temperature ThermEx seals
- Provides double seal on outer sheath or single on outer & inner
- Direct & remote installation
- Superior levels of cable retention
- Displacement type flameproof seals
- Deluge protected
- Internationally marked IECEx & ATEX



TECHNICAL DATA	
Design Specification	BS 6121:Part 1:1989, IEC 62444, EN 62444
Mechanical Classifications*	Impact = Level 8, Cable Anchorage = Class B
Enclosure Protection	IK10 to IEC 62262 (20 joules) Brass & Stainless Steel only
ATEX Certificate	SIRA13ATEX1069X, SIRA13ATEX4075X
Code of Protection	⊕ II 2G, II 1D, Ex d IIC Gb, Ex e IIC Gb, Ex ta IIIC Da ⊕ II 3G Ex nR IIC Gc, ⊕ IM2 Ex d I Mb, Ex e I Mb
Compliance Standards	EN 60079-0,1,7,15,31
IECEx Certificate	IECEx SIR 13.0024X
Code of Protection	Ex d IIC Gb, Ex e IIC Gb, Ex nR IIC Gc, Ex ta IIIC Da, Ex d I Mb, Ex e I Mb
Compliance Standards	IEC 60079-0,1,7,15,31
Continuous Operating Temperature	-20°C to +200°C
Ingress Protection Rating**	IP66, IP67 & IP68***
Cable Gland Material	Brass, Electroless Nickel Plated Brass, Stainless Steel, Aluminium
Seal Material	CMP SOLO LSF Halogen Free Thermoset Elastomer
Cable Type	Unarmoured & Braided
Sealing Technique	CMP Unique Displacement Seal Concept
Sealing Area(s)	Cable Inner Bedding & Outer Cable Sheath, Double Seal on Cable Outer Sheath

* Mechanical & Electrical Classifications applied as per IEC 62444 & EN 62444

** When CMP installation accessories are used. Refer to page 7 or www.cmp-products.com for further information.

*** IP68 tested to a minimum depth of 30 metres for 12 hours, alternate depths / durations can be provided upon request

Cable Gland Selection Table

Refer to illustration at the top of the page.

Dimensions listed below are for metric cable glands only
Dimensions for alternative threads may vary, please see supplementary technical data sheet

Cable Gland Size	Available Entry Threads "C" (Alternate Metric Thread Lengths Available)					Cable Bedding Diameter "A"		Overall Cable Diameter "B"		Across Flats "D"	Across Corners "D"	Protrusion Length "F"	Combined Ordering Reference (*Brass Metric)			Shroud	Cable Gland Weight (Kgs)
	Standard			Option		Min	Max	Min	Max	Max	Max		Size	Type	Ordering Suffix		
	Metric	Thread Length (Metric) "E"	NPT	Thread Length (NPT) "E"	NPT												
20S16	M20	15.0	½"	19.9	¾"	3.2	8.6	3.2	8.6	24.0	26.4	49.0	20S16	SS2KHT	1RA	PVC04	0.140
20S	M20	15.0	½"	19.9	¾"	6.1	11.7	6.1	11.7	24.0	26.4	49.0	20S	SS2KHT	1RA	PVC04	0.130
20	M20	15.0	½"	19.9	¾"	6.5	14.0	6.5	14.0	27.0	29.7	54.0	20	SS2KHT	1RA	PVC05	0.160
25	M25	15.0	¾"	20.2	1"	11.1	20.0	11.1	20.0	36.0	39.6	66.0	25	SS2KHT	1RA	PVC09	0.300
32	M32	15.0	1"	25.0	1 ¼"	17.0	26.3	17.0	26.3	41.0	45.1	67.0	32	SS2KHT	1RA	PVC10	0.350
40	M40	15.0	1 ¼"	25.6	1 ½"	23.5	32.1	23.5	32.1	50.0	55.0	70.0	40	SS2KHT	1RA	PVC13	0.500
50S	M50	15.0	1 ½"	26.1	2"	31.0	38.2	31.0	38.2	55.0	60.5	65.0	50S	SS2KHT	1RA	PVC15	0.560
50	M50	15.0	2"	26.9	2 ½"	35.6	44.0	35.6	44.0	60.0	66.0	70.0	50	SS2KHT	1RA	PVC18	0.590
63S	M63	15.0	2"	26.9	2 ½"	41.5	49.9	41.5	49.9	70.5	77.6	70.0	63S	SS2KHT	1RA	PVC21	0.890
63	M63	15.0	2 ½"	39.9	3"	47.2	55.9	47.2	55.9	75.0	82.5	71.0	63	SS2KHT	1RA	PVC23	0.850
75S	M75	15.0	2 ½"	39.9	3"	54.0	61.9	54.0	61.9	80.0	88.0	70.0	75S	SS2KHT	1RA	PVC25	1.020
75	M75	15.0	3"	41.5	3 ½"	61.1	67.9	61.1	67.9	84.0	92.4	75.0	75	SS2KHT	1RA	PVC26	0.990
90	M90	24.0	3 ½"	42.8	4"	66.6	79.4	66.6	79.4	108.0	118.8	113.0	90	SS2KHT	1RA	PVC31	2.990
100	M100	24.0	3 ½"	42.8	4"	76.0	90.9	76.0	90.9	123.0	134.2	106.0	100	SS2KHT	1RA	LSF33	3.390
115	M115	24.0	4"	44.0	5"	86.0	97.9	86.0	97.9	133.4	146.7	128.0	115	SS2KHT	1RA	LSF34	5.320
130	M130	24.0	5"	46.8	-	97.0	114.9	97.0	114.9	152.4	167.6	129.0	130	SS2KHT	1RA	LSF35	6.350

*For material options add the following suffix to the Ordering Reference: Brass (no suffix required); Nickel Plated Brass '5'; 316 Grade Stainless Steel '4'; Copper Free Aluminium '1'
For NPT options add the following digits to the material suffix; ½" = 31; ¾" = 32; 1" = 33; 1 ¼" = 34; 1 ½" = 35; 2" = 36; 2 ½" = 37; 3" = 38; 3 ½" = 39; 4" = 310 (Brass requires prefix '0')

Examples: 32SS2KHT1RA534 = Nickel Plated Brass 1 ¼" NPT, 50SSS2KHT1RA035 = Brass 1 ½" NPT, 25SS2KHT1RA432 = Stainless Steel ¾" NPT, 20SS2KHT1RA5 = Nickel Plated Brass M20

Dimensions are displayed in millimetres unless otherwise stated

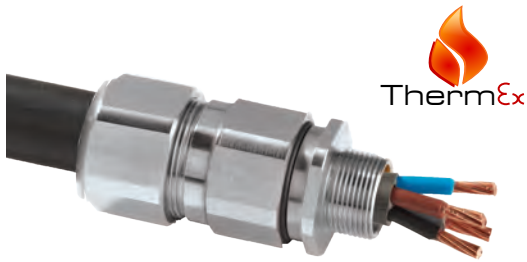

ThermEx

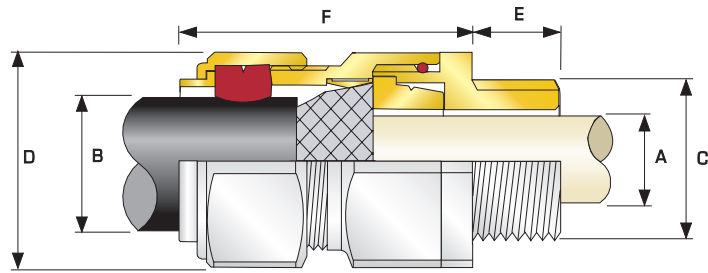

C2KHT



C2KHT Internationally Approved, Ex e, Explosive Atmosphere Cable Gland

For all types of Armoured cables

- -20°C to 200°C high temperature ThermEx seals
- Metal-to-metal armour clamping
- Direct & remote installation
- Integral protected deluge seal
- Displacement type flameproof seal
- Controlled outer 'load retention' seal
- Unique OSTG prevents overtightening
- Internationally marked, IECEx & ATEX
- Superior EMC performance



† Grooved Cone (X) is predominantly used for Wire Braid (e.g. GSWB, TCWB), Steel Tape Armour (STA, DSTA) and Aluminium Strip Armour (ASA) but is also suitable for Single Wire Armour (SWA), Aluminium Wire Armour (AWA) and Pliable Wire Armour (PWA) if the range is outside that of the Stepped Cone (W).

Grooved Cone (X) dimensions shown in the Cable Gland Selection Table below are for a double wire strand of braid armour cables. Tapes can also be doubled over. For cables that have only a single layer of armour such as SWA the clamping range should be used as shown in the table below.

Stepped (W) Cone is suitable for Single Wire Armour (SWA), or Aluminium Wire Armour (AWA) cables.

TECHNICAL DATA

Design Specification	BS 6121:Part 1:1989, IEC 62444, EN 62444
Mechanical Classifications*	Impact = Level 8, Cable Anchorage = Class D
Enclosure Protection	IK10 to IEC 62262 (20 joules) Brass & Stainless Steel only
Electrical Classifications*	Category B (Category A when used with braid, tape or pliable wire armour cables)
ATEX Certificate	SIRA13ATEX1070X
Code of Protection	⊕ II 2G, II 1D, Ex e IIC Gb, Ex ta IIIC Da
Compliance Standards	EN 60079-0,7,31
IECEx Certificate	IECEx SIR 13.0025X
Code of Protection	Ex e IIC Gb, Ex ta IIIC Da
Compliance Standards	IEC 60079-0,7,31
Continuous Operating Temperature	-20°C to +200°C
Ingress Protection Rating**	IP66, IP67 & IP68***
Deluge Protection Compliance	DTS01 : 91
Cable Gland Material	Brass, Electroless Nickel Plated Brass, Stainless Steel, Aluminium
Seal Material	CMP SOLO LSF Halogen Free Thermoset Elastomer
Cable Type	Single Wire Armour (SWA), Aluminium Wire Armour (AWA), Pliable Wire Armour (PWA), Steel Tape Armour (STA), Wire Braid Armour (e.g. SWB), Aluminium Strip Armour (ASA), Screened Flexible (EMC) Wire Braid (e.g. CY / SY), Armoured & Jacketed
Armour Clamping	Reversible Armour Cone & AnyWay Universal Clamping Ring
Sealing Technique	Unique CMP 'LRS' Outer Seal (Load Retention Seal)
Sealing Area(s)	Cable Outer Sheath

* Mechanical & Electrical Classifications applied as per IEC 62444 & EN 62444

** When CMP installation accessories are used. Refer to page 7 or www.cmp-products.com for further information.

*** IP68 tested to a minimum depth of 30 metres for 12 hours, alternate depths / durations can be provided upon request

Cable Gland Selection Table

Refer to illustration at the top of the page.

Dimensions listed below are for metric cable glands only
Dimensions for alternative threads may vary, please see supplementary technical data sheet

Cable Gland Size	Available Entry Threads "C" (Alternate Metric Thread Lengths Available)					Cable Bedding Diameter "A"	Overall Cable Diameter "B"			Armour Range †				Across Flats "D"	Across Corners "D"	Protrusion Length "F"	Combined Ordering Reference (*Brass Metric)			Shroud	Cable Gland Weight (Kgs)
	Standard		Option				Min	Max	Max	Grooved Cone (X)		Stepped Cone (W)					Size	Type	Ordering Suffix		
	Metric	Thread Length (Metric) "E"	NPT	Thread Length (NPT) "E"	NPT					Min	Max	Min	Max								
20S16	M20	15.0	½"	19.9	¾"	8.7	6.1	13.1	0.3	1.0	0.8	1.25	30.5	33.6	65.0	20S16	C2KHT	1RA	PVC04	0.23	
20S	M20	15.0	½"	19.9	¾"	11.7	9.5	15.9	0.3	1.0	0.8	1.25	30.5	33.6	62.0	20S	C2KHT	1RA	PVC04	0.24	
20	M20	15.0	½"	19.9	¾"	14.0	12.5	20.9	0.4	1.0	0.8	1.25	30.5	33.6	63.0	20	C2KHT	1RA	PVC06	0.23	
25S	M25	15.0	¾"	20.2	1"	20.0	14.0	22.0	0.4	1.2	1.25	1.6	37.5	41.3	69.5	25S	C2KHT	1RA	PVC09	0.35	
25	M25	15.0	¾"	20.2	1"	20.0	18.2	26.2	0.4	1.2	1.25	1.6	37.5	41.3	69.5	25	C2KHT	1RA	PVC09	0.35	
32	M32	15.0	1"	25.0	1 ¼"	26.0	23.7	33.9	0.4	1.2	1.6	2.0	46.0	50.6	75.0	32	C2KHT	1RA	PVC11	0.55	
40	M40	15.0	1 ¼"	25.6	1 ½"	32.2	27.9	40.4	0.4	1.6	1.6	2.0	55.0	60.5	75.0	40	C2KHT	1RA	PVC15	0.75	
50S	M50	15.0	1 ½"	26.1	2"	38.2	35.2	46.7	0.4	1.6	2.0	2.5	60.0	66.0	77.0	50S	C2KHT	1RA	PVC18	0.86	
50	M50	15.0	2"	26.9	2 ½"	44.1	40.4	53.0	0.6	1.6	2.0	2.5	70.1	77.1	77.0	50	C2KHT	1RA	PVC21	1.13	
63S	M63	15.0	2"	26.9	2 ½"	50.0	45.6	59.4	0.6	1.6	2.0	2.5	75.0	82.5	80.0	63S	C2KHT	1RA	PVC23	1.13	
63	M63	15.0	2 ½"	39.9	3"	56.0	54.6	65.8	0.6	1.6	2.0	2.5	80.0	88.0	80.0	63	C2KHT	1RA	PVC25	1.34	
75S	M75	15.0	2 ½"	39.9	3"	62.0	59.0	72.0	0.6	1.6	2.0	2.5	90.0	99.0	87.0	75S	C2KHT	1RA	PVC28	2.02	
75	M75	15.0	3"	41.5	3 ½"	64.2	66.7	78.4	0.6	1.6	2.5	3.0	100.0	110.0	88.0	75	C2KHT	1RA	PVC30	2.48	
90	M90	24.0	3 ½"	42.8	4"	78.6	76.2	90.3	0.8	1.6	3.15	4.0	115.0	126.5	102.0	90	C2KHT	1RA	PVC32	3.52	
100	M100	24.0	3 ½"	42.8	4"	91.0	86.1	101.4	0.8	1.6	3.15	4.0	127.0	139.7	114.0	100	C2KHT	1RA	LSF33	4.58	
115	M115	24.0	4"	44.0	5"	98.0	101.5	110.2	0.8	1.6	3.15	4.0	133.4	146.7	114.0	115	C2KHT	1RA	LSF34	6.50	
130	M130	24.0	5"	46.8	-	115.0	110.2	123.2	0.8	1.6	3.15	4.0	152.4	167.6	114.0	130	C2KHT	1RA	LSF35	8.50	

*For material options add the following suffix to the Ordering Reference; Brass (no suffix required); Nickel Plated Brass 'S'; 316 Grade Stainless Steel '4'; Copper Free Aluminium '1' For NPT options add the following digits to the material suffix; ½" = 31; ¾" = 32; 1" = 33; 1 ¼" = 34; 1 ½" = 35; 2" = 36; 2 ½" = 37; 3" = 38; 3 ½" = 39; 4" = 310 (Brass requires prefix '0')

Examples: 32C2KHT1RA534 = Nickel Plated Brass 1 ¼" NPT, 50S2KHT1RA035 = Brass 1 ½" NPT, 25C2KHT1RA432 = Stainless Steel ¾" NPT, 20C2KHT1RA5 = Nickel Plated Brass M20

Dimensions are displayed in millimetres unless otherwise stated





Flat-Form Cable Glands

The CMP range of Certified Explosive Atmosphere and Industrial Cable Glands specifically designed for use with flat form and heat trace cables.

These Cable Glands are certified in line with all of CMP's products to the highest and most recent standards, and include optional high temperature ThermEx seals.

Multiple certification including ATEX, IECEx, and EAC enables the possibility of selecting fewer standard products for global situations. Some solutions in the standard CMP Explosive Atmosphere range offer approvals allowing their deployment under IEC installation codes of practice.

All Cable Glands shown in Nickel Plated Brass, alternative materials are available.

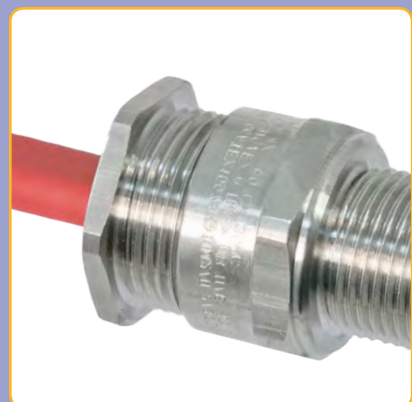
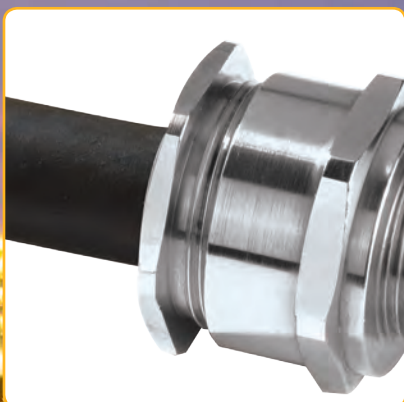

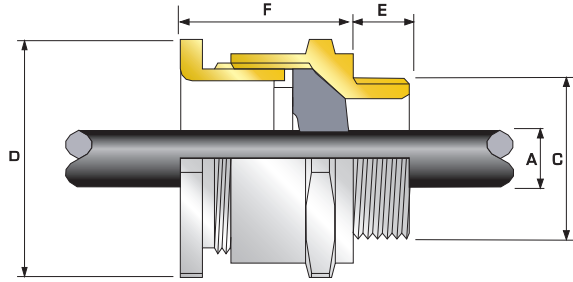

A2FF

A2FF Single Seal, Flat-Form Industrial Cable Gland

For all types of Flat-Form Unarmoured & Braided Cables

- Designed for flat form / heat trace cables
- Displacement type seal
- Deluge protected
- -60°C to +130°C (standard), -20°C to 200°C (ThermIn option)



Flat-form seals available for alternative Cable Glands upon request

TECHNICAL DATA

Design Specification	BS 6121:Part 1:1989, IEC 62444, EN 62444
Enclosure Protection	IK10 to IEC 62262 (20 joules) Brass & Stainless Steel only
Ingress Protection Rating**	IP66, IP67 & IP68***
Deluge Protection Compliance	DTS01 : 91
Cable Gland Material	Brass, Electroless Nickel Plated Brass, Stainless Steel, Aluminium
Seal Material	CMP Thermoset Rubber
Cable Type	Flat Form Unarmoured & Braided when terminated inside enclosure
Sealing Technique	CMP Unique Displacement Seal Concept
Sealing Area(s)	Cable Outer Sheath

* Mechanical & Electrical Classifications applied as per IEC 62444 & EN 62444

** When CMP installation accessories are used. Refer to page 7 or www.cmp-products.com for further information.

*** IP68 tested to a minimum depth of 30 metres for 12 hours, alternate depths / durations can be provided upon request

Cable Gland Selection Table

Refer to illustration at the top of the page.

Dimensions listed below are for metric cable glands only
Dimensions for alternative threads may vary, please see supplementary technical data sheet

Cable Gland Size	Available Entry Threads "C" (Alternate Metric Thread Lengths Available)					Overall Cable Diameter "A" (h x w)		Across Flats "D"	Across Corners "D"	Protrusion Length "F"	Combined Ordering Reference (*Brass Metric)			Cable Gland Weight (Kgs)
	Standard		Option			Min	Max				Size	Type	Ordering Suffix	
	Metric	Thread Length (Metric) "E"	NPT	Thread Length (NPT) "E"	NPT	Min	Max	Max	Max	Size	Type	Ordering Suffix		
20S	M20	10.0	½"	19.9	¾"	4.0 x 6.2	6.8 x 11.7	24.0	26.4	25.1	20S	A2FF	1RA	0.054
20	M20	10.0	½"	19.9	¾"	5.7 x 8.0	8.7 x 13.5	27.0	29.7	27.2	20	A2FF	1RA	0.059

*For material options add the following suffix to the Ordering Reference, Brass (no suffix required), Nickel Plated Brass '5'; 316 Grade Stainless Steel '4'; Copper Free Aluminium '1'
For NPT options please add the following digits to the material suffix; ½" = 31, ¾" = 32, 1" = 33

Examples: 25A2FF1RA432 = Stainless Steel ¾" NPT, 20A2FF1RA5 = Nickel Plated Brass M20

Dimensions are displayed in millimetres unless otherwise stated

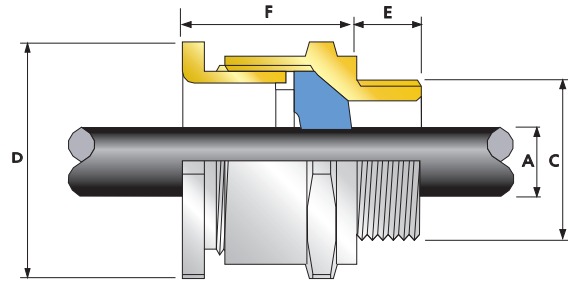

A2F-FF Ex e Exd ExnR Exta

A2F Internationally Approved, Flat-Form Explosive Atmosphere Cable Gland

For all types of Flat-Form Unarmoured & Braided Cables

- Designed for flat form / heat trace cables
- Displacement type flameproof seal
- Deluge protected
- -60°C to +130°C (standard), -20°C to 200°C (ThermEx option)
- Internationally marked, IECEx & ATEX



Flat-form seals available for alternative Cable Glands upon request

TECHNICAL DATA	
Design Specification	BS 6121:Part 1:1989, IEC 62444, EN 62444
Mechanical Classifications*	Impact = Level 8, Cable Anchorage = Class B
Enclosure Protection	IK10 to IEC 62262 (20 joules) Brass & Stainless Steel only
ATEX Certificate	SIRA13ATEX1068X, SIRA13ATEX4074X
Code of Protection	⊕ II 2G, II 1D Ex d IIC Gb, Ex e IIC Gb, Ex ta IIIC Da ⊕ II 3G Ex nR IIC Gc, I M2 Ex d I Mb, Ex e I Mb
Compliance Standards	EN 60079-0,1,7,15,31
IECEx Certificate	IECEx SIR 13.0023X, IECEx SIM 14.00006
Code of Protection	Ex d IIC Gb, Ex e IIC Gb, Ex nR IIC Gc, Ex ta IIIC Da, Ex d I Mb, Ex e I Mb
Compliance Standards	IEC 60079-0,1,7,15,31
EAC Certificate	TC RU C-GB.ГБ05.В00138
KCS Certificate	13_GA4BO_0748X; 13_GA4BO_0749X; 13_GA4BO_0750X; 14_GA4BO_0251X
CCOE / PESO Certificate (India)	P333688
Ingress Protection Rating**	IP66, IP67 & IP68***
Deluge Protection Compliance	DTS01 : 91
Cable Gland Material	Brass, Electroless Nickel Plated Brass, Stainless Steel, Aluminium
Seal Material	CMP SOLO LSF Halogen Free Thermoset Elastomer
Cable Type	Flat Form Unarmoured & Braided when terminated inside enclosure
Sealing Technique	CMP Unique Displacement Seal Concept
Sealing Area(s)	Cable Outer Sheath

* Mechanical & Electrical Classifications applied as per IEC 62444 & EN 62444
 ** When CMP installation accessories are used. Refer to page 7 or www.cmp-products.com for further information.
 *** IP68 tested to a minimum depth of 30 metres for 12 hours, alternate depths / durations can be provided upon request

Cable Gland Selection Table

Refer to illustration at the top of the page.

Dimensions listed below are for metric cable glands only
 Dimensions for alternative threads may vary, please see supplementary technical data sheet

Cable Gland Size	Available Entry Threads "C" (Alternate Metric Thread Lengths Available)					Overall Cable Diameter "A" (h x w)		Across Flats "D"	Across Corners "D"	Protrusion Length "F"	Combined Ordering Reference (*Brass Metric)			Cable Gland Weight (Kgs)
	Standard				Option	Min	Max				Size	Type	Ordering Suffix	
	Metric	Thread Length (Metric) "E"	NPT	Thread Length (NPT) "E"	NPT									
205	M20	15.0	½"	19.9	¾"	4.0 x 6.2	6.8 x 11.7	24.0	26.4	25.1	205	A2FFF	1RA	0.054
20	M20	15.0	½"	19.9	¾"	5.7 x 8.0	8.7 x 13.5	27.0	29.7	27.2	20	A2FFF	1RA	0.059

*For material options add the following suffix to the Ordering Reference; Brass (no suffix required); Nickel Plated Brass '5'; 316 Grade Stainless Steel '4'; Copper Free Aluminium '1'
 For NPT options please add the following digits to the material suffix; ½" = 31, ¾" = 32, 1" = 33

Examples: 25A2FFF1RA432 = Stainless Steel ¾" NPT, 20A2FFF1RA5 = Nickel Plated Brass M20

Dimensions are displayed in millimetres unless otherwise stated





Mining Group I Cable Glands

CMP Products' Underground Mining Group I cable gland range accommodates all forms of cable used in mining locations.

The Group I Certified range of Cable Glands provide both the installer and OEM with the choice of using either a threaded entry Cable Gland or a flange mounted version; both being suitable for direct entry into the equipment.

Where a threaded entry is provided in the equipment and a flanged mounted gland either already exists or is preferred, CMP can supply a suitable adaptor which will convert from a threaded entry to a flanged entry by use of a MA/TF adaptor.

For installations using non-filled cables, Barrier Cable Glands are available and provide a compound barrier seal around the conductors and an environmental seal on the cable outer sheath. Again these are available for all cable types and can be supplied with either a threaded or flanged entry.

All Cable Glands shown in Nickel Plated Brass, alternative materials are available.

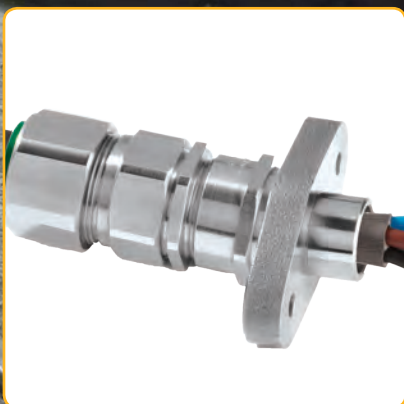

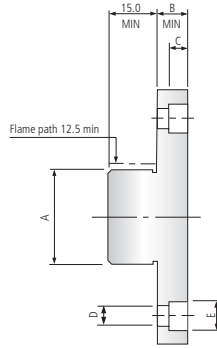
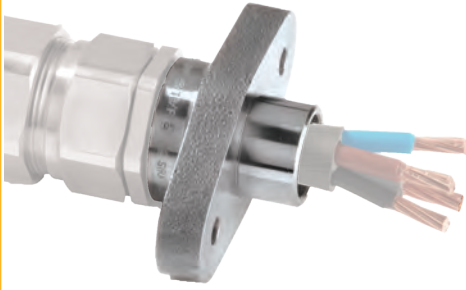

MA/B

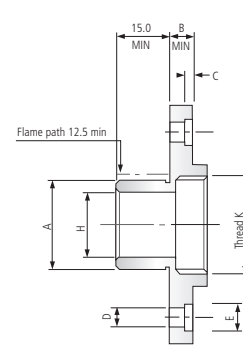
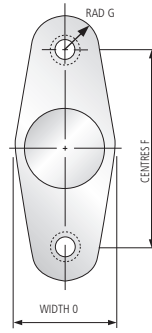

MA/FT

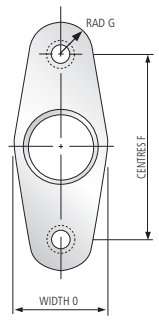

MA/FT

MA/B

MA/FT & MA/B Mining Flanged Adaptor

- Provides a conversion from spigot entry to a threaded entry
- Provides a thread size conversion if required



TECHNICAL DATA

Design Specification	BS 6121:Part 1:1989, IEC 62444, EN 62444
ATEX Certification	SIRA09ATEX1034U (MA/FT), SIRA09ATEX1035U (MA/B)
Code of Protection	IM2 Ex d I Mb
Compliance Standards	EN 60079-0,1
IECEX Certificate	IECEX SIR.09.0025U (MA/B) IECEX SIR.09.0024U (MA/FT)
Code of Protection	Ex d I Mb
Compliance Standards	IEC 60079-0,1
Ingress Protection Rating	Dependent on Cable Gland
Material	Brass, Nickel plated Brass, Stainless Steel

Cable Gland Selection Table

Refer to illustration at the top of the page.

Adaptor Size	Bore Diameter "H"	Length "B"	Thread Diameter "K"	Spigot Diameter "A"	Width "O"	Centres "F"	Diameter "D"	Diameter "E"	Bore Depth "C"	Radius "G"
20S	11.7	11.1	M20	19.05	27.0	44.45	6.6	11.5	7.0	12.7
20	14.0	11.1	M20	19.05	32.0	44.45	6.6	11.5	7.0	12.7
25S	20.2	11.1	M25	25.40	39.0	57.17	6.6	11.5	7.0	12.7
25	20.2	11.1	M25	25.40	39.0	57.17	6.6	11.5	7.0	12.7
32	26.5	12.7	M32	31.75	45.0	69.85	9.0	15.5	8.7	14.3
40	32.4	12.7	M40	38.10	52.0	82.55	9.0	15.5	8.7	14.3
50S	38.4	14.5	M50	50.80	58.0	95.25	11.0	19.0	10.5	17.5
50	44.3	14.5	M50	50.80	64.0	95.25	11.0	19.0	10.5	17.5
63S	50.3	14.5	M63	63.50	71.0	114.30	11.0	19.0	10.5	17.5
63	56.2	14.5	M63	63.50	76.0	114.30	11.0	19.0	10.5	17.5
75S	62.2	18.0	M75	76.20	83.0	127.00	14.0	21.0	13.5	17.5
75	68.2	18.0	M75	76.20	88.0	127.00	14.0	21.0	13.5	17.5

Dimensions are displayed in millimetres unless otherwise stated

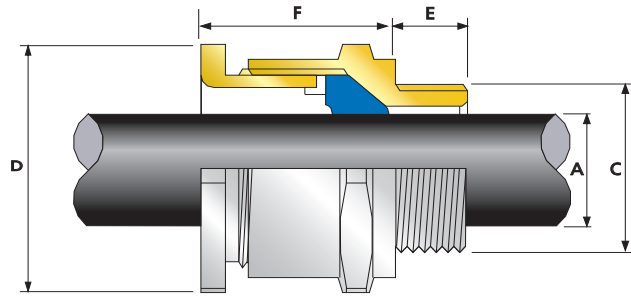

A2F/M



A2F/M Mining, Internationally Approved, Explosive Atmosphere Cable Gland

For all types of Unarmoured Cables

- High quality durable materials
- Wide sealing range for each cable gland size
- Displacement type flameproof seal
- -60°C to +130°C
- Internationally marked, IECEx & ATEX



TECHNICAL DATA	
Design Specification	BS 6121:Part 1:1989, IEC 62444, EN 62444 (A2F/M Only)
Mechanical Classifications*	Impact = Level 8, Cable Anchorage = Class B
Enclosure Protection	IK10 to IEC 62262 (20 joules) Brass & Stainless Steel only
ATEX Certificate	SIRA13ATEX1068X
Code of Protection	⊕ IM2 Ex d I Mb, Ex e I Mb
Compliance Standards	EN 60079-0,1,7
IECEx Certificate	IECEx SIR 13.0023X, IECEx SIM 14.0006
Code of Protection	Ex d I Mb, Ex e I Mb
Compliance Standards	IEC 60079-0,1,7
Ingress Protection Rating**	IP66, IP67 & IP68***
Cable Gland Material	Brass, Electroless Nickel Plated Brass, Stainless Steel
Seal Material	CMP SOLO LSF Halogen Free Thermoset Elastomer
Cable Type	Unarmoured
Sealing Technique	CMP Unique Displacement Seal Concept
Sealing Area(s)	Cable Outer Sheath

* Mechanical & Electrical Classifications applied as per IEC 62444 & EN 62444
 ** When CMP installation accessories are used. Refer to page 7 or www.cmp-products.com for further information.
 *** IP68 tested to a minimum depth of 30 metres for 12 hours, alternate depths / durations can be provided upon request

Cable Gland Selection Table

Refer to illustration at the top of the page.

Dimensions listed below are for metric cable glands only
 Dimensions for alternative threads may vary, please see supplementary technical data sheet

Cable Gland Size	Available Entry Threads "C" (Alternate Metric Thread Lengths Available)					Overall Cable Diameter "A"		Across Flats "D"	Across Corners "D"	Protrusion Length "F"	Combined Ordering Reference (*Brass Metric)			Shroud	Cable Gland Weight (Kgs)
	Standard				Option	Min	Max	Max	Max		Size	Type	Ordering Suffix		
	Metric	Thread Length (Metric) "E"	NPT	Thread Length (NPT)	NPT										
20S16	M20	15.0	½"	19.9	¾"	3.2	8.7	24.0	26.4	25.1	20S16	A2F	1RA/M	PVC04	0.07
20S	M20	15.0	½"	19.9	¾"	6.1	11.7	24.0	26.4	25.1	20S	A2F	1RA/M	PVC04	0.06
20	M20	15.0	½"	19.9	¾"	6.5	14.0	27.0	29.7	27.2	20	A2F	1RA/M	PVC05	0.07
25	M25	15.0	¾"	20.2	1"	11.1	20.0	36.0	39.6	35.5	25	A2F	1RA/M	PVC09	0.13
32	M32	15.0	1"	25.0	1 ¼"	17.0	26.3	41.0	45.1	34.2	32	A2F	1RA/M	PVC10	0.15
40	M40	15.0	1 ¼"	25.6	1 ½"	23.5	32.2	50.0	55.0	35.1	40	A2F	1RA/M	PVC13	0.20
50S	M50	15.0	1 ½"	26.1	2"	31.0	38.2	55.0	60.5	32.0	50S	A2F	1RA/M	PVC15	0.26
50	M50	15.0	2"	26.9	2 ½"	35.6	44.0	60.0	66.0	36.3	50	A2F	1RA/M	PVC18	0.27
63S	M63	15.0	2"	26.9	2 ½"	41.5	49.9	70.5	77.6	33.5	63S	A2F	1RA/M	PVC21	0.43
63	M63	15.0	2 ½"	39.9	3"	47.2	55.9	75.0	82.5	35.8	63	A2F	1RA/M	PVC23	0.40
75S	M75	15.0	2 ½"	39.9	3"	54.0	61.9	80.0	88.0	34.2	75S	A2F	1RA/M	PVC24	0.52
75	M75	15.0	3"	41.5	3 ½"	61.1	67.9	84.0	92.4	40.6	75	A2F	1RA/M	PVC26	0.50
90	M90	24.0	3 ½"	42.8	4"	66.6	79.9	108.0	118.8	58.3	90	A2F	1RA/M	PVC31	1.60
100	M100	24.0	3 ½"	42.8	4"	76.0	91.0	123.0	135.3	55.2	100	A2F	1RA/M	LSF33	1.78
115	M115	24.0	4"	44.0	5"	86.0	97.9	133.4	146.7	65.2	115	A2F	1RA/M	LSF34	2.67
130	M130	24.0	5"	46.8	-	97.0	114.9	152.4	167.6	73.9	130	A2F	1RA/M	LSF35	3.80

*For material options add the following suffix to the Ordering Reference; Brass (no suffix required); Nickel Plated Brass 'S'; 316 Grade Stainless Steel '4'; Copper Free Aluminium '1'
 For NPT options add the following digits to the material suffix; ½" = 31; ¾" = 32; 1" = 33; 1 ¼" = 34; 1 ½" = 35; 2" = 36; 2 ½" = 37; 3" = 38; 3 ½" = 39; 4" = 310 (Brass requires prefix '0')
 Examples: 32A2F1RA/MS34 = Nickel Plated Brass 1 ¼" NPT, 50SA2F1RA/M035 = Brass 1 ½" NPT, 25A2F1RA/M432 = Stainless Steel ¾" NPT, 20A2F1RA/MS = Nickel Plated Brass M20

Dimensions are displayed in millimetres unless otherwise stated

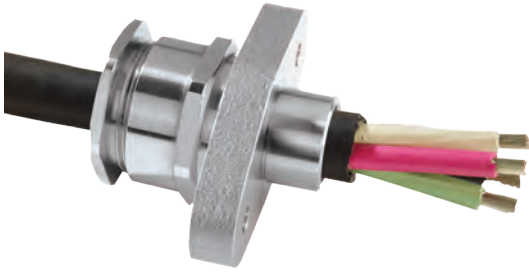

A2F/MF



A2F/MF Mining, Internationally Approved, Flanged Explosive Atmosphere Cable Gland

For all types of Unarmoured Cables

- Complete with flanged adaptor
- High quality durable materials
- Wide sealing range for each cable gland size
- Displacement type flameproof seal
- -60°C to +130°C
- Internationally marked, IECEx & ATEX



See MA/FT, MA/B page for flange mounting dimensions

Alternative flange sizes available upon request

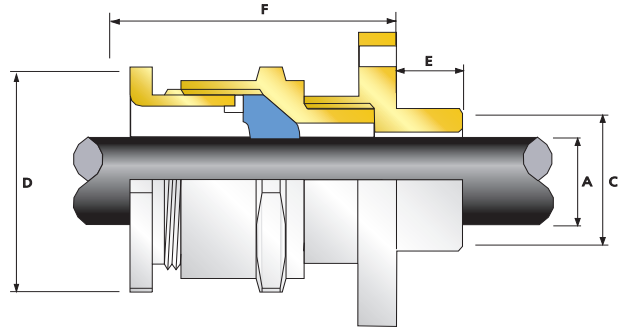

TECHNICAL DATA	
Design Specification	BS 6121:Part 1:1989, IEC 62444, EN 62444 (A2F/M Only)
Mechanical Classifications*	Impact = Level 8, Cable Anchorage = Class B
Enclosure Protection	IK10 to IEC 62262 (20 joules) Brass & Stainless Steel only
ATEX Certificate	SIRA13ATEX1068X, SIRA09ATEX1034U
Code of Protection	Ⓜ IM2 Ex d I Mb, Ex e I Mb
Compliance Standards	EN 60079-0,1,7
IECEx Certificate	IECEx SIR 13.0023X, IECEx SIR 09.0024U, IECEx SIM 14.0006
Code of Protection	Ex d I Mb, Ex e I Mb
Compliance Standards	IEC 60079-0,1,7
Ingress Protection Rating**	IP67, IP66 & IP68***
Cable Gland Material	Brass, Electroless Nickel Plated Brass, Stainless Steel
Seal Material	CMP SOLO LSF Halogen Free Thermoset Elastomer
Cable Type	Unarmoured
Sealing Technique	CMP Unique Displacement Seal Concept
Sealing Area(s)	Cable Outer Sheath

* Mechanical & Electrical Classifications applied as per IEC 62444 & EN 62444
 ** When CMP installation accessories are used. Refer to page 7 or www.cmp-products.com for further information.
 *** IP68 tested to a minimum depth of 30 metres for 12 hours, alternate depths / durations can be provided upon request

Cable Gland Selection Table

Refer to illustration at the top of the page.

Cable Gland Size	Spigot Diameter "C"	Minimum Spigot Length "E"	Overall Cable Diameter "A"		Across Flats "D"	Across Corners "D"	Protrusion Length "F"	Combined Ordering Reference (*Brass Metric)			Cable Gland Weight (Kgs)
			Min	Max	Max	Max		Size	Type	Ordering Suffix	
20S	19.0	15.0	6.1	11.7	22.0	24.2	32.1	20S	A2F	1RA/MF	0.074
20	19.0	15.0	6.5	14.0	27.0	29.7	32.1	20	A2F	1RA/MF	0.079
25	25.4	15.0	11.1	20.0	36.0	39.6	35.1	25	A2F	1RA/MF	0.100
32	31.8	15.0	17.0	26.3	41.0	45.1	38.7	32	A2F	1RA/MF	0.438
40	38.1	15.0	23.5	32.2	46.0	50.6	39.7	40	A2F	1RA/MF	0.620
50S	50.8	15.0	31.0	38.2	55.0	60.5	42.5	50S	A2F	1RA/MF	0.730
50	50.8	15.0	35.6	44.0	60.0	66.0	43.5	50	A2F	1RA/MF	0.800
63S	63.5	15.0	41.5	49.9	65.0	71.5	44.5	63S	A2F	1RA/MF	1.040
63	63.5	15.0	47.2	55.9	70.0	77.0	44.5	63	A2F	1RA/MF	1.060
75S	76.2	15.0	54.0	61.9	84.0	92.4	48.0	75S	A2F	1RA/MF	1.220
75	76.2	15.0	61.1	67.9	84.0	92.4	50.0	75	A2F	1RA/MF	1.350

*For material options add the following suffix to the Ordering Reference; Brass (no suffix required); Nickel Plated Brass 'S'; 316 Grade Stainless Steel '4'; Copper Free Aluminium '1'
 For NPT options please add the following digits to the material suffix; 1/2" = 31, 3/4" = 32, 1" = 33, 1 1/4" = 34, 1 1/2" = 35, 2" = 36, 2 1/2" = 37, 3" = 38, 3 1/2" = 39 (Brass requires prefix "0")

Examples: 32A2F1RA/MF534 = Nickel Plated Brass 1 1/4" NPT, 50SA2F1RA/MF035 = Brass 1 1/2" NPT, 25A2F1RA/MF432 = Stainless Steel 3/4" NPT, 20A2F1RA/MF5 = Nickel Plated Brass M20

Dimensions are displayed in millimetres unless otherwise stated

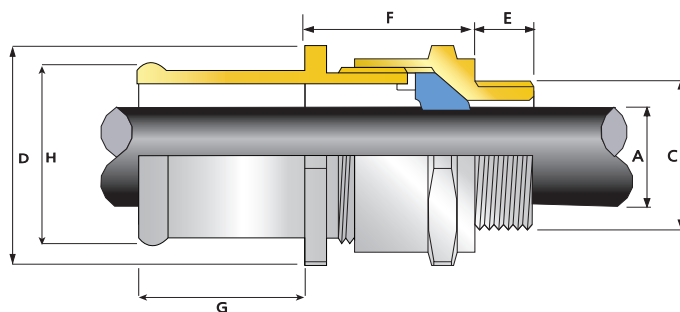

A2F/HC



A2F/HC Mining & Overground, Internationally Approved, Explosive Atmosphere Cable Gland

For all types of Unarmoured Cables housed in Flexible Hose

- Standard material nickel plated brass
- Suitable for QLD & NSW coal mining applications
- External Hose connection facility
- Approved for Group I & Group II
- High quality durable materials
- Wide sealing range for each cable gland size
- Displacement type flameproof seal
- -60°C to +130°C
- Internationally marked, IECEx & ATEX



Available for Group I & II use

Contact CMP for specific Group I & II Certification

TECHNICAL DATA

Design Specification	BS 6121:Part 1:1989, IEC 62444, EN 62444
Mechanical Classifications*	Impact = Level 8, Cable Anchorage = Class B
Enclosure Protection	IK10 to IEC 62262 (20 joules) Brass & Stainless Steel only
ATEX Certificate	SIRA13ATEX1068X, SIRA13ATEX4074X
Code of Protection	⊕ Ex d IIC Gb, Ex e IIC Gb, Ex nR IIC Gc, Ex ta IIIC Da (Group II) ⊕ Ex d I Mb, Ex e I Mb (Group I)
Compliance Standards	EN 60079-0,1,7,15,31
IECEx Certificate	IECEx SIR 13.0023X, IECEx SIM 14.0006
Code of Protection	Ex d IIC Gb, Ex e IIC Gb, Ex nR IIC Gc, Ex ta IIIC Da (Group II) Ex d I Mb, Ex e I Mb (Group I)
Compliance Standards	IEC 60079-0,1,7,15,31
EAC Certificate	TC C-GB. 05.B00138 (Group II)
KCC Certificate	13-GA4B0-0748X, 13-GA4B0-0749X, 13-GA4B0-0750X (Group II)
CCOE / PESO (India) Certificate	P333688 (Group II)
NEPSI Certificate	GYJ13.1140X / GYJ13.1282X (Group II)
INMETRO Approval	TUV 12.0878X (Group II)
Ingress Protection Rating**	IP66, IP67 & IP68***
Deluge Protection Compliance	DTS01 : 91
Cable Gland Material	Electroless Nickel Plated Brass (standard), Stainless Steel, Aluminium
Seal Material	CMP SOLO LSF Halogen Free Thermoset Elastomer
Cable Type	Unarmoured & enclosed within hose for mechanical protection
Sealing Technique	CMP Displacement Seal
Sealing Area(s)	Cable Outer Sheath

* Mechanical & Electrical Classifications applied as per IEC 62444 & EN 62444
 ** When CMP installation accessories are used. Refer to page 7 or www.cmp-products.com for further information.
 *** IP68 tested to a minimum depth of 30 metres for 12 hours, alternate depths / durations can be provided upon request

Cable Gland Selection Table

Refer to illustration at the top of the page.

Dimensions listed below are for metric cable glands only
 Dimensions for alternative threads may vary, please see supplementary technical data sheet

Cable Gland Size	Hose Diameter "H"	Standard Metric Entry Threads "C"	Minimum Thread Length "E"	Overall Cable Diameter "A"		Across Flats "D"	Across Corners "D"	Protrusion Length "F"	Hose Connection Length "G"	Combined Ordering Reference (*Brass Metric)			Cable Gland Weight (Kgs)
				Min	Max	Max	Max			Size	Type	Ordering Suffix	
20S16	13.0	M20	15.0	3.2	8.7	24.0	26.4	26.6	16.0	20S16	A2FHC13	1RA	0.100
20S16	16.0	M20	15.0	3.2	8.7	24.0	26.4	26.6	16.0	20S16	A2FHC16	1RA	0.110
20S	16.0	M20	15.0	6.1	11.7	24.0	26.4	26.6	16.0	20S	A2FHC16	1RA	0.090
20	19.0	M20	15.0	6.5	14.0	27.0	29.7	29.0	20.0	20	A2FHC19	1RA	0.110
25	19.0	M25	15.0	11.1	20.0	36.0	39.6	37.3	20.0	25	A2FHC19	1RA	0.210
25	25.0	M25	15.0	11.1	20.0	36.0	39.6	37.3	27.0	25	A2FHC25	1RA	0.210
32	25.0	M32	15.0	17.0	26.3	41.0	45.1	36.2	27.0	32	A2FHC25	1RA	0.270
32	32.0	M32	15.0	17.0	26.3	41.0	45.1	36.2	33.0	32	A2FHC32	1RA	0.270
40	38.0	M40	15.0	23.5	32.2	50.0	55.0	36.6	41.0	40	A2FHC38	1RA	0.380
50S	51.0	M50	15.0	31.0	38.2	55.0	60.5	34.0	54.0	50S	A2FHC51	1RA	0.740
50	51.0	M50	15.0	35.6	44.0	60.0	66.0	37.8	54.0	50	A2FHC51	1RA	0.570
63S	63.0	M63	15.0	41.5	49.9	70.5	77.6	33.0	70.0	63S	A2FHC63	1RA	1.210
63	63.0	M63	15.0	47.2	55.9	75.0	84.0	36.5	70.0	63	A2FHC63	1RA	0.860
75S	76.0	M75	15.0	54.0	61.9	84.0	92.4	33.4	91.5	75S	A2FHC76	1RA	1.760
75	76.0	M75	15.0	61.1	67.9	85.0	93.5	38.7	91.5	75	A2FHC76	1RA	1.260

Dimensions are displayed in millimetres unless otherwise stated

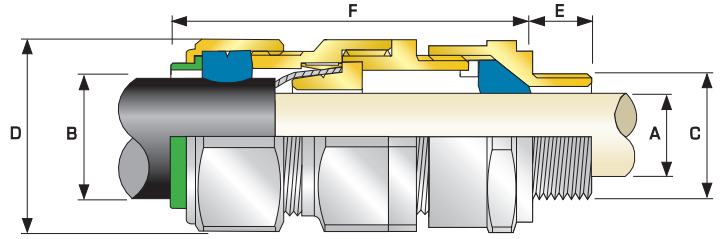

E1FX/M



E1FX/M Mining, Internationally Approved, Explosive Atmosphere Cable Gland

For Pliable Wire Armoured cables

- High quality durable materials
- Wide sealing range for each cable gland size
- Fully sequential, three step installation procedure
- Reduces subjectivity of installations
- Metal-to-metal armour clamping
- Direct & remote installation
- Displacement type flameproof inner seal
- Controlled outer 'load retention' seal
- Unique OSTG prevents overtightening
- -60°C to +130°C
- Permitted in Zone 1
- Internationally marked, IECEx & ATEX
- Superior EMC performance



TECHNICAL DATA	
Design Specification	BS 6121:Part 1:1989, IEC 62444, EN 62444
Mechanical Classifications*	Impact = Level 8, Cable Anchorage = Class D
Enclosure Protection	IK10 to IEC 62262 (20 joules) Brass & Stainless Steel only
Electrical Classifications*	Category B
ATEX Certificate	SIRA13ATEX1071X
Code of Protection	⊕ IM2 Ex d I Mb, Ex e I Mb
Compliance Standards	EN 60079-0,1,7
IECEx Certificate	IECEx SIR 13.0026X, IECEx SIM 14.0007X
Code of Protection	Ex d I Mb, Ex e I Mb
Compliance Standards	IEC 60079-0,1,7
Ingress Protection Rating**	IP66 as standard (IP67, IP68*** available upon request)
Cable Gland Material	Brass, Electroless Nickel Plated Brass
Seal Material	CMP SOLO LSF Halogen Free Thermoset Elastomer
Cable Type	Pliable Wire Armour (PWA)
Armour Clamping	Detachable Armour Cone & AnyWay Universal Clamping Ring
Sealing Technique	CMP Inner Displacement Seal & Unique CMP 'LRS'™ Outer Load Retention Seal
Sealing Area(s)	Cable Inner Bedding & Outer Cable Sheath

* Mechanical & Electrical Classifications applied as per IEC 62444 & EN 62444
 ** When CMP installation accessories are used. Refer to page 7 or www.cmp-products.com for further information.
 *** IP68 tested to a minimum depth of 30 metres for 12 hours, alternate depths / durations can be provided upon request

Cable Gland Selection Table

Refer to illustration at the top of the page.

Dimensions listed below are for metric cable glands only
 Dimensions for alternative threads may vary, please see supplementary technical data sheet

Cable Gland Size	Available Entry Threads "C" (Alternate Metric Thread Lengths Available)					Cable Bedding Diameter "A"		Overall Cable Diameter "B"		Pliable Armour Wire		Across Flats "D"	Across Corners "D"	Protrusion Length "E"	Combined Ordering Reference (*Brass Metric)			Shroud	Cable Gland Weight (Kgs)
	Standard				Option	Min	Max	Min	Max	Min	Max	Max	Max		Size	Type	Ordering Suffix		
	Metric	Thread Length (Metric) "E"	NPT	Thread Length (NPT) "E"	NPT														
20S16	M20	15.0	½"	19.9	¾"	3.1	8.6	6.1	13.1	0.0	7/0.45	24.0	26.4	72.5	20S16	E1FX	1RA/M	PVC04	0.157
20S	M20	15.0	½"	19.9	¾"	6.1	11.6	9.5	15.9	0.0	7/0.45	24.0	26.4	70.0	20S	E1FX	1RA/M	PVC04	0.157
20	M20	15.0	½"	19.9	¾"	6.5	13.9	12.5	20.9	0.0	7/0.45	30.5	33.6	73.0	20	E1FX	1RA/M	PVC06	0.206
25S5	M25	15.0	¾"	20.2	1"	11.1	19.9	14.0	22.0	0.0	7/0.45	37.5	41.3	89.0	25S	E1FX	1RA/M	PVC09	0.325
25	M25	15.0	¾"	20.2	1"	11.1	19.9	18.2	26.2	0.0	7/0.45	37.5	41.3	89.0	25	E1FX	1RA/M	PVC09	0.325
32	M32	15.0	1"	25.0	1 ¼"	17.0	26.2	23.7	33.9	0.0	7/0.45	46.0	50.6	86.0	32	E1FX	1RA/M	PVC11	0.430
40	M40	15.0	1 ¼"	25.6	1 ½"	22.0	32.1	27.9	40.4	0.0	7/0.71	55.0	60.5	90.0	40	E1FX	1RA/M	PVC15	0.620
50S	M50	15.0	1 ½"	26.1	2"	29.5	38.1	35.2	46.7	0.0	7/0.71	60.0	66.0	91.0	50S	E1FX	1RA/M	PVC18	0.750
50	M50	15.0	2"	26.9	2 ½"	35.6	44.0	40.4	53.0	0.0	7/0.71	70.1	77.1	95.0	50	E1FX	1RA/M	PVC21	0.950
63S	M63	15.0	2"	26.9	2 ½"	40.1	49.9	45.6	59.4	0.0	7/0.71	75.0	82.5	102.0	63S	E1FX	1RA/M	PVC23	1.337
63	M63	15.0	2 ½"	39.9	3"	47.2	55.9	54.6	65.8	0.0	7/0.71	80.0	88.0	104.0	63	E1FX	1RA/M	PVC25	1.340
75S	M75	15.0	2 ½"	39.9	3"	52.8	61.9	59.0	72.0	0.0	7/0.71	90.0	99.0	115.0	75S	E1FX	1RA/M	PVC28	2.110
75	M75	15.0	3"	41.5	3 ½"	59.1	67.9	66.7	78.4	0.0	7/0.71	100.0	110.0	117.0	75	E1FX	1RA/M	PVC30	2.420

*For material options add the following suffix to the Ordering Reference; Brass (no suffix required); Nickel Plated Brass 'S'; 316 Grade Stainless Steel '4'; Copper Free Aluminium '1'
 For NPT options add the following digits to the material suffix; ½" = 31; ¾" = 32; 1" = 33; 1 ¼" = 34; 1 ½" = 35; 2" = 36; 2 ½" = 37; 3" = 38; 3 ½" = 39; 4" = 310 (Brass requires prefix '0')

Examples: 32E1FXM1RA534 = Nickel Plated Brass 1 ¼" NPT, 50SE1FXM1RA035 = Brass 1 ½" NPT, 25E1FXM1RA432 = Stainless Steel ¾" NPT, 20E1FXM1RA5 = Nickel Plated Brass M20

Dimensions are displayed in millimetres unless otherwise stated

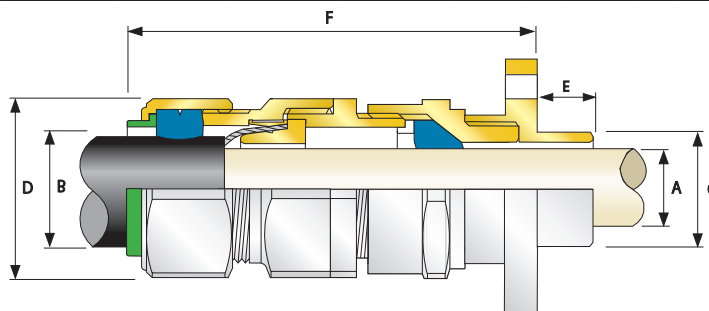

E1FX/MF



E1FX/MF Mining, Internationally Approved, Flanged Explosive Atmosphere Cable Gland

For Pliable Wire Armoured cables

- High quality durable materials
- Wide sealing range for each cable gland size
- Fully sequential, three step installation procedure
- Reduces subjectivity of installations
- Complete with flanged adaptor
- Metal-to-metal armour clamping
- Direct & remote installation
- Displacement type flameproof inner seal
- Controlled outer 'load retention' seal
- Unique OSTG prevents overtightening
- -60°C to +130°C
- Permitted in Zone 1
- Internationally marked, IECEx & ATEX
- Superior EMC performance



See MAIFT, MAIB page for flange mounting dimensions

Alternative flange sizes available upon request

TECHNICAL DATA	
Design Specification	BS 6121:Part 1:1989, IEC 62444, EN 62444
Mechanical Classifications*	Impact = Level 8, Cable Anchorage = Class D
Enclosure Protection	IK10 to IEC 62262 (20 joules) Brass & Stainless Steel only
Electrical Classifications*	Category B
ATEX Certificate	SIRA13ATEX1071X, SIRA09ATEX1034U
Code of Protection	IM2 Ex d I Mb, Ex e I Mb
Compliance Standards	EN 60079-0,1,7
IECEx Certificate	IECEx SIR 13.0026X, IECEx SIR 09.0024U, IECEx SIM 14.0007X
Code of Protection	Ex d I Mb, Ex e I Mb
Compliance Standards	IEC 60079-0,1,7
Ingress Protection Rating**	IP66
Cable Gland Material	Brass, Electroless Nickel Plated Brass
Seal Material	CMP SOLO LSF Halogen Free Thermoset Elastomer
Cable Type	Pliable Armour Wire (PWA)
Armour Clamping	Detachable Armour Cone & AnyWay Universal Clamping Ring
Sealing Technique	CMP Inner Displacement Seal & Unique CMP 'LRS'™ Outer Load Retention Seal
Sealing Area(s)	Cable Inner Bedding & Outer Cable Sheath

* Mechanical & Electrical Classifications applied as per IEC 62444 & EN 62444

** When CMP installation accessories are used. Refer to page 7 or www.cmp-products.com for further information.

Cable Gland Selection Table

Refer to illustration at the top of the page.

Cable Gland Size	Minimum Spigot Length "E"	Spigot Diameter "C"	Cable Bedding Diameter "A"		Overall Cable Diameter "B"		Pliable Wire Diameter		Across Flats "D"	Across Corners "D"	Protrusion Length "F"	Combined Ordering Reference (*Brass Metric)			Cable Gland Weight (Kgs)
			Min	Max	Min	Max	Min	Max				Max	Max	Size	
20S	15.0	19.0	6.1	11.6	9.5	15.9	0.0	7/0.45	24.0	26.4	89.5	20S	E1FX	1RA/MF	0.302
20	15.0	19.0	6.5	13.9	12.5	20.9	0.0	7/0.45	30.5	33.6	92.5	20	E1FX	1RA/MF	0.361
25S	15.0	25.4	11.1	19.9	14.0	22.0	0.0	7/0.45	37.5	41.3	109.6	25S	E1FX	1RA/MF	0.575
25	15.0	25.4	11.1	19.9	18.2	26.2	0.0	7/0.45	37.5	41.3	109.6	25	E1FX	1RA/MF	0.572
32	15.0	31.8	17.0	26.2	23.7	33.9	0.0	7/0.45	46.0	50.6	107.2	32	E1FX	1RA/MF	0.745
40	15.0	38.1	22.0	32.1	27.9	40.4	0.0	7/0.71	55.0	60.5	111.2	40	E1FX	1RA/MF	1.015
50S	15.0	50.8	29.5	38.1	35.2	46.7	0.0	7/0.71	60.0	66.0	109.0	50S	E1FX	1RA/MF	1.478
50	15.0	50.8	35.6	44.0	40.4	53.0	0.0	7/0.71	70.1	77.1	113.0	50	E1FX	1RA/MF	1.683
63S	15.0	63.5	40.1	49.9	45.6	59.4	0.0	7/0.71	75.0	82.5	120.5	63S	E1FX	1RA/MF	2.109
63	15.0	63.5	47.2	55.9	54.6	65.8	0.0	7/0.71	80.0	88.0	122.5	63	E1FX	1RA/MF	2.149
75S	15.0	76.2	52.8	61.9	59.0	72.0	0.0	7/0.71	90.0	99.0	142.5	75S	E1FX	1RA/MF	3.664
75	15.0	76.2	59.1	67.9	66.7	78.4	0.0	7/0.71	100.0	110.0	144.5	75	E1FX	1RA/MF	3.978

*Note : For material options please add the following suffix to change the Ordering Reference ; Brass (no suffix required), Nickel Plated Brass "5" 316 Grade Stainless Steel "4", Copper Free Aluminium "1"

Examples: 32E1FXMF1RA = Brass, 50SE1FXMF1RA5 = Nickel Plated Brass, 25E1FXMF1RA4 = Stainless Steel

Dimensions are displayed in millimetres unless otherwise stated

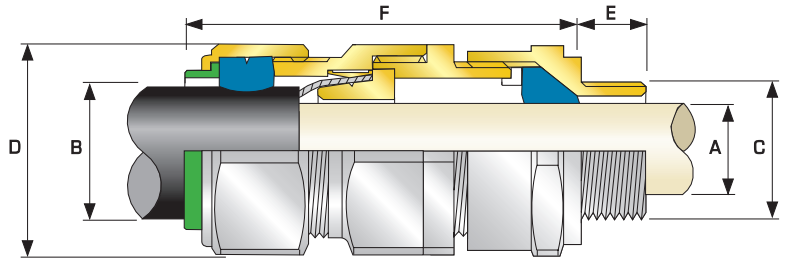

E1FW/M



E1FW/M Mining, Internationally Approved, Explosive Atmosphere Cable Gland

For all types Steel & Aluminium Wire Armoured cables

- High quality durable materials
- Wide sealing range for each cable gland size
- Fully sequential, three step installation procedure
- Reduces subjectivity of installations
- Metal-to-metal armour clamping
- Direct & remote installation
- Displacement type flameproof inner seal
- Controlled outer 'load retention' seal
- Unique OSTG prevents overtightening
- -60°C to +130°C
- Permitted in Zone 1
- Internationally marked, IECEx & ATEX
- Superior EMC performance

TECHNICAL DATA

Design Specification	BS 6121:Part 1:1989, IEC 62444, EN 62444
Mechanical Classifications*	Impact = Level 8, Cable Anchorage = Class D
Enclosure Protection	IK10 to IEC 62262 (20 joules) Brass & Stainless Steel only
Electrical Classifications*	Category B
ATEX Certificate	SIRA13ATEX1071X
Code of Protection	⊕ IM2 Ex d I Mb, Ex e I Mb
Compliance Standards	EN60079-0,1,7
IECEx Certificate	IECEx SIR 13.0026X, IECEx SIM 14.0007X
Code of Protection	Ex d I Mb, Ex e I Mb
Compliance Standards	IEC 60079-0,1,7
Ingress Protection Rating**	IP66 as standard (IP67, IP68*** available upon request)
Cable Gland Material	Brass, Electroless Nickel Plated Brass
Seal Material	CMP SOLO LSF Halogen Free Thermoset Elastomer
Cable Type	Single Wire Armour (SWA), Aluminium Wire Armour (AWA)
Armour Clamping	Detachable Armour Cone & AnyWay Universal Clamping Ring
Sealing Technique	CMP Inner Displacement Seal & Unique CMP 'LRS'™ Outer Load Retention Seal
Sealing Area(s)	Cable Inner Bedding & Outer Cable Sheath

* Mechanical & Electrical Classifications applied as per IEC 62444 & EN 62444

** When CMP installation accessories are used. Refer to page 7 or www.cmp-products.com for further information.

*** IP68 tested to a minimum depth of 30 metres for 12 hours, alternate depths / durations can be provided upon request



Cable Gland Selection Table

Refer to illustration at the top of the page.

Dimensions listed below are for metric cable glands only
Dimensions for alternative threads may vary, please see supplementary technical data sheet

Cable Gland Size	Available Entry Threads "C" (Alternate Metric Thread Lengths Available)					Cable Bedding Diameter "A"		Overall Cable Diameter "B"		Armour Range		Across Flats "D"	Across Corners "D"	Protrusion Length "F"	Combined Ordering Reference (*Brass Metric)			Shroud	Cable Gland Weight (Kgs)
	Standard				Option	Min	Max	Min	Max	Min	Max	Max	Max		Size	Type	Ordering Suffix		
	Metric	Thread Length (Metric) "E"	NPT	Thread Length (NPT) "E"	NPT														
20S16	M20	15.0	½"	19.9	¾"	3.1	8.6	6.1	13.1	0.8	1.25	24.0	26.4	72.5	20S16	E1FW	1RA/M	PVC04	0.157
20S	M20	15.0	½"	19.9	¾"	6.1	11.6	9.5	15.9	0.8	1.25	24.0	26.4	70.0	20S	E1FW	1RA/M	PVC04	0.157
20	M20	15.0	½"	19.9	¾"	6.5	13.9	12.5	20.9	0.8	1.25	30.5	33.6	73.0	20	E1FW	1RA/M	PVC06	0.206
25S	M25	15.0	¾"	20.2	1"	11.1	19.9	14.0	22.0	1.25	1.6	37.5	41.3	89.0	25S	E1FW	1RA/M	PVC09	0.325
25	M25	15.0	¾"	20.2	1"	11.1	19.9	18.2	26.2	1.25	1.6	37.5	41.3	89.0	25	E1FW	1RA/M	PVC09	0.325
32	M32	15.0	1"	25.0	1 ¼"	17.0	26.2	23.7	33.9	1.6	2.0	46.0	50.6	86.0	32	E1FW	1RA/M	PVC11	0.430
40	M40	15.0	1 ¼"	25.6	1 ½"	22.0	32.1	27.9	40.4	1.6	2.0	55.0	60.5	90.0	40	E1FW	1RA/M	PVC15	0.620
50S	M50	15.0	1 ½"	26.1	2"	29.5	38.1	35.2	46.7	2.0	2.5	60.0	66.0	91.0	50S	E1FW	1RA/M	PVC18	0.750
50	M50	15.0	2"	26.9	2 ½"	35.6	44.0	40.4	53.0	2.0	2.5	70.1	77.1	95.0	50	E1FW	1RA/M	PVC21	0.950
63S	M63	15.0	2"	26.9	2 ½"	40.1	49.9	45.6	59.4	2.0	2.5	75.0	82.5	102.0	63S	E1FW	1RA/M	PVC23	1.337
63	M63	15.0	2 ½"	39.9	3"	47.2	55.9	54.6	65.8	2.0	2.5	80.0	88.0	104.0	63	E1FW	1RA/M	PVC25	1.340
75S	M75	15.0	2 ½"	39.9	3"	52.8	61.9	59.0	72.0	2.0	2.5	90.0	99.0	115.0	75S	E1FW	1RA/M	PVC28	2.110
75	M75	15.0	3"	41.5	3 ½"	59.1	67.9	66.7	78.4	2.5	3.0	100.0	110.0	117.0	75	E1FW	1RA/M	PVC30	2.420

*For material options add the following suffix to the Ordering Reference, Brass (no suffix required); Nickel Plated Brass '5'; 316 Grade Stainless Steel '4'; Copper Free Aluminium '1'
For NPT options add the following digits to the material suffix, ½" = 31, ¾" = 32, 1" = 33, 1 ¼" = 34, 1 ½" = 35, 2" = 36, 2 ½" = 37, 3" = 38, 3 ½" = 39, 4" = 310 (Brass requires prefix '0')

Examples: 32E1FWM1RA534 = Nickel Plated Brass 1 ¼" NPT, 50SE1FWM1RA035 = Brass 1 ½" NPT, 25E1FWM1RA432 = Stainless Steel ¾" NPT, 20E1FWM1RA5 = Nickel Plated Brass M20

Dimensions are displayed in millimetres unless otherwise stated

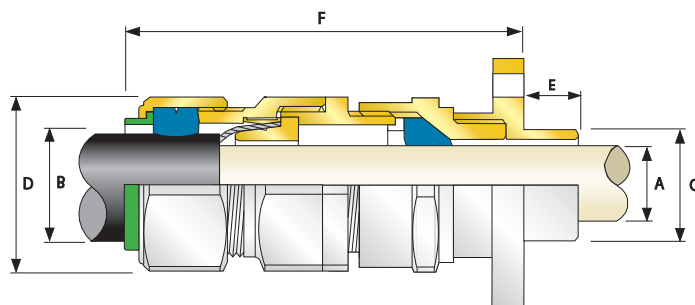

E1FW/MF



E1FW/MF Mining, Internationally Approved, Flanged Explosive Atmosphere Cable Gland

For all types Steel & Aluminium Wire Armoured cables

- High quality durable materials
- Wide sealing range for each cable gland size
- Fully sequential, three step installation procedure
- Reduces subjectivity of installations
- Complete with flanged adaptor
- Metal-to-metal armour clamping
- Direct & remote installation
- Displacement type flameproof inner seal
- Controlled outer 'load retention' seal
- Unique OSTG prevents overtightening
- -60°C to +130°C
- Permitted in Zone 1
- Internationally marked, IECEx & ATEX
- Superior EMC performance



See MA/FT, MA/B page for flange mounting dimensions

Alternative flange sizes available upon request

TECHNICAL DATA	
Design Specification	BS 6121:Part 1:1989, IEC 62444, EN 62444
Mechanical Classifications*	Impact = Level 8, Cable Anchorage = Class D
Enclosure Protection	IK10 to IEC 62262 (20 joules) Brass & Stainless Steel only
Electrical Classifications*	Category B
ATEX Certificate	SIRA13ATEX1072X, SIRA09ATEX1034U
Code of Protection	⊕ IM2 Ex d I Mb, Ex e I Mb
Compliance Standards	EN60079-0,1,7
IECEx Certificate	IECEx SIR 13.0027X, IECEx SIR 09.0024U, IECEx SIM 14.0007X
Code of Protection	Ex d I Mb, Ex e I Mb
Compliance Standards	IEC 60079-0,1,7
Ingress Protection Rating**	IP66
Cable Gland Material	Brass, Electroless Nickel Plated Brass
Seal Material	CMP SOLO LSF Halogen Free Thermoset Elastomer
Cable Type	Single Wire Armour (SWA), Aluminium Wire Armour (AWA)
Armour Clamping	Detachable Armour Cone & AnyWay Universal Clamping Ring
Sealing Technique	CMP Inner Displacement Seal & Unique CMP 'LRS'™ Outer Load Retention Seal
Sealing Area(s)	Cable Inner Bedding & Outer Cable Sheath

* Mechanical & Electrical Classifications applied as per IEC 62444 & EN 62444
 ** When CMP installation accessories are used. Refer to page 7 or www.cmp-products.com for further information.

Cable Gland Selection Table

Refer to illustration at the top of the page.

Cable Gland Size	Minimum Spigot Length "E"	Spigot Diameter "C"	Cable Bedding Diameter "A"		Overall Cable Diameter "B"		Armour Range		Across Flats "D"	Across Corners "D"	Protrusion Length "F"	Combined Ordering Reference (*Brass Metric)			Cable Gland Weight (Kgs)
			Min	Max	Min	Max	Min	Max				Max	Max	Size	
20S	15.0	19.0	6.1	11.6	9.5	15.9	0.8	1.25	24.0	26.4	89.5	20S	E1FW	1RA/MF	0.302
20	15.0	19.0	6.5	13.9	12.5	20.9	0.8	1.25	30.5	33.6	92.5	20	E1FW	1RA/MF	0.361
25S	15.0	25.4	11.1	19.9	14.0	22.0	1.25	1.6	37.5	41.3	109.6	25S	E1FW	1RA/MF	0.575
25	15.0	25.4	11.1	19.9	18.2	26.2	1.25	1.6	37.5	41.3	109.6	25	E1FW	1RA/MF	0.572
32	15.0	31.8	17.0	26.2	23.7	33.9	1.6	2.0	46.0	50.6	107.2	32	E1FW	1RA/MF	0.745
40	15.0	38.1	22.0	32.1	27.9	40.4	1.6	2.0	55.0	60.5	111.2	40	E1FW	1RA/MF	1.015
50S	15.0	50.8	29.5	38.1	35.2	46.7	2.0	2.5	60.0	66.0	109	50S	E1FW	1RA/MF	1.478
50	15.0	50.8	35.6	44.0	40.4	53.0	2.0	2.5	70.1	77.1	113	50	E1FW	1RA/MF	1.683
63S	15.0	63.5	40.1	49.9	45.6	59.4	2.0	2.5	75.0	82.5	120.5	63S	E1FW	1RA/MF	2.109
63	15.0	63.5	47.2	55.9	54.6	65.8	2.0	2.5	80.0	88.0	122.5	63	E1FW	1RA/MF	2.149
75S	15.0	76.2	52.8	61.9	59.0	72.0	2.5	3.0	89.0	97.9	142.5	75S	E1FW	1RA/MF	3.664
75	15.0	76.2	59.1	67.9	66.7	78.4	2.5	3.0	99.0	108.9	144.5	75	E1FW	1RA/MF	3.978

*For material options add the following suffix to the Ordering Reference; Brass (no suffix required); Nickel Plated Brass '5'; 316 Grade Stainless Steel '4'; Copper Free Aluminium '1'

Examples: 32E1FWMF1RA = Brass, 50SE1FWMF1RA5 = Nickel Plated Brass, 25E1FWMF1RA4 = Stainless Steel

Dimensions are displayed in millimetres unless otherwise stated

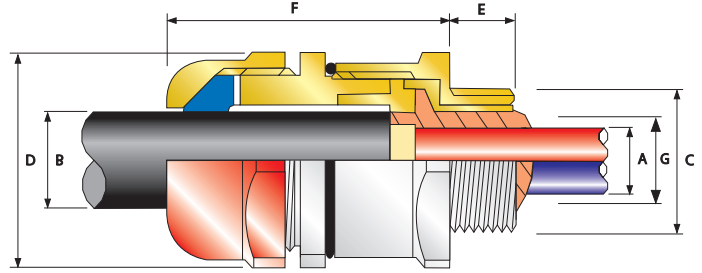

PXSS2K/M



PXSS2K/M Mining, Internationally Approved, Explosive Atmosphere Barrier Cable Gland

For all types of Unarmoured Cables

- Displacement type environmental seal
- Compound barrier type flameproof seal
- -60°C to +85°C
- Permitted in Zone 1
- Internationally marked, IECEx & ATEX



Also available with RapidEx

TECHNICAL DATA	
Design Specification	BS 6121:Part 1:1989, IEC 62444, EN 62444
Mechanical Classifications*	Impact = Level 8, Cable Anchorage = Class D
Enclosure Protection	IK10 to IEC 62262 (20 joules) Brass & Stainless Steel only
ATEX Certificate	SIRA13ATEX1072X
Code of Protection	⊕ IM2 Ex d I Mb, Ex e I Mb
Compliance Standards	EN 60079-0,1,7
IECEx Certificate	IECEx SIR 13.0027X
Code of Protection	Ex d I Mb, Ex e I Mb
Compliance Standards	IEC 60079-0,1,7
Ingress Protection Rating**	IP66, IP67 & IP68***
Deluge Protection Compliance	DTS01:91
Cable Gland Material	Brass, Electroless Nickel Plated Brass, Stainless Steel
Seal Material	CMP SOLO LSF Halogen Free Thermoset Elastomer / Epoxy Barrier Compound
Cable Type	Unarmoured
Sealing Technique	CMP Unique Displacement Seal Concept
Sealing Area(s)	Inner Compound Barrier & Outer Sheath

* Mechanical & Electrical Classifications applied as per IEC 62444 & EN 62444

** When CMP installation accessories are used. Refer to page 7 or www.cmp-products.com for further information.

*** IP68 tested to a minimum depth of 30 metres for 12 hours, alternate depths / durations can be provided upon request

Cable Gland Selection Table

Refer to illustration at the top of the page.

Cable Gland Size	Minimum Thread Length "E"	Entry Thread "C"	Maximum Diameter Over Conductors "A"	Maximum Number Of Cores	Cable Bedding Diameter "G"	Overall Cable Diameter "B"		Across Flats "D"	Across Corners "D"	Protrusion Length "F"	Combined Ordering Reference (*Brass Metric)			Shroud	Cable Gland Weight (Kgs)
			Diameter	Cores	Max	Min	Max	Max	Max		Size	Type	Ordering Suffix		
20S	15.0	M20	12.6	11	11.7	6.1	11.7	30.0	33.0	53.1	20S	PXSS2K	1RA/M	PVC06	0.200
20	15.0	M20	12.6	11	12.9	6.5	14.0	30.0	33.0	54.2	20	PXSS2K	1RA/M	PVC06	0.200
25	15.0	M25	17.5	21	17.9	11.1	20.0	36.0	39.6	60.0	25	PXSS2K	1RA/M	PVC09	0.330
32	15.0	M32	23.6	38	23.9	17.0	26.3	41.0	45.1	61.1	32	PXSS2K	1RA/M	PVC10	0.590
40	15.0	M40	30.0	59	30.3	22.0	32.1	50.0	55.0	62.4	40	PXSS2K	1RA/M	PVC13	0.560
50S	15.0	M50	36.6	89	36.9	29.5	38.2	55.0	60.5	65.2	50S	PXSS2K	1RA/M	PVC15	0.660
50	15.0	M50	41.0	89	41.3	35.6	44.0	60.0	66.0	67.6	50	PXSS2K	1RA/M	PVC18	0.730
63S	15.0	M63	47.9	115	48.4	40.1	49.9	70.0	77.0	71.1	63S	PXSS2K	1RA/M	PVC21	1.070
63	15.0	M63	53.7	115	54.0	47.2	55.9	75.0	82.5	70.4	63	PXSS2K	1RA/M	PVC23	1.060
75S	15.0	M75	59.8	140	60.2	52.8	61.9	80.0	88.0	75.3	75S	PXSS2K	1RA/M	PVC25	1.300
75	15.0	M75	64.3	140	64.2	59.1	67.9	85.0	93.5	74.9	75	PXSS2K	1RA/M	PVC27	1.300

*For material options add the following suffix to the Ordering Reference; Brass (no suffix required); Nickel Plated Brass 'S'; 316 Grade Stainless Steel '4'; Copper Free Aluminium '1'

Examples: 32PXSS2KM1RA = Brass, 50SPXSS2KM1RA5 = Nickel Plated Brass, 25PXSS2KM1RA4 = Stainless Steel

Dimensions are displayed in millimetres unless otherwise stated

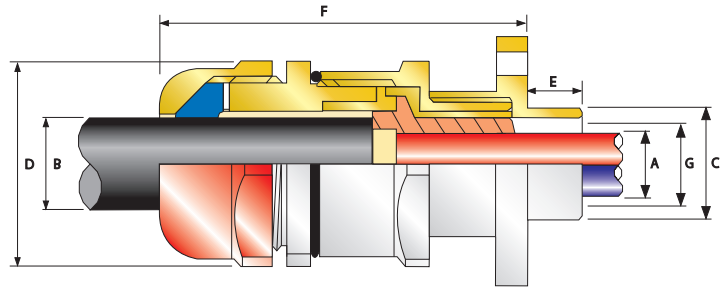

PXSS2K/MF



PXSS2K/MF Mining, Internationally Approved, Flanged Explosive Atmosphere Barrier Cable Gland

For all types of Unarmoured Cables

- Complete with flanged adaptor
- Displacement type environmental seal
- Compound barrier type flameproof seal
- -60°C to +85°C
- Permitted in Zone 1
- Internationally marked, IECEx & ATEX



See MA/FT, MA/B page for flange mounting dimensions

Alternative flange sizes available upon request

Also available with RapidEx

TECHNICAL DATA

Design Specification	BS 6121:Part 1:1989, IEC 62444, EN 62444
Mechanical Classifications*	Impact = Level 8, Cable Anchorage = Class D
Enclosure Protection	IK10 to IEC 62262 (20 joules) Brass & Stainless Steel only
ATEX Certificate	SIRA13ATEX1072X, SIRA09ATEX1034U
Code of Protection	⊕ IM2 Ex d I Mb, Ex e I Mb
Compliance Standards	EN 60079-0,1,7
IECEx Certificate	IECEx SIR 13.0027X, IECEx SIR 09.0024U
Code of Protection	Ex d I Mb, Ex e I Mb
Compliance Standards	IEC 60079-0,1,7
Ingress Protection Rating**	IP66
Cable Gland Material	Brass, Electroless Nickel Plated Brass, Stainless Steel
Seal Material	CMP SOLO LSF Halogen Free Thermoset Elastomer / Epoxy Barrier Compound
Cable Type	Unarmoured
Sealing Technique	CMP Unique Displacement Seal Concept
Sealing Area(s)	Inner Compound Barrier & Outer Sheath

* Mechanical & Electrical Classifications applied as per IEC 62444 & EN 62444

** When CMP installation accessories are used. Refer to page 7 or www.cmp-products.com for further information.

Cable Gland Selection Table

Refer to illustration at the top of the page.

Cable Gland Size	Minimum Spigot Length "E"	Spigot Diameter "C"	Number of Cores	Diameter over Conductor	Cable Bedding Diameter "A"	Overall Cable Diameter "A"		Across Flats "D"	Across Corners "D"	Protrusion Length "F"	Combined Ordering Reference (*Brass Metric)			Cable Gland Weight (Kgs)
			Max	Max	Max	Min	Max	Max	Max		Max	Size	Type	
20S	15.0	19.0	11	11.7	11.7	6.1	11.7	30.0	33.0	70.2	20S	PXSS2K	1RA/MF	0.360
20	15.0	19.0	11	12.6	12.9	6.5	14.0	30.0	33.0	71.3	20	PXSS2K	1RA/MF	0.360
25	15.0	25.4	21	17.5	17.9	11.1	20.0	36.0	39.6	80.6	25	PXSS2K	1RA/MF	0.580
32	15.0	31.8	38	23.6	23.9	17.0	26.3	41.0	45.1	82.3	32	PXSS2K	1RA/MF	0.710
40	15.0	38.1	59	30.0	30.3	22.0	32.1	50.0	55.0	90.1	40	PXSS2K	1RA/MF	0.950
50S	15.0	50.8	89	36.6	36.9	29.5	38.2	55.0	60.5	94.9	50S	PXSS2K	1RA/MF	1.400
50	15.0	50.8	89	41.0	41.3	35.6	44.0	60.0	66.0	97.3	50	PXSS2K	1RA/MF	1.470
63S	15.0	63.5	115	47.9	48.4	40.1	49.9	70.1	77.1	92.6	63S	PXSS2K	1RA/MF	1.840
63	15.0	63.5	115	53.7	54.0	47.2	55.9	75.0	82.5	89.4	63	PXSS2K	1RA/MF	1.870
75S	15.0	76.2	140	59.9	60.2	52.8	61.9	80.0	88.0	102.8	75S	PXSS2K	1RA/MF	2.860
75	15.0	76.2	140	64.2	64.2	59.1	67.9	85.0	93.5	102.4	75	PXSS2K	1RA/MF	2.860

*For material options add the following suffix to the Ordering Reference; Brass (no suffix required); Nickel Plated Brass '5'; 316 Grade Stainless Steel '4'; Copper Free Aluminium '1'

Examples: 32PXSS2KMF1RA = Brass, 50SPXSS2KMF1RA5 = Nickel Plated Brass, 25PXSS2KMF1RA4 = Stainless Steel

Dimensions are displayed in millimetres unless otherwise stated

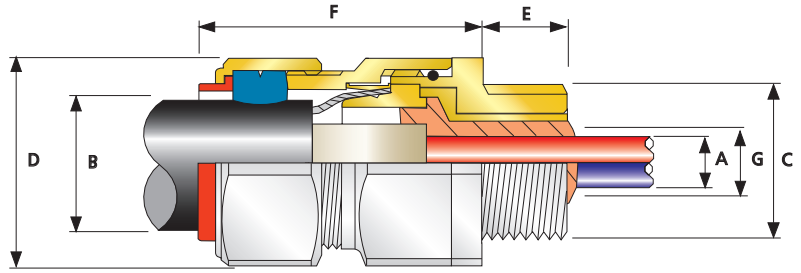

PX2KX/M



PX2KX/M Mining, Internationally Approved, Explosive Atmosphere Barrier Cable Gland

For Pliable Wire Armoured cables

- Metal-to-metal armour clamping
- Direct & remote installation
- Compound barrier type flameproof seal
- Controlled outer 'load retention' seal
- Unique OSTG prevents overtightening
- -60°C to +85°C
- Permitted in Zone 1
- Internationally marked, IECEx & ATEX
- Superior EMC performance



Also available with RapidEx

TECHNICAL DATA

Design Specification	BS 6121:Part 1:1989, IEC 62444, EN 62444
Mechanical Classifications*	Impact = Level 8, Cable Anchorage = Class D
Enclosure Protection	IK10 to IEC 62262 (20 joules) Brass & Stainless Steel only
Electrical Classifications*	Category B (Category A when used with braid, tape or pliable wire armour cables)
ATEX Certificate	SIRA13ATEX1072X
Code of Protection	⊕ IM2 Ex d I Mb, Ex e I Mb
Compliance Standards	EN 60079-0,1,7
IECEx Certificate	IECEx SIR 13.0027X
Code of Protection	Ex d I Mb, Ex e I Mb
Compliance Standards	IEC 60079-0,1,7
Ingress Protection Rating**	IP66, IP67 & IP68***
Deluge Protection Compliance	DTS01 : 91
Standard Cable Gland Material	Brass, Electroless Nickel Plated Brass, Stainless Steel
Seal Material	CMP SOLO LSF Halogen Free Thermoset Elastomer / Epoxy Barrier Compound
Cable Type	Pliable Wire Armour (PWA)
Armour Clamping	Detachable Compound Tube / Cone & AnyWay Universal Clamping Ring
Sealing Area(s)	Inner Compound Barrier & Cable Outer Sheath

* Mechanical & Electrical Classifications applied as per IEC 62444 & EN 62444

** When CMP installation accessories are used. Refer to page 7 or www.cmp-products.com for further information.

*** IP68 tested to a minimum depth of 30 metres for 12 hours, alternate depths / durations can be provided upon request

Cable Gland Selection Table

Refer to illustration at the top of the page.

Dimensions listed below are for metric cable glands only
Dimensions for alternative threads may vary, please see supplementary technical data sheet

Cable Gland Size	Available Entry Threads "C" (Alternate Metric Thread Lengths Available)					Maximum Number Of Cores	Maximum Diameter Over Conductors "A"	Cable Bedding Diameter "G"	Overall Cable Diameter "B"		Pliable Armour Wire		Across Flats "D"		Across Corners "D"	Protrusion Length "F"	Combined Ordering Reference (*Brass Metric)			Shroud	Cable Gland Weight (Kgs)
	Standard			Option					Min	Max	Min	Max	Max	Max			Size	Type	Ordering Suffix		
	Metric	Thread Length (Metric) "E"	NPT	Thread Length (NPT) "E"	NPT																
20S	M20	15.0	½"	19.9	¾"	11	11.7	11.7	9.5	15.9	0.0	7/0.45	30.5	33.6	62.0	20S	PX2KX	1RA/M	PVC06	0.230	
20	M20	15.0	½"	19.9	¾"	11	12.6	12.9	12.5	20.9	0.0	7/0.45	30.5	33.6	63.0	20	PX2KX	1RA/M	PVC06	0.240	
25S	M25	15.0	¾"	20.2	1"	21	17.5	17.9	14.0	22.0	0.0	7/0.45	37.5	41.3	69.5	25S	PX2KX	1RA/M	PVC09	0.370	
25	M25	15.0	¾"	20.2	1"	21	17.5	17.9	18.2	26.2	0.0	7/0.45	37.5	41.3	69.5	25	PX2KX	1RA/M	PVC09	0.370	
32	M32	15.0	1"	25.0	1 ¼"	38	23.6	23.9	23.7	33.9	0.0	7/0.45	46.0	50.6	75.0	32	PX2KX	1RA/M	PVC11	0.570	
40	M40	15.0	1 ¼"	25.6	1 ½"	59	30.0	30.3	27.9	40.4	0.0	7/0.71	55.0	60.5	75.0	40	PX2KX	1RA/M	PVC15	0.800	
50S	M50	15.0	1 ½"	26.1	2"	89	36.6	36.9	35.2	46.7	0.0	7/0.71	60.0	66.0	77.0	50S	PX2KX	1RA/M	PVC18	0.900	
50	M50	15.0	2"	26.9	2 ½"	89	41.0	41.3	40.4	53.0	0.0	7/0.71	70.1	77.1	77.0	50	PX2KX	1RA/M	PVC21	1.190	
63S	M63	15.0	2"	26.9	2 ½"	115	47.9	48.4	45.6	59.4	0.0	7/0.71	75.0	82.5	79.7	63S	PX2KX	1RA/M	PVC23	1.390	
63	M63	15.0	2 ½"	39.9	3"	115	53.7	54.0	54.6	65.8	0.0	7/0.71	80.0	88.0	80.3	63	PX2KX	1RA/M	PVC25	1.410	
75S	M75	15.0	2 ½"	39.9	3"	140	59.9	60.2	59.0	72.0	0.0	7/0.71	90.0	99.0	86.8	75S	PX2KX	1RA/M	PVC28	2.090	
75	M75	15.0	3"	41.5	3 ½"	140	64.2	64.2	66.7	78.4	0.0	7/0.71	100.0	110.0	88.3	75	PX2KX	1RA/M	PVC30	2.540	

*Note: For material options please add the following suffix to change the Ordering Reference ; Brass (no suffix required), Nickel Plated Brass "5", 316 Grade Stainless Steel "4", Copper Free Aluminium "1" For NPT options please add the following digits to the material suffix ; ½" = 31, ¾" = 32, 1" = 33, 1 ¼" = 34, 1 ½" = 35, 2" = 36, 2 ½" = 37, 3" = 38 (Brass requires prefix "0")

Examples: 32PX2KXM1RA534 = Nickel Plated Brass 1¼" NPT, 50SPX2KXM1RA035 = Brass 1½" NPT, 25PX2KXM1RA432 = Stainless Steel ¾" NPT, 20PX2KXM1RA5 = Nickel Plated Brass M20

Dimensions are displayed in millimetres unless otherwise stated

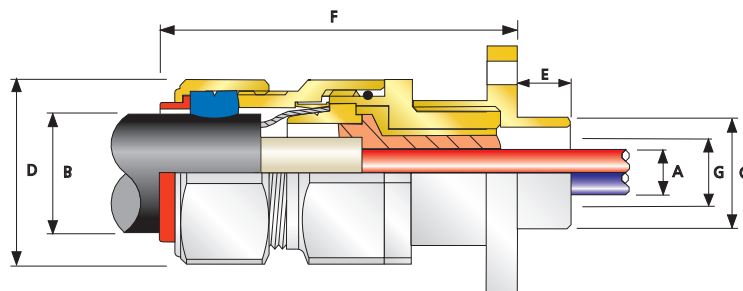

PX2KX/MF



PX2KX/MF Mining, Internationally Approved, Explosive Atmosphere Barrier Cable Gland

For Pliable Wire Armoured cables

- Complete with flanged adaptor
- Metal-to-metal armour clamping
- Direct & remote installation
- Compound barrier type flameproof seal
- Controlled outer 'load retention' seal
- Unique OSTG prevents overtightening
- -60°C to +85°C
- Permitted in Zone 1
- Internationally marked, IECEx & ATEX
- Superior EMC performance



See MAIFT, MAIB page for flange mounting dimensions

Alternative flange sizes available upon request

Also available with RapidEx

TECHNICAL DATA	
Design Specification	BS 6121:Part 1:1989, IEC 62444, EN 62444
Mechanical Classifications*	Impact = Level 8, Cable Anchorage = Class D
Enclosure Protection	IK10 to IEC 62262 (20 joules) Brass & Stainless Steel only
Electrical Classifications*	Category B
ATEX Certificate	SIRA13ATEX1072X, SIRA09ATEX1034U
Code of Protection	⊕ IM2 Ex d I Mb, Ex e I Mb
Compliance Standards	EN 60079-0,1,7
IECEx Certificate	IECEx SIR 13.0027X, IECEx SIR 09.0024U
Code of Protection	Ex d I Mb, Ex e I Mb
Compliance Standards	IEC 60079-0,1,7
Ingress Protection Rating**	IP66, IP67 & IP68***
Cable Gland Material	Brass, Electroless Nickel Plated Brass, Stainless Steel
Seal Material	CMP SOLO LSF Halogen Free Thermoset Elastomer / Epoxy Barrier Compound
Cable Type	Pliable Wire Armour (PWA)
Armour Clamping	Detachable Armour Cone & AnyWay Universal Clamping Ring
Sealing Technique	CMP 'LRS'™ Outer Load Retention Seal
Sealing Area(s)	Inner Compound Barrier & Outer Sheath

* Mechanical & Electrical Classifications applied as per IEC 62444 & EN 62444

** When CMP installation accessories are used. Refer to page 7 or www.cmp-products.com for further information.

*** IP68 tested to a minimum depth of 30 metres for 12 hours, alternate depths / durations can be provided upon request

Cable Gland Selection Table

Refer to illustration at the top of the page.

Dimensions listed below are for metric cable glands only
Dimensions for alternative threads may vary, please see supplementary technical data sheet

Cable Gland Size	Minimum Spigot Length "E"	Spigot Diameter "C"	Maximum Number Of Cores	Maximum Diameter Over Conductors "A"	Cable Bedding Diameter "G"	Overall Cable Diameter "B"		Pliable Armour Wire		Across Flats "D"	Across Corners "D"	Protrusion Length "F"	Combined Ordering Reference (*Brass Metric)			Cable Gland Weight (Kgs)
						Min	Max	Min	Max				Max	Max	Size	
20S	15.0	19.0	11	11.7	11.7	9.5	15.9	0.0	7/0.45	30.5	33.6	79.1	20S	PX2KX	1RA/MF	0.400
20	15.0	19.0	11	12.6	12.9	12.5	20.9	0.0	7/0.45	30.5	33.6	80.1	20	PX2KX	1RA/MF	0.390
25S	15.0	25.4	21	17.5	17.9	14.0	22.0	0.0	7/0.45	37.5	41.3	90.1	25S	PX2KX	1RA/MF	0.490
25	15.0	25.4	21	17.5	17.9	18.2	26.2	0.0	7/0.45	37.5	41.3	90.1	25	PX2KX	1RA/MF	0.620
32	15.0	31.8	38	23.6	23.9	23.7	33.9	0.0	7/0.45	46.0	50.6	96.2	32	PX2KX	1RA/MF	0.690
40	15.0	38.1	59	30.0	30.3	27.9	40.4	0.0	7/0.71	55.0	60.5	102.7	40	PX2KX	1RA/MF	0.960
50S	15.0	50.8	89	36.6	36.9	35.2	46.7	0.0	7/0.71	60.0	66.0	106.7	50S	PX2KX	1RA/MF	1.540
50	15.0	50.8	89	41.0	41.3	40.4	53.0	0.0	7/0.71	70.1	77.1	106.7	50	PX2KX	1RA/MF	1.640
63S	15.0	63.5	115	47.9	48.4	45.6	59.4	0.0	7/0.71	75.0	82.5	101.2	63S	PX2KX	1RA/MF	1.960
63	15.0	63.5	115	53.7	54.0	54.6	65.8	0.0	7/0.71	80.0	88.0	99.3	63	PX2KX	1RA/MF	2.200
75S	15.0	76.2	140	59.9	60.2	59.0	72.0	0.0	7/0.71	90.0	99.0	114.3	75S	PX2KX	1RA/MF	2.970
75	15.0	76.2	140	64.2	64.2	66.7	78.4	0.0	7/0.71	100.0	110.0	115.8	75	PX2KX	1RA/MF	3.650

*For material options add the following suffix to the Ordering Reference; Brass (no suffix required); Nickel Plated Brass 'S'; 316 Grade Stainless Steel '4'; Copper Free Aluminium '1'

Examples: 32PX2KXMF1RA = Brass, 50SPX2KXMF1RA5 = Nickel Plated Brass, 25PX2KXMF1RA4 = Stainless Steel

Dimensions are displayed in millimetres unless otherwise stated

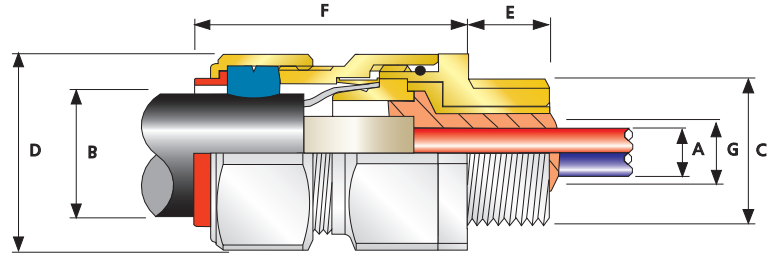

PX2KW/M



PX2KW/M Mining, Internationally Approved, Explosive Atmosphere Barrier Cable Gland

For all types Steel & Aluminium Wire Armoured cables

- Metal-to-metal armour clamping
- Direct & remote installation
- Compound barrier type flameproof seal
- Controlled outer 'load retention' seal
- Unique OSTG prevents overtightening
- -60°C to +85°C
- Permitted in Zone 1
- Internationally marked, IECEx & ATEX
- Superior EMC performance



Also available with RapidEx

TECHNICAL DATA

Design Specification	BS 6121:Part 1:1989, IEC 62444, EN 62444
Mechanical Classifications*	Impact = Level 8, Cable Anchorage = Class D
Enclosure Protection	IK10 to IEC 62262 (20 joules) Brass & Stainless Steel only
Electrical Classifications*	Category B
ATEX Certificate	SIRA13ATEX1072X
Code of Protection	Ⓜ IM2 Ex d I, Ex e I
Compliance Standards	EN 60079-0,1,7
IECEX Certificate	IECEX SIR 13.0027X
Code of Protection	Ex d I Mb, Ex e I Mb
Compliance Standards	IEC 60079-0,1,7
Ingress Protection Rating**	IP66, IP67 & IP68***
Deluge Protection Compliance	DTS01 : 91
Cable Gland Material	Brass, Electroless Nickel Plated Brass, Stainless Steel
Seal Material	CMP SOLO LSF Halogen Free Thermoset Elastomer / Epoxy Barrier Compound
Cable Type	Single Wire Armour (SWA), Aluminium Wire Armour (AWA)
Armour Clamping	Detachable Armour Cone & AnyWay Universal Clamping Ring
Sealing Technique	Unique CMP 'LRS' Outer Seal (Load Retention Seal)
Sealing Area(s)	Inner Compound Barrier & Outer Sheath

* Mechanical & Electrical Classifications applied as per IEC 62444 & EN 62444

** When CMP installation accessories are used. Refer to page 7 or www.cmp-products.com for further information.

*** IP68 tested to a minimum depth of 30 metres for 12 hours, alternate depths / durations can be provided upon request

Cable Gland Selection Table

Refer to illustration at the top of the page.

Dimensions listed below are for metric cable glands only
Dimensions for alternative threads may vary, please see supplementary technical data sheet

Cable Gland Size	Available Entry Threads "C" (Alternate Metric Thread Lengths Available)					Maximum Number Of Cores	Diameter Over Conductors "A"	Cable Bedding Diameter "G"	Overall Cable Diameter "B"		Armour Range		Across Flats "D"	Across Corners "D"	Protrusion Length "F"	Combined Ordering Reference (*Brass Metric)			Shroud	Cable Gland Weight (Kgs)
	Metric	Standard		Option					Min	Max	Min	Max				Size	Type	Ordering Suffix		
		Thread Length (Metric) "E"	NPT	Thread Length (NPT) "E"	NPT															
20S	M20	15.0	1/2"	19.9	3/4"	11	11.7	11.7	9.5	15.9	0.8	1.25	30.5	33.6	62.0	20S	PX2KW/M	1RA	PVC06	0.230
20	M20	15.0	1/2"	19.9	3/4"	11	12.6	12.9	12.5	20.9	0.8	1.25	30.5	33.6	63.0	20	PX2KW/M	1RA	PVC06	0.240
25S	M25	15.0	3/4"	20.2	1"	21	17.5	17.9	14.0	22.0	1.25	1.6	37.5	41.3	69.5	25S	PX2KW/M	1RA	PVC09	0.370
25	M25	15.0	3/4"	20.2	1"	21	17.5	17.9	18.2	26.2	1.25	1.6	37.5	41.3	69.5	25	PX2KW/M	1RA	PVC09	0.370
32	M32	15.0	1"	25.0	1 1/4"	38	23.6	23.9	23.7	33.9	1.6	2.0	46.0	50.6	75.0	32	PX2KW/M	1RA	PVC11	0.570
40	M40	15.0	1 1/4"	25.6	1 1/2"	59	30.0	30.3	27.9	40.4	1.6	2.0	55.0	60.5	75.0	40	PX2KW/M	1RA	PVC15	0.800
50S	M50	15.0	1 1/2"	26.1	2"	89	36.6	36.9	35.2	46.7	2.0	2.5	60.0	66.0	77.0	50S	PX2KW/M	1RA	PVC18	0.900
50	M50	15.0	2"	26.9	2 1/2"	89	41.0	41.3	40.4	53.0	2.0	2.5	70.1	77.1	77.0	50	PX2KW/M	1RA	PVC21	1.190
63S	M63	15.0	2"	26.9	2 1/2"	115	47.9	48.4	45.6	59.4	2.0	2.5	75.0	82.5	79.7	63S	PX2KW/M	1RA	PVC23	1.390
63	M63	15.0	2 1/2"	39.9	3"	115	53.7	54.0	54.6	65.8	2.0	2.5	80.0	88.0	80.3	63	PX2KW/M	1RA	PVC25	1.410
75S	M75	15.0	2 1/2"	39.9	3"	140	59.9	60.2	59.0	72.0	2.0	2.5	90.0	99.0	86.8	75S	PX2KW/M	1RA	PVC28	2.090
75	M75	15.0	3"	41.5	3 1/2"	140	64.2	64.2	66.7	78.4	2.5	3.0	100.0	110.0	88.3	75	PX2KW/M	1RA	PVC30	2.540

* For material options add the following suffix to the Ordering Reference, Brass (no suffix required), Nickel Plated Brass '5', 316 Grade Stainless Steel '4', Copper Free Aluminium '1'
For NPT options please add the following digits to the material suffix: 1/2" = 31, 3/4" = 32, 1" = 33, 1 1/4" = 34, 1 1/2" = 35, 2" = 36, 2 1/2" = 37, 3" = 38 (Brass requires prefix "0")

Examples: 32PX2KWM1RA534 = Nickel Plated Brass 1 1/4" NPT, 50SPX2KWM1RA035 = Brass 1 1/2" NPT, 25PX2KWM1RA432 = Stainless Steel 3/4" NPT, 20PX2KWM1RA5 = Nickel Plated Brass M20

Dimensions are displayed in millimetres unless otherwise stated

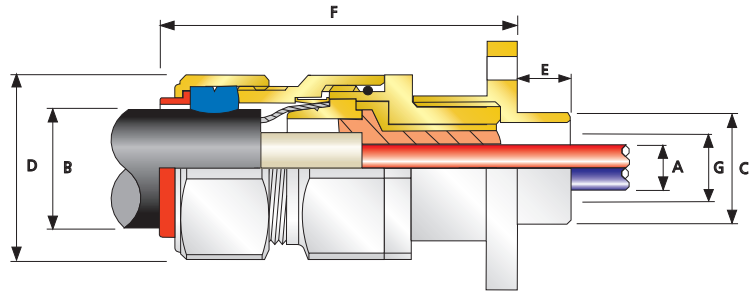

PX2KW/MF



PX2KW/MF Mining, Internationally Approved, Flanged Explosive Atmosphere Barrier Cable Gland

For all types Steel & Aluminium Wire Armoured cables

- Complete with flanged adaptor
- Metal-to-metal armour clamping
- Direct & remote installation
- Compound barrier type flameproof seal
- Controlled outer 'load retention' seal
- Unique OSTG prevents overtightening
- -60°C to +85°C
- Permitted in Zone 1
- Internationally marked, IECEx & ATEX
- Superior EMC performance



See MAIFT, MAIB page for flange mounting dimensions

Alternative flange sizes available upon request

Also available with RapidEx

TECHNICAL DATA

Design Specification	BS 6121:Part 1:1989, IEC 62444, EN 62444
Mechanical Classifications*	Impact = Level 8, Cable Anchorage = Class D
Enclosure Protection	IK10 to IEC 62262 (20 joules) Brass & Stainless Steel only
Electrical Classifications*	Category B
ATEX Certificate	SIRA13ATEX1072X, SIRA09ATEX1034U
Code of Protection	⊕ IM2 Ex d I Mb, Ex e I Mb
Compliance Standards	EN 60079-0,1,7
IECEx Certificate	IECEx SIR 13.0027X, IECEx SIR 09.0024U
Code of Protection	Ex d I Mb, Ex e I Mb
Compliance Standards	IEC 60079-0,1,7
Ingress Protection Rating**	IP66
Cable Gland Material	Brass, Electroless Nickel Plated Brass, Stainless Steel
Seal Material	CMP SOLO LSF Halogen Free Thermoset Elastomer / Epoxy Barrier Compound
Cable Type	Single Wire Armour (SWA), Aluminium Wire Armour (AWA)
Armour Clamping	Detachable Armour Cone & AnyWay Universal Clamping Ring
Sealing Technique	Unique CMP 'LRS' Outer Seal (Load Retention Seal)
Sealing Area(s)	Inner Compound Barrier & Outer Sheath

* Mechanical & Electrical Classifications applied as per IEC 62444 & EN 62444

** When CMP installation accessories are used. Refer to page 7 or www.cmp-products.com for further information.

Cable Gland Selection Table

Refer to illustration at the top of the page.

Cable Gland Size	Minimum Spigot Length "E"	Spigot Diameter "C"	Maximum Number Of Cores	Diameter Over Conductors "A"	Cable Bedding Diameter "G"	Overall Cable Diameter "B"		Armour Range		Across Flats "D"	Across Corners "D"	Protrusion Length "F"	Combined Ordering Reference (*Brass Metric)			Cable Gland Weight (Kgs)
						Min	Max	Min	Max				Max	Max	Size	
20S	15.0	19.0	11	11.7	11.7	9.5	15.9	0.8	1.25	30.5	33.6	79.1	20S	PX2KW	1RA/MF	0.390
20	15.0	19.0	11	12.6	12.9	12.5	20.9	0.8	1.25	30.5	33.6	80.1	20	PX2KW	1RA/MF	0.400
25S	15.0	25.4	21	17.5	17.9	14.0	22.0	1.25	1.6	37.5	41.3	90.1	25S	PX2KW	1RA/MF	0.620
25	15.0	25.4	21	17.5	17.9	18.2	26.2	1.25	1.6	37.5	41.3	90.1	25	PX2KW	1RA/MF	0.620
32	15.0	31.8	38	23.6	23.9	23.7	33.9	1.6	2.0	46.0	50.6	96.2	32	PX2KW	1RA/MF	0.890
40	15.0	38.1	59	30.0	30.3	27.9	40.4	1.6	2.0	55.0	60.5	102.7	40	PX2KW	1RA/MF	1.190
50S	15.0	50.8	89	36.6	36.9	35.2	46.7	2.0	2.5	60.0	66.0	106.7	50S	PX2KW	1RA/MF	1.640
50	15.0	50.8	89	41.0	41.3	40.4	53.0	2.0	2.5	70.1	77.1	106.7	50	PX2KW	1RA/MF	1.930
63S	15.0	63.5	115	47.9	48.4	45.6	59.4	2.0	2.5	75.0	82.5	101.2	63S	PX2KW	1RA/MF	2.160
63	15.0	63.5	115	53.7	54.0	54.6	65.8	2.0	2.5	80.0	88.0	99.3	63	PX2KW	1RA/MF	2.220
75S	15.0	76.2	140	59.9	60.2	59.0	72.0	2.0	2.5	90.0	99.0	114.3	75S	PX2KW	1RA/MF	3.650
75	15.0	76.2	140	64.2	64.2	66.7	78.4	2.5	3.0	99.0	100.0	115.8	75	PX2KW	1RA/MF	4.100

*For material options add the following suffix to the Ordering Reference; Brass (no suffix required); Nickel Plated Brass '5'; 316 Grade Stainless Steel '4'; Copper Free Aluminium '1'

Examples: 32PX2KWMF1RA = Brass, 50SPX2KWMF1RA5 = Nickel Plated Brass, 25PX2KWMF1RA4 = Stainless Steel

Dimensions are displayed in millimetres unless otherwise stated





Americas Hazardous Location Cable Glands

The CMP range of Cable Glands for Hazardous (Classified) Locations and Ordinary Locations are versatile enough to meet virtually all applications where flexible and non flexible cables are used.

Designed for both offshore and onshore requirements, the options cover all types of Non Armoured flexible cables, cords and tray cables, including TC-ER-HL and Type P and all armoured cables types, including; MC, MC-HL, Interlocked, Teck, Braid armoured shipboard and served wire armour

CMP's Hazardous (Classified) Locations cable glands comply with the prevailing UL, ISA, ANSI, CSA & IEC standards and meet the requirements of the NEC, CEC & IEC installation code requirements to provide complete global solutions.

All Cable Glands shown in Nickel Plated Brass, alternative materials are available.



TMC2X Cable Glands - The Key Features

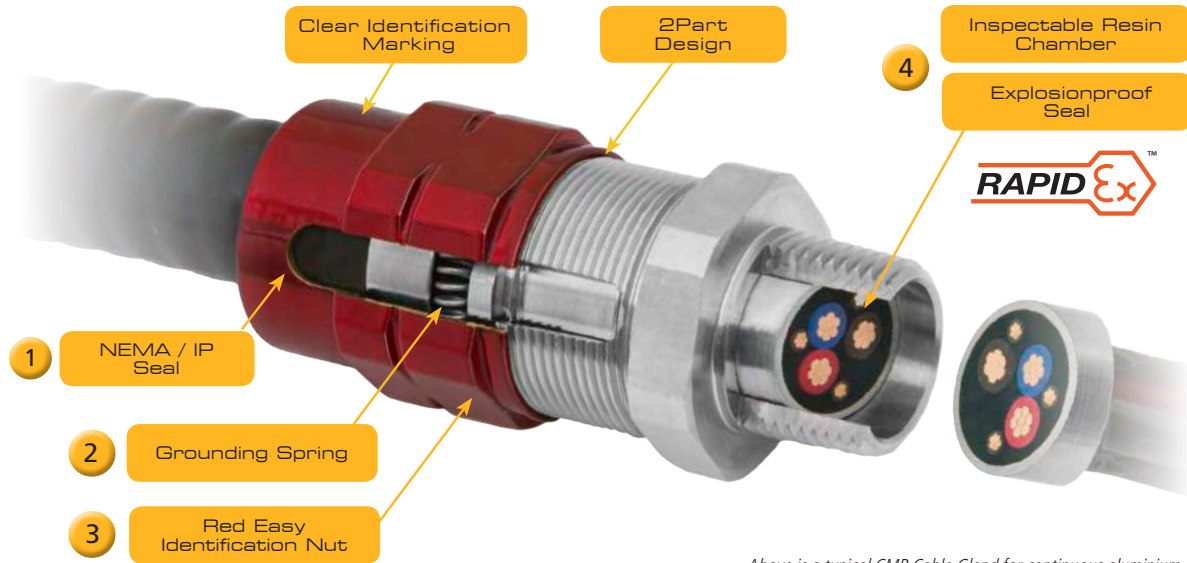

Above is a typical CMP Cable Gland for continuous aluminium (MC-HL), Teck 90, interlocked aluminium and interlocked steel cables

1 NEMA / IP Environmental Seal

The TMC2X incorporates a 'weak back' seal which is designed to prevent the ingress of dust and rain, splashing water, hose-directed water and damage from exterior ice formation. The seal enables the gland to meet the requirements of NEMA 4X and IP66. The seal provides a wide cable acceptance range allowing cables from 0.5" to 4.25" to be incorporated in only 12 trade sizes of connector. The seal is manufactured from low smoke, flame resistant, halogen-free elastomer which meets the requirements of EN50267-21 and LUL Fire Safety Regulations.

2 Armor Termination

The TMC2X has been designed and tested to terminate all types of metal clad cables including continuous aluminium (MC-HL), Teck 90, interlocked aluminium and interlocked steel. An internal corrosion resistant stainless steel spring provides 360° grounding of the armor and allows for easy installation and disconnection of the cable where required. The spring provides excellent pull-out resistance which exceeds the requirements of CSA C22.2 & UL514B. The spring is non-magnetic and is suitable for use with single conductor power cables carrying in excess of 200A.

3 Easy Identification Nut

Outer seal nuts provided by CMP have large wrench holds for ease of installation and display clear laser marking showing the Cable Gland properties, certification and hazardous location details.

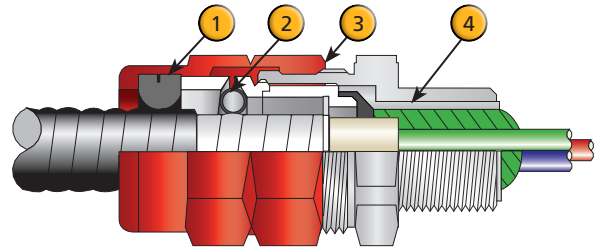

4 Inspectable RapidEx Resin Chamber

A barrier type cable gland which is disconnectable utilizing a tried and tested metal barrier tube which provides an Explosionproof joint that enables cables to be safely and easily removed from equipment. The Explosionproof joint path can be visually inspected and also measured according to the parameters of IECEx and cCSAus for flame paths.

Explosionproof Seal

The TMC2X incorporates the RapidEx liquid pour, fast curing, liquid resin seal that installs in seconds and cures in minutes. Its unique formula begins with a low viscosity liquid that flows into the cable interstices completely surrounding the cable conductors, driving out all the air in the process. The viscosity then increases and completely cures in minutes. Once cured the RapidEx resin adheres to both the cable conductors and the inside of the barrier tube creating a bond that will last for the life of the cable connector. The RapidEx seal will never crack or shrink with changes in temperature.



How to Order - TMC2X, TMC2 & TC

Example Ordering

TC-
100
A
079
No further reference required

Type 1" Aluminum 1.18"

TMC2X-
050
NB
099
X
No further reference required

Type ½" Nickel Plated Finish 0.99" Suffix I.D.

TMC2
075
SS
075
No further reference required

Type ¾" Stainless Steel 0.75"

Cable Gland Type	Thread Order Reference*	Material	Max Cable Jacket Diameter (TMC2, TMC2X)	Max Cable Diameter (TC)	Supply Type
TMC2X	- 050 ½"	A Aluminum	075 0.75"	028 0.28"	X with RapidEx** (TMC2X only)
TMC2	075 ¾"	SS Stainless Steel	099 0.99"	055 0.55"	
TC	100 1"	NB Nickel Plated Brass	118 1.18"	079 0.79"	
	125 1 ¼"		137 1.37"	104 1.04"	
	150 1 ½"		162 1.62"	127 1.27"	
	200 2"		190 1.90"	150 1.50"	
	250 2 ½"		200 2.00"	174 1.74"	
	300 3"		233 2.33"	197 1.97"	
	350 3 ½"		272 2.72"	220 2.20"	
	400 4"		325 3.25"	244 2.44"	
			376 3.76"	268 2.68"	
			425 4.25"	315 3.15"	
				354 3.54"	

* Other thread types and sizes available upon request.
 ** Supplied in pack with RapidEx resin

CMP PRODUCTS HAZARDOUS LOCATION CABLE GLANDS

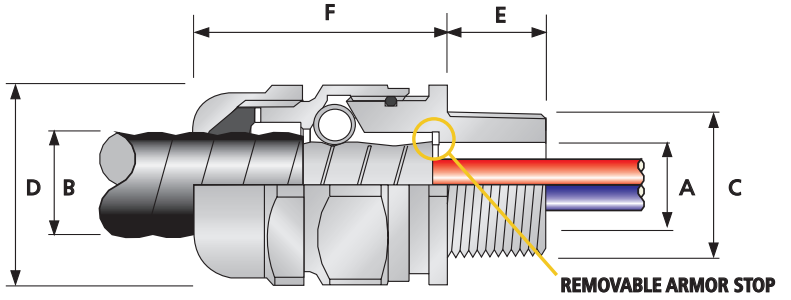

TMC Globally Approved, Hazardous (Classified) Location Cable Gland

For MC, MC-HL, Interlocked & Teck Armored Cables

- Simple, sequential installation process
- No disassembly required
- Integral protected deluge seal
- 360° grounding spring (non-magnetic)
- -76°F to 230°F
- Globally marked, UL, cCSAus, IECEx & ATEX
- Interface 'O' ring seal supplied with Aluminum
- SOLO LSF Halogen Free Shrouds also available on request

Please note the following installation requirements:
 1) Where Explosionproof enclosures are being used the TMC must be installed with an approved pouring or compound sealing fitting. In Division 2 locations the TMC can be fitted directly to an enclosure which has no source of ignition in accordance with NEC/CEC requirements.
 2) Glands with NPT entry threads are suitable for both Divisions and Zones.
 3) Glands with Metric entry threads are suitable for Zones only unless fitted with an approved NPT male adaptor in accordance with CEC requirements.



TECHNICAL DATA	
Design Specification	BS 6121:Part 1:1989, IEC 62444, EN 62444
Mechanical Classifications*	Impact = Level 8, Cable Anchorage = Class D
Enclosure Protection	IK10 to IEC 62262 (20 joules) Brass & Stainless Steel only
ATEX Certificate	SIRA07ATEX1122X
Code of Protection	⊕ II 2GD, Ex e II, Ex tD A21 IP66
Compliance Standards	EN 60079-0,7, EN 612410,1
IECEx Certificate	IECEx SIR 07.0083X
Code of Protection	Ex e II, Ex tD A21 IP66
Compliance Standards	IEC 60079-0,1,7,31
cCSAus Certificate	1129339
CSAus Code of Protection	Class II, Div 1 and 2, Groups E, F, and G; Class III, Div 1 and 2; Encl. Type 3, 4, 4X. Class I, Zone 1, AEx e II;
cCSA Code of Protection	Class II, Div 1 and 2, Groups E, F, and G; Class III, Div 1 and 2; Encl. Type 3, 4, 4X. Ex e II;
Compliance Standards	CAN/CSA-C22.2 Various Sections (See Certificate) CAN/CSA-E60079-0, IEC 60079-0,1
UL Certificate	E256366
Code of Protection	Class I, Zone 1, AEx e II
Compliance Standards	UL 514B, UL 60079-0,7, U 2225
EAC Certificate	TC RU C-GB.ГБ05.В00138
CCOE / PESO (India) Certificate	P333688
Marine Approvals	LRS: 01/00172 (E3) DNV: E-13848 ABS: 14-LD234401A-4-PDA
Ingress Protection Rating**	NEMA 4X & IP66
Cable Gland Material	Copper Free Aluminum (<0.4%), Electroless Nickel Plated Brass, Stainless Steel
Seal Material	CMP SOLO LSF Halogen Free Thermoset Elastomer
Cable Type	Corrugated & Interlocked Metal Clad Armor (MC) or TECK90, Continuously Welded Metal Clad Armor (MCHL), ACIC-HL, ACWU90-HL, RC90-HL, RA90-HL
Armor Clamping	360° Stainless Steel Grounding Spring (non-magnetic)
Sealing Technique	CMP Load Retention Seal
Sealing Area(s)	Cable Outer Jacket

* Mechanical & Electrical Classifications applied as per IEC 62444 & EN 62444
 ** When CMP installation accessories are used. Refer to page 7 or www.cmp-products.com for further information.

Cable Gland Selection Table

Refer to illustration at the top of the page

Order Reference (NPT)			Entry Thread "C"		Minimum Thread Length "E"	Minimum Thread Length "E"	Cable Armor Diameter "A"				Cable Jacket Diameter "B"		Nominal Assembly Length "F"	Max		Shroud	Weight (Ozs)
Aluminum	Nickel Plated Brass	Stainless Steel	NPT	Metric	NPT	Metric	End Stop In		End Stop Out		Min	Max		Across Flats "D"	Across Corners "D"		
							Min	Max	Min	Max							
TMC050SA	TMC050SNB	TMC050SSS	½"	M20	0.78	0.59	No Stop	No Stop	0.34	0.50	0.35	0.55	1.83	1.20	1.32	PVC06	7.90
TMC050A	TMC050NB	TMC050SS	½"	M20	0.78	0.59	No Stop	No Stop	0.51	0.67	0.44	0.79	2.06	1.42	1.56	PVC09	9.91
TMC075A	TMC075NB	TMC075SS	¾"	M25	0.80	0.59	0.59	0.76	0.76	0.92	0.67	1.04	2.09	1.61	1.78	PVC10	11.61
TMC100A	TMC100NB	TMC100SS	1"	M32	0.98	0.59	0.78	0.97	0.97	1.15	0.87	1.27	2.24	1.97	2.17	PVC13	17.53
TMC125A	TMC125NB	TMC125SS	1 ½"	M40	1.01	0.59	1.08	1.23	1.23	1.39	1.16	1.50	2.22	2.17	2.38	PVC15	20.92
TMC150A	TMC150NB	TMC150SS	1 ½"	M50	1.03	0.59	1.32	1.46	1.46	1.62	1.40	1.74	2.31	2.36	2.60	PVC18	24.45
TMC200SA	TMC200SNB	TMC200SSS	2"	M50	1.06	0.59	1.51	1.68	1.68	1.85	1.58	1.97	2.52	2.76	3.03	PVC21	42.33
TMC200A	TMC200NB	TMC200SS	2"	M63	1.06	0.59	1.77	1.93	1.93	2.09	1.86	2.21	2.49	2.95	3.25	PVC23	38.80
TMC250SA	TMC250SNB	TMC250SSS	2 ½"	M75	1.57	0.59	2.05	2.16	2.16	2.32	2.08	2.44	2.73	3.15	3.47	PVC25	59.97
TMC250A	TMC250NB	TMC250SS	2 ½"	M75	1.57	0.59	2.25	2.41	2.41	2.55	2.33	2.68	2.84	3.35	3.68	PVC27	56.48
TMC300A	TMC300NB	TMC300SS	3"	M90	1.63	0.59	2.54	2.78	2.78	2.97	2.62	3.13	3.87	4.33	4.76	LSF32	123.46
TMC350A	TMC350NB	TMC350SS	3 ½"	M100	1.69	0.95	2.91	3.29	3.29	3.49	2.99	3.83	4.63	5.25	5.78	LSF34	236.34
TMC400A	TMC400NB	TMC400SS	4"	M115	1.73	0.95	2.91	3.29	3.29	3.49	2.99	3.83	4.63	5.25	5.78	LSF34	264.55

Order Code Example: TMC250SS "TMC" (Gland Type) - "250" (2 ½" NPT Thread) - "SS" (Material Stainless Steel)

Dimensions are displayed in inches unless otherwise stated

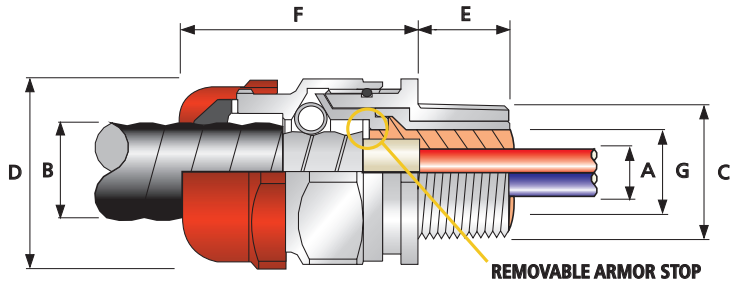

TMCX



TMCX Globally Approved, Hazardous (Classified) Location Barrier Cable Gland

For MC, MC-HL, Interlocked & Teck Armored Cables

- Simple, sequential installation process
- Compound barrier type flameproof seal
- Integral protected deluge seal
- 360° grounding spring (non-magnetic)
- Disconnectable, union design feature
- -76°F to 185°F / -60°C to 85°C
- Globally marked, UL, cCSAus, IECEx & ATEX



TECHNICAL DATA	
Design Specification	BS 6121:Part 1:1989, IEC 62444, EN 62444
Mechanical Classification	Impact = Level 8, Cable Anchorage = Class D
Enclosure Protection	IK10 to IEC 62262 (20 joules) Brass & Stainless Steel only
ATEX Certificate	SIRA07ATEX1122X
Code of Protection	Ⓔ II 2GD, Ex d IIC, Ex e IIC, Ex tD A21 IP66
Compliance Standards	EN 60079-0,7, EN 612410,1
IECEx Certificate	IECEx SIR 07.0083X
Code of Protection	Ex d IIC, Ex e II, Ex tD A21 IP66
Compliance Standards	IEC 60079-0,1,7,31
cCSAus Certificate	1129339
CSAus Code of Protection	Class I, Div 1 and 2, Groups A, B, C and D; Class II, Div 1 and 2, Groups E, F, and G; Class III, Div 1 and 2; Encl. Type 3, 4, 4X. Class I, Zone 1, AEx d IIC; AEx e II
cCSA Code of Protection	Class I, Div 1 and 2, Groups A, B, C and D; Class II, Div 1 and 2, Groups E, F, and G; Class III, Div 1 and 2; Encl. Type 3, 4, 4X. Ex d IIC; Ex e II
Compliance Standards	CAN/CSA-C22.2 Various Sections (See Certificate) CAN/CSA-E60079-0, CAN/CSA-E60079-1
UL Certificate	E256366
Code of Protection	Class I, Div 2, Groups A,B,C,D, Class II, Div 2, Groups F,G Class I, Zone 1, AEx d IIC, AEx e II
EAC Certificate	TC RU C-GB.F605.B00138
CCOE / PESO (India) Certificate	P333688
RETIE Approval Number	03866
Marine Approvals	LRS: 01/00172 (E3) DNV: E-13848 ABS: 14-LD234401A-4-PDA
Ingress Protection Rating**	NEMA 4X & IP66
Cable Type	Corrugated & Interlocked Metal Clad Armor (MC) or TECK90, Continuously Welded Metal Clad Armor (MCHL), ACIC-HL, ACWU90-HL, RC90-HL, RA90-HL
Armor Clamping	360° Stainless Steel Grounding Spring (non-magnetic)
Jacket Sealing Technique	CMP Unique Displacement Seal Concept
Sealing Area(s)	Inner Compound Barrier and Cable Outer Jacket
Seal Material	CMP SOLO LSF Halogen Free Thermoset Elastomer / Epoxy Barrier Compound
Cable Gland Material	Copper Free (<0.4%) Aluminum, Stainless Steel, Electroless Nickel Plated Brass

Cable Gland Selection Table

Refer to illustration at the top of the page

* Mechanical & Electrical Classifications applied as per IEC 62444 & EN 62444

** When CMP installation accessories are used. Refer to page 7 or www.cmp-products.com for further information.

Order Reference (NPT)			Entry Thread "C"	Entry Thread "C"	Minimum Thread Length "E"	Minimum Thread Length "E"	Cable Armor Diameter "A"				Cable Jacket Diameter "B"		Nominal Assembly Length "F"	Max		Shroud	Weight (Ozs)
Aluminum	Nickel Plated Brass	Stainless Steel					NPT	Metric	NPT	Metric	Armor Stop in			Armor Stop Out			
			Min	Max	Min	Max											
TMCX050SA	TMCX050SNB	TMCX050SSS	1/2"	M20	0.78	0.59	No Stop	No Stop	0.34	0.50	0.35	0.55	1.83	1.20	1.32	PVC06	7.90
TMCX050A	TMCX050NB	TMCX050SS	1/2"	M20	0.78	0.59	No Stop	No Stop	0.51	0.67	0.44	0.79	2.06	1.42	1.56	PVC09	9.91
TMCX075A	TMCX075NB	TMCX075SS	3/4"	M25	0.80	0.59	0.59	0.76	0.76	0.92	0.67	1.04	2.09	1.61	1.78	PVC10	11.61
TMCX100A	TMCX100NB	TMCX100SS	1"	M32	0.98	0.59	0.78	0.97	0.97	1.15	0.87	1.27	2.24	1.97	2.17	PVC13	17.53
TMCX125A	TMCX125NB	TMCX125SS	1 1/4"	M40	1.01	0.59	1.08	1.23	1.23	1.39	1.16	1.50	2.22	2.17	2.38	PVC15	20.92
TMCX150A	TMCX150NB	TMCX150SS	1 1/2"	M50	1.03	0.59	1.32	1.46	1.46	1.62	1.40	1.74	2.31	2.36	2.60	PVC18	24.45
TMCX200SA	TMCX200SNB	TMCX200SSS	2"	M50	1.06	0.59	1.51	1.68	1.68	1.85	1.58	1.97	2.52	2.76	3.03	PVC21	42.33
TMCX200A	TMCX200NB	TMCX200SS	2"	M63	1.06	0.59	1.77	1.93	1.93	2.09	1.86	2.21	2.49	2.95	3.25	PVC23	38.80
TMCX250SA	TMCX250SNB	TMCX250SSS	2 1/2"	M75	1.57	0.59	2.05	2.16	2.16	2.32	2.08	2.44	2.73	3.15	3.47	PVC25	59.97
TMCX250A	TMCX250NB	TMCX250SS	2 1/2"	M75	1.57	0.59	2.25	2.41	2.41	2.55	2.33	2.68	2.84	3.35	3.68	PVC27	56.48
TMCX300A	TMCX300NB	TMCX300SS	3"	M90	1.63	0.95	2.54	2.78	2.78	2.97	2.62	3.13	3.87	4.33	4.76	LSF32	123.46
TMCX350A	TMCX350NB	TMCX350SS	3 1/2"	M100	1.69	0.95	2.91	3.29	3.29	3.49	2.99	3.83	4.52	5.25	5.78	LSF34	236.34
TMCX400A	TMCX400NB	TMCX400SS	4"	M115	1.73	0.95	2.91	3.29	3.29	3.49	2.99	3.83	4.52	5.25	5.78	LSF34	264.55

Order Code Example: TMCX250SS "TMC" (Gland Type) - "250" (2 1/2" NPT Thread) - "SS" (Material Stainless Steel)

Dimensions are displayed in inches unless otherwise stated

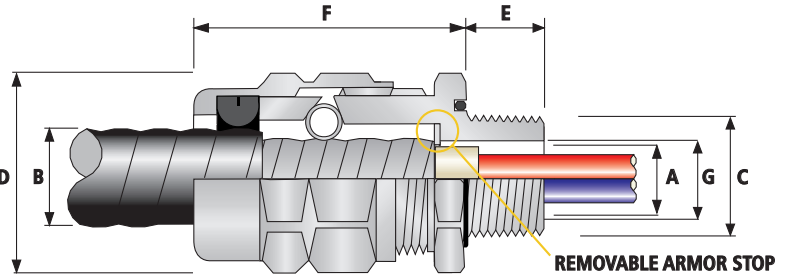

TMC2 Aluminum Globally Approved, Hazardous (Classified) Location Cable Gland

For MC, MC-HL, Interlocked & Teck Armored Cables

- Simplified two part design
- Compact slim profile
- Independent sealing & armor clamping
- Simple, sequential installation process
- No disassembly required
- Equipment interface 'O' ring seal as standard
- Hub not required
- 360° grounding spring (non-magnetic)
- -76°F to 230°F
- Globally marked, cCSAus, IECEx & ATEX



TECHNICAL DATA	
Design Specification	BS 6121:Part 1:1989, IEC 62444, EN 62444
Enclosure Protection	IK10 to IEC 62262 (20 joules) Brass & Stainless Steel only
Mechanical Classifications*	Impact = Level 8, Cable Anchorage = Class D
ATEX Certificate	SIRA09ATEX1164X
Code of Protection	⊕ II 2GD, Ex e IIC Gb, Ex ta IIIC Da
Compliance Standards	EN 60079-0,7, EN 612410,1
IECEx Certificate	IECEx SIR 09.0068X
Code of Protection	Ex e IIC Gb, Ex ta IIIC Da
Compliance Standards	IEC 60079-0,1,7,31
cCSAus Certificate	2194053
CSAus Code of Protection	Class I, Div 2, Groups A, B, C and D; Class II, Div 1 and 2, Groups E, F, and G; Class III, Div 1 and 2; Encl. Type 4X. Class I, Zone 1, AEx e II; AEx ta IIC:
cCSA Code of Protection	Class I, Div 2, Groups A, B, C and D; Class II, Div 1 and 2, Groups E, F, and G; Class III, Div 1 and 2; Encl. Type 4X. Ex e II;
Compliance Standards	CAN/CSA-C22.2 Various Sections (See Certificate) CAN/CSA-E60079-0,7, CAN/CSA-E6124111, ANSI/UL 514B Ed 5, ANSI/UL 50 Ed 11
EAC Certificate	TC RU C-GB.F605.B00138
CCOE / PESO (India) Certificate	P333688
RETIE Approval Number	03866
Marine Approvals	LRS: 01/00172 (E3) DNV: E-13848 ABS: 15-LD1410479-PDA
Ingress Protection Rating**	NEMA 4X & IP66
Cable Type	Corrugated & Interlocked Metal Clad Armor (MC) or TECK90, Continuously Welded Metal Clad Armor (MCHL), ACIC-HL, ACWU90-HL, RC90-HL, RA90-HL
Armor Clamping	360° Stainless Steel Grounding Spring (non-magnetic)
Jacket Sealing Technique	CMP Load Retention Seal
Sealing Area(s)	Cable Outer Jacket
Seal Material	CMP SOLO LSF Halogen Free Thermoset Elastomer
Cable Gland Material	Copper Free (<0.4%) Aluminum, Stainless Steel, Electroless Nickel Plated Brass

Cable Gland Selection Table
Refer to illustration at the top of the page

* Mechanical & Electrical Classifications applied as per IEC 62444 & EN 62444
** When CMP installation accessories are used. Refer to page 7 or www.cmp-products.com for further information.

Order Reference (NPT suffix required)			Entry Thread "C"		Minimum Thread Length "E"	Cable Armor Diameter "A"				Cable Jacket Diameter "B"		Thru Bore "G"	Across Flats "D"	Across Corners "D"	Nominal Assembly Length "F"	Shroud	Approx Weight Aluminum (Ozs)
Aluminum	Nickel Plated Brass	Stainless Steel	NPT Standard	NPT Option		Armor Stop In		Armor Stop Out		Min	Max						
						Min	Max	Min	Max								
TMC2050A075	TMC2050NB075	TMC2050SS075	1/2"	-	0.78	0.42	0.55	0.55	0.63	0.50	0.75	0.51	1.20	1.32	2.44	PVC06	2.29
TMC2075A075	TMC2075NB075	TMC2075SS075	-	3/4"	0.80	0.42	0.55	0.55	0.63	0.69	0.99	0.61	1.48	1.63	2.96	PVC09	3.00
TMC2050A099	TMC2050NB099	TMC2050SS099	1/2"	-	0.78	0.60	0.65	0.65	0.89	0.69	0.99	0.75	1.48	1.63	2.96	PVC09	3.00
TMC2075A099	TMC2075NB099	TMC2075SS099	-	3/4"	0.80	0.60	0.78	0.78	0.89	0.87	1.18	0.82	1.81	1.99	3.15	PVC11	5.11
TMC2075A118	TMC2075NB118	TMC2075SS118	3/4"	-	0.80	0.79	0.86	0.86	1.10	0.87	1.18	0.95	1.81	1.99	3.15	PVC11	5.11
TMC2100A118	TMC2100NB118	TMC2100SS118	-	1"	0.98	0.79	0.98	0.98	1.10	1.02	1.37	1.04	2.05	2.26	3.55	PVC15	6.70
TMC2100A137	TMC2100NB137	TMC2100SS137	1"	-	0.98	0.94	1.08	1.08	1.28	1.30	1.62	1.31	2.36	2.60	3.59	PVC18	8.82
TMC2125A137	TMC2125NB137	TMC2125SS137	-	1 1/4"	1.01	0.94	1.18	1.18	1.28	1.30	1.62	1.38	2.36	2.60	3.59	PVC18	8.82
TMC2125A162	TMC2125NB162	TMC2125SS162	1 1/4"	-	1.01	1.22	1.35	1.35	1.50	1.57	1.90	1.37	2.56	2.82	3.59	PVC37	9.45
TMC2150A162	TMC2150NB162	TMC2150SS162	-	1 1/2"	1.03	1.22	1.42	1.42	1.50	1.30	1.62	1.54	2.56	2.82	3.59	PVC37	9.45
TMC2125A190	TMC2125NB190	TMC2125SS190	1 1/4"	-	1.01	-	-	1.51	1.72	1.57	1.90	1.37	2.56	2.82	3.59	PVC37	9.45
TMC2150A190	TMC2150NB190	TMC2150SS190	-	1 1/2"	1.03	-	-	1.51	1.72	1.57	1.90	1.54	2.56	2.82	3.59	PVC37	9.45
TMC2150A200	TMC2150NB200	TMC2150SS200	1 1/2"	-	1.03	1.57	1.70	1.70	1.88	1.65	2.00	1.61	2.75	3.03	3.76	PVC21	11.06
TMC2200A200	TMC2200NB200	TMC2200SS200	-	2"	1.06	1.57	1.70	1.70	1.88	1.65	2.00	1.65	2.75	3.03	3.76	PVC21	11.06
TMC2150A233	TMC2150NB233	TMC2150SS233	-	1 1/2"	1.03	-	-	1.81	2.21	1.90	2.33	1.61	2.95	3.25	3.97	PVC23	12.77
TMC2200A233	TMC2200NB233	TMC2200SS233	2"	-	1.06	-	-	1.81	2.21	1.90	2.33	2.03	2.95	3.25	3.97	PVC23	12.77
TMC2250A233	TMC2250NB233	TMC2250SS233	-	2 1/2"	1.57	-	-	1.81	2.21	1.90	2.33	2.03	2.95	3.25	3.97	PVC23	12.77
TMC2200A272	TMC2200NB272	TMC2200SS272	-	2"	1.06	2.14	2.46	2.17	2.61	2.27	2.72	2.07	3.54	3.89	4.10	PVC28	24.69
TMC2250A272	TMC2250NB272	TMC2250SS272	2 1/2"	-	1.57	2.14	2.46	2.46	2.61	2.27	2.72	2.40	3.54	3.89	4.10	PVC28	24.69
TMC2300A272	TMC2300NB272	TMC2300SS272	-	3"	1.63	2.14	2.46	2.46	2.61	2.27	2.72	2.40	3.54	3.89	4.10	PVC28	24.69
TMC2300A325	TMC2300NB325	TMC2300SS325	3"	-	1.63	2.49	2.78	2.78	2.97	2.62	3.25	2.72	4.33	4.76	4.67	PVC32	42.68
TMC2350A325	TMC2350NB325	TMC2350SS325	-	3 1/2"	1.69	2.49	2.78	2.78	2.97	2.62	3.25	2.72	4.33	4.76	4.67	PVC32	42.68
TMC2350A376	TMC2350NB376	TMC2350SS376	3 1/2"	-	1.69	2.95	3.45	3.45	3.54	3.16	3.76	3.38	4.84	5.32	4.95	LSF33	53.44
TMC2400A376	TMC2400NB376	TMC2400SS376	-	4"	1.73	2.95	3.45	3.45	3.54	3.16	3.76	3.38	4.84	5.32	4.95	LSF33	53.44
TMC2400A425	TMC2400NB425	TMC2400SS425	4"	-	1.73	-	-	3.56	3.94	3.70	4.25	3.59	5.23	5.75	5.16	LSF34	59.19

Order Code Example: TMC2050A075 - "TMC2" (Type Gland) - "050" (1/2" NPT Thread) - "A" (Material Aluminum) - "075" (Max Cable Diameter 0.75")
Dimensions are displayed in inches unless otherwise stated

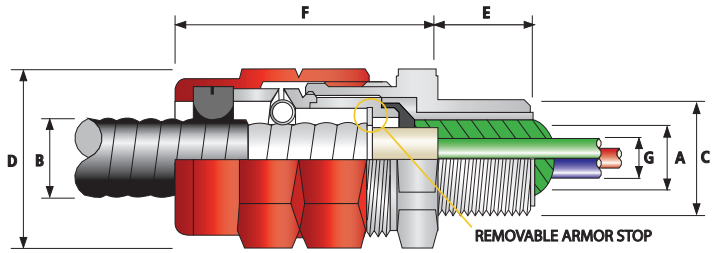

TMC2X Ex e Ex d Ex ta

TMC2X Globally Approved, Hazardous (Classified) Location Barrier Cable Gland

For MC, MC-HL, Interlocked & Teck Armored Cables

- RapidEx liquid pour sealing system
 - Enhances reliability, reduces risk
 - Reduces man hours
 - Reduces cost
- Simplified two part design
- Compact slim profile
- Independent sealing & armor clamping
- Simple, sequential installation process
- 360° grounding spring (non-magnetic)
- Disconnectable, union design feature
- -76°F to 185°F / -60°C to 85°C
- Globally marked, cCSAus, IECEx & ATEX

Supplied in pack with RapidEx resin



TECHNICAL DATA	
Design Specification	BS 6121:Part 1:1989, IEC 62444, EN 62444
Mechanical Classification	Impact = Level 8, Cable Anchorage = Class D
Enclosure Protection	IK10 to IEC 62262 (20 joules) Brass & Stainless Steel only
ATEX Certificate	SIRA09ATEX1165X
Code of Protection	Ex II ZG 1D, Ex d IIC, Ex e IIC Gb, Ex ta IIIC Da
Compliance Standards	EN 60079-0,7, EN 612410,1
IECEX Certificate	IECEX SIR 09.0069X
Code of Protection	Ex d IIC Gb, Ex e IIC Gb, Ex ta IIIC Da
Compliance Standards	IEC 60079-0,1,7,31
cCSAus Certificate	2194053
CSAus Code of Protection	Class I, Div 1 and 2, Groups A, B, C and D; Class II, Div 1 and 2, Groups E, F, and G; Class III, Div 1 and 2; End. Type 4X. Class I, Zone 1, AEx d IIC; AEx e II; AEx ta IIC:
cCSA Code of Protection	Class I, Div 1 and 2, Groups A, B, C and D; Class II, Div 1 and 2, Groups E, F, and G; Class III, Div 1 and 2; End. Type 4X. Ex d IIC; Ex e II:
Compliance Standards	CAN/CSA-C22.2 No 0-M91, CAN/CSA-C22.2 No 18-04, CAN/CSA-C22.2 No 25-1966, CAN/CSA-C22.2 No 30-M1986, CAN/CSA-C22.2 No.174-M1984, CAN/CSA-C22.2 No.94-M91, CAN/CSA-E60079-0:07, CAN/CSA-E60079-7:07, CAN/CSA-E60079-1:07, CAN/CSA-E612411, ANSI/UL 514B Edition 5, ANSI/UL 50 Edition 11, ANSI/UL 2225 Edition 4
EAC Certificate	TC RU C-GB.F605.B00138
CCOE / PESO (India) Certificate	P333688
RETIE Approval Number	03866
Marine Approvals	LRS: 01/00172 (E3) DNV: E-13848 ABS: 15-LD1410479-PDA
Ingress Protection Rating**	NEMA 4X & IP66
Cable Type	Corrugated & Interlocked Metal Clad Armor (MC) or TECK90, Continuously Welded Metal Clad Armor (MCHL), ACIC-HL, ACWU90-HL, RC90-HL, RA90-HL
Armor Clamping	360° Stainless Steel Grounding Spring (non-magnetic) (beryllium copper optional)
Jacket Sealing Technique	CMP Load Retention Seal
Sealing Area(s)	RapidEx Liquid Resin, Cable Outer Jacket
Cable Gland Material	Copper Free (<0.4%) Aluminum, Stainless Steel, Electroless Nickel Plated Brass

* Mechanical & Electrical Classifications applied as per IEC 62444 & EN 62444
 ** When CMP installation accessories are used. Refer to page 7 or www.cmp-products.com for further information.

Cable Gland Selection Table
 Refer to illustration at the top of the page

Order Reference (NPT with RapidEx Resin)			Entry Thread "C"		Minimum Thread Length "E"	Cable Armor Diameter "A"				Cable Jacket Diameter "B"		Max Over Conductors "G"	Across Flats "D"	Across Corners "D"	Nominal Assembly Length "F"	Shroud	Approx Weight Aluminum (Ozs)
Aluminum	Nickel Plated Brass	Stainless Steel	NPT	NPT Option		Armor Stop In		Armor Stop Out		Min	Max						
						Min	Max	Min	Max								
TMC2X-050A075X	TMC2X-050NB075X	TMC2X-050SS075X	1/2"	-	0.78	0.42	0.55	0.55	0.63	0.500	0.750	0.51	1.20	1.32	2.44	PVC06	2.29
TMC2X-075A075X	TMC2X-075NB075X	TMC2X-075SS075X	-	3/4"	0.80	0.42	0.55	0.55	0.63	-	-	0.51	-	-	-	-	-
TMC2X-075A099X	TMC2X-075NB099X	TMC2X-075SS099X	3/4"	-	0.80	0.60	0.65	0.65	0.89	0.690	0.990	0.71	1.48	1.63	2.96	PVC09	3.00
TMC2X-050A099X	TMC2X-050NB099X	TMC2X-050SS099X	-	1/2"	0.78	0.60	0.78	0.78	0.89	-	-	0.51	-	-	-	-	-
TMC2X-100A118X	TMC2X-100NB118X	TMC2X-100SS118X	1"	-	0.98	0.79	0.86	0.86	1.10	0.870	1.180	0.94	1.81	1.99	3.15	PVC11	5.11
TMC2X-075A118X	TMC2X-075NB118X	TMC2X-075SS118X	-	3/4"	0.80	0.79	0.98	0.98	1.10	-	-	0.71	-	-	-	-	-
TMC2X-125A137X	TMC2X-125NB137X	TMC2X-125SS137X	1 1/4"	-	1.00	0.94	1.08	1.08	1.28	1.020	1.370	1.20	2.05	2.26	3.55	PVC15	6.70
TMC2X-100A137X	TMC2X-100NB137X	TMC2X-100SS137X	-	1"	0.98	0.94	1.18	1.18	1.28	-	-	0.94	-	-	-	-	-
TMC2X-150A162X	TMC2X-150NB162X	TMC2X-150SS162X	1 1/2"	-	1.03	1.22	1.35	1.35	1.50	1.300	1.620	1.46	2.36	2.60	3.59	PVC18	8.82
TMC2X-125A162X	TMC2X-125NB162X	TMC2X-125SS162X	-	1 1/4"	1.00	1.22	1.42	1.42	1.50	-	-	1.20	-	-	-	-	-
TMC2X-150A190X	TMC2X-150NB190X	TMC2X-150SS190X	1 1/2"	-	1.03	-	-	1.51	1.72	1.570	1.900	1.46	2.56	2.82	3.59	PVC37	9.45
TMC2X-125A190X	TMC2X-125NB190X	TMC2X-125SS190X	-	1 1/4"	1.00	-	-	1.51	1.72	-	-	1.20	-	-	-	-	-
TMC2X-200A200X	TMC2X-200NB200X	TMC2X-200SS200X	2"	-	1.53	1.57	1.70	1.70	1.88	1.650	2.000	1.63	2.75	3.03	3.76	PVC21	11.06
TMC2X-150A200X	TMC2X-150NB200X	TMC2X-150SS200X	-	1 1/2"	1.03	1.57	1.70	1.70	1.88	-	-	1.46	-	-	-	-	-
TMC2X-250A233X	TMC2X-250NB233X	TMC2X-250SS233X	2 1/2"	-	1.63	-	-	1.81	2.21	1.910	2.330	2.13	2.95	3.25	3.97	PVC28	12.77
TMC2X-150A233X	TMC2X-150NB233X	TMC2X-150SS233X	-	2"	1.53	-	-	1.81	2.21	-	-	1.90	-	-	-	-	-
TMC2X-150A233X	TMC2X-150NB233X	TMC2X-150SS233X	-	1 1/2"	1.03	-	-	1.81	2.21	-	-	1.46	-	-	-	-	-
TMC2X-300A272X	TMC2X-300NB272X	TMC2X-300SS272X	3"	-	1.63	2.14	2.46	2.17	2.61	2.270	2.720	2.55	3.54	3.89	4.10	PVC31	24.69
TMC2X-250A272X	TMC2X-250NB272X	TMC2X-250SS272X	-	2 1/2"	1.63	2.14	2.46	2.46	2.61	-	-	2.13	-	-	-	-	-
TMC2X-200A272X	TMC2X-200NB272X	TMC2X-200SS272X	-	2"	1.53	2.14	2.46	2.46	2.61	-	-	1.90	-	-	-	-	-
TMC2X-350A325X	TMC2X-350NB325X	TMC2X-350SS325X	3 1/2"	-	1.68	2.49	2.78	2.78	2.97	2.620	3.250	2.98	4.33	4.76	4.67	PVC32	42.68
TMC2X-300A325X	TMC2X-300NB325X	TMC2X-300SS325X	-	3"	1.63	2.49	2.78	2.78	2.97	-	-	2.98	-	-	-	-	-
TMC2X-400A376X	TMC2X-400NB376X	TMC2X-400SS376X	4"	-	1.73	2.95	3.45	3.45	3.54	3.160	3.760	3.38	4.84	5.32	4.95	LSF33	53.44
TMC2X-350A376X	TMC2X-350NB376X	TMC2X-350SS376X	-	3 1/2"	1.68	2.95	3.45	3.45	3.54	-	-	3.38	-	-	-	-	-
TMC2X-400A425X	TMC2X-400NB425X	TMC2X-400SS425X	4"	-	1.73	-	-	3.56	3.94	3.700	4.250	3.38	5.23	5.75	5.16	LSF34	59.19

*Order Code Example: TMC2X-050A075 - "TMC2X" (Gland Type) - "050" (1/2" NPT Thread) - "A" (Material Aluminum) - "075" (Max Cable Diameter 0.75")

Dimensions are displayed in inches unless otherwise stated

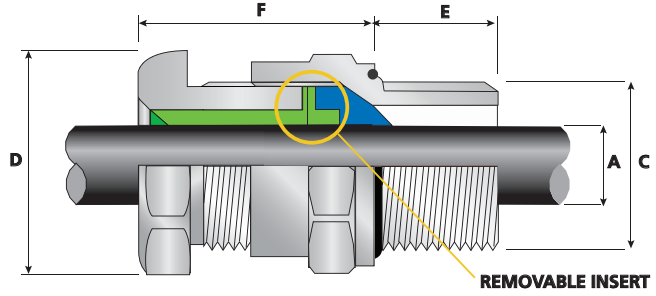

TC Globally Approved, Hazardous (Classified) Location Cable Gland

For all types of Unarmored Tray Cables, Flexible Cables & Cord

- Aluminum, nickel plated brass or stainless steel design
- Increased cable range with removable insert
- Optional thread sizes
- -76°F to 230°F
- Globally marked, cCSAus, IECEx & ATEX
- Heavy duty design
- Entry thread seal as standard



TECHNICAL DATA	
Design Specification	BS 6121:Part 1:1989, IEC 62444, EN 62444
Mechanical Classifications*	Impact = Level 8, Cable Anchorage = Class D
ATEX Certificate	SIRA09ATEX1092X
Code of Protection	Ex II 2 GD, Ex d IIC Gb, Ex e IIC Gb, Ex ta IIC Da
Compliance Standards	EN 60079-0,1,7, EN 61241,1
IECEx Certificate	IECEx SIR 09.0042X
Code of Protection	Ex d IIC Gb, Ex e IIC Gb, Ex ta IIC Da
Compliance Standards	IEC 60079-0,1,7 IEC 612411
cCSAus Certificate	2220601
CSAus Code of Protection	Class I, Div. 2, Groups A, B, C and D; Class II, Div. 2, Groups E, F, and G; Class III, Div. 2; Encl. Type 4X.
cCSA Code of Protection	Class I, Zone 1, AEx e: Class I, Div. 2, Groups A, B, C and D; Class II, Div. 2, Groups E, F, and G; Class III, Div. 2; Encl. Type 4X.
Compliance Standards	CAN/CSA-C22.2 Various Sections (See Certificate) CAN/CSA-E60079-0,7, CAN/CSA-E6124111, ANSI/UL 514B Ed 5, ANSI/UL 50E11, ANSI/UL 60079-0,7
EAC Certificate	TC RU C-GB.ГБ05.B.00138
RETIE Approval Number	03866
Marine Approvals	LRS: 01/00172 (E3) DNV: E-13848 ABS: 15-LD1410479-PDA
Ingress Protection Rating**	IP66, IP67 & IP68***
NEMA Rating**	NEMA 4X
Cable Gland Material	Copper Free (<0.4%) Aluminum, Nickel Plated Brass, Stainless Steel
Cable Type	Tray Cable & Cords, Unarmored / Braid (IEC)
Sealing Technique	CMP Displacement Seal with Removable Insert
Sealing Area(s)	Cable Outer Jacket

* Mechanical & Electrical Classifications applied as per IEC 62444 & EN 62444
 ** When CMP installation accessories are used. Refer to page 7 or www.cmp-products.com for further information.
 *** IP68 tested to a minimum depth of 30 metres for 12 hours, alternate depths / durations can be provided upon request

Cable Gland Selection Table
 Refer to illustration at the top of the page

Order Reference (NPT)			Entry Thread "C"		Minimum Thread Length "E"	Cable Range "A"		Cable Range "A"		Across Flats "D"	Across Corners "D"	Nominal Assembly Length "F"	Shroud	Approx Weight Aluminum (Ozs)
Aluminum	Nickel Plated Brass	Stainless Steel	NPT	NPT Option		Insert		No Insert						
						Min	Max	Min	Max					
TC-050A0281RA	TC-050NB0281RA	TC-050SS0281RA	1/2"	-	0.78	-	-	-	-	1.20	1.32	1.20	PVC05	1.94
TC-075A0281RA	TC-075NB0281RA	TC-075SS0281RA	-	3/4"	0.80	0.13	0.28	-	-	1.48	1.59	1.24	PVC05	1.69
TC-050A0551RA	TC-050NB0551RA	TC-050SS0551RA	1/2"	-	0.78	-	-	-	-	1.20	1.32	1.20	PVC06	1.94
TC-075A0551RA	TC-075NB0551RA	TC-075SS0551RA	-	3/4"	0.80	0.26	0.41	0.41	0.55	1.48	1.63	1.24	PVC06	1.69
TC-075A0791RA	TC-075NB0791RA	TC-075SS0791RA	3/4"	-	0.80	-	-	-	-	1.48	1.63	1.24	PVC09	1.69
TC-100A0791RA	TC-100NB0791RA	TC-100SS0791RA	-	1"	0.98	0.44	0.61	0.61	0.79	1.81	1.96	1.65	PVC09	3.17
TC-100A1041RA	TC-100NB1041RA	TC-100SS1041RA	1"	-	0.98	-	-	-	-	1.81	1.99	-	-	-
TC-125A1041RA	TC-125NB1041RA	TC-125SS1041RA	-	1 1/4"	1.01	0.67	0.85	0.85	1.04	2.05	2.21	1.65	PVC11	3.88
TC-125A1271RA	TC-125NB1271RA	TC-125SS1271RA	1 1/4"	-	1.01	-	-	-	-	2.05	2.25	-	-	-
TC-150A1271RA	TC-150NB1271RA	TC-150SS1271RA	-	1 1/2"	1.03	0.93	1.10	1.10	1.27	2.36	2.55	1.65	PVC13	4.94
TC-150A1501RA	TC-150NB1501RA	TC-150SS1501RA	1 1/2"	-	1.03	-	-	-	-	2.36	2.60	-	-	-
TC-200A1501RA	TC-200NB1501RA	TC-200SS1501RA	-	2"	1.06	1.22	1.37	1.37	1.50	2.95	3.19	1.65	PVC21	6.00
TC-200A1741RA	TC-200NB1741RA	TC-200SS1741RA	2"	-	1.06	-	-	-	-	2.76	2.98	-	-	-
TC-250A1741RA	TC-250NB1741RA	TC-250SS1741RA	-	2 1/2"	1.57	-	-	1.40	1.74	3.54	3.83	1.63	PVC21	8.64
TC-200A1971RA	TC-200NB1971RA	TC-200SS1971RA	2"	-	1.06	-	-	-	-	2.76	3.03	-	-	-
TC-250A1971RA	TC-250NB1971RA	TC-250SS1971RA	-	2 1/2"	1.57	-	-	1.63	1.97	3.54	3.83	1.74	PVC28	8.29
TC-250A2201RA	TC-250NB2201RA	TC-250SS2201RA	2 1/2"	-	1.57	-	-	-	-	3.54	3.83	-	-	-
TC-300A2201RA	TC-300NB2201RA	TC-300SS2201RA	-	3"	1.63	-	-	1.86	2.21	4.33	4.68	1.74	PVC28	13.58
TC-250A2441RA	TC-250NB2441RA	TC-250SS2441RA	2 1/2"	-	1.57	-	-	-	-	3.54	3.90	1.79	PVC31	13.58
TC-300A2441RA	TC-300NB2441RA	TC-300SS2441RA	-	3"	1.63	-	-	2.13	2.44	4.33	4.68	-	-	-
TC-300A2681RA	TC-300NB2681RA	TC-300SS2681RA	3"	-	1.63	-	-	-	-	4.33	4.68	1.79	PVC31	23.63
TC-350A2681RA	TC-350NB2681RA	TC-350SS2681RA	-	3 1/2"	1.69	-	-	2.41	2.68	4.84	5.23	-	-	-
TC-350A3151RA	TC-350NB3151RA	TC-350SS3151RA	3 1/2"	-	1.69	-	-	-	-	4.84	5.23	-	-	-
TC-400A3151RA	TC-400NB3151RA	TC-400SS3151RA	-	4"	1.73	2.62	3.15	2.62	3.15	5.25	5.67	2.50	LSF33	34.22
TC-400A3541RA	TC-400NB3541RA	TC-400SS3541RA	4"	-	1.73	-	-	2.99	3.54	5.25	5.67	2.36	LSF34	38.80

Order Code Example: TC-050A0281RA131 - "TC" (Type Gland) - "050" (1/2" NPT Thread) - "A" (Material Aluminum) - "028" (Max Cable Diameter 0.28")

Dimensions are displayed in inches unless otherwise stated

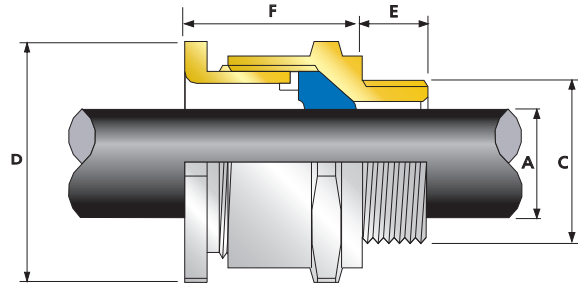

A2F Ex e Ex d Ex nR Ex ta

A2F Globally Approved, Hazardous (Classified) Location Cable Gland

For all types of Unarmored & Braided Cables

- Aluminum, nickel plated brass or stainless steel design
- Optional thread sizes
- Displacement type flameproof seal
- Deluge protected
- -76°F to 230°F
- Globally marked, CSA, IECEx & ATEX
- As standard in nickel plated brass with NPT thread form



TECHNICAL DATA	
Design Specification	BS 6121:Part 1:1989, IEC 62444, EN 62444
Mechanical Classifications*	Impact = Level 8, Cable Anchorage = Class B
Enclosure Protection	IK10 to IEC 62262 (20 joules) Brass & Stainless Steel only
ATEX Certificate	SIRA13ATEX1068X, SIRA13ATEX4074X
Code of Protection	⊕ II 2G, II 1D Ex d IIC Gb, Ex e IIC Gb, Ex ta IIIC Da ⊕ II 3G Ex nR IIC Gc I M2 Ex d I Mb, Ex e I Mb
Compliance Standards	EN 60079-0,1,7,15,31
IECEx Certificate	IECEx SIR 13.0023X, IECEx SIM 14.0006
Code of Protection	Ex d IIC Gb, Ex e IIC Gb, Ex nR IIC Gc, Ex ta IIIC Da, Ex d I Mb, Ex e I Mb
Compliance Standards	IEC 60079-0,1,7,15,31
CSA Certificate	1211841
Code of Protection	Class I, Div. 2 Groups B, C and D; Class II, Div. 2 Groups E, F and G; Class III, Div. 2; Type 4X: Oil Resistant II: Ex d IIC, Ex e II, Ex nR II
Compliance Standards	C22.2 No 0,0,4, 94, 174, CAN/CSA-E60079-0,1,7,15
EAC Certificate (Formerly GOST R, K & B)	TC RU C-GB.ГБ05.В00138
KCC Certificate	13_GA480_0748X ; 13_GA480_0749X ; 13_GA480_0750X ; 14_GA480_0251X
NEPSI Certificate	GYJ13.1140X / GYJ13.1282X
INMETRO Approval	TÜV 12.0619X
CCOE / PESO Certificate (India)	P333688
RETIE Approval Number	03866
Marine Approvals	LRS: 01/00172 (E3), DNV: E-13848, ABS: 14-LD234401A-4-PDA
Ingress Protection Rating**	IP66, IP67 & IP68***
NEMA Rating**	NEMA 4X
Deluge Protection Compliance	DTS01 : 91
Cable Gland Material	Copper Free (<0.4%) Aluminum, Nickel Plated Brass, Stainless Steel
Seal Material	CMP SOLO LSF Halogen Free Thermoset Elastomer
Cable Type	Unarmored & Braided (when terminated inside enclosure)
Sealing Technique	CMP Unique Displacement Seal Concept
Sealing Area(s)	Cable Outer Jacket

Cable Gland Selection Table
Refer to illustration at the top of the page.

Cable Gland Size	Available Entry Threads "C"				Overall Cable Diameter "A"		Across Flats "D"	Across Corners "D"	Protrusion Length "F"	Combined Ordering Reference ("Nickel Plated Brass NPT")			Shroud	Cable Gland Weight (Ozs)
	NPT	NPT (Option)	Metric (Option)	Thread Length (NPT) "E"	Min	Max	Max	Max		Size	Type	Ordering Suffix		
20S16	1/2"	3/4"	M20	0.78	0.13	0.34	0.95	1.04	1.04	20S16	A2F	1RA531	PVC05	2.30
20S	1/2"	3/4"	M20	0.78	0.24	0.46	0.95	1.04	1.00	20S	A2F	1RA531	PVC05	2.02
20	1/2"	3/4"	M20	0.78	0.26	0.55	1.06	1.17	1.06	20	A2F	1RA531	PVC05	2.04
25	3/4"	1"	M25	0.80	0.44	0.79	1.42	1.56	1.40	25	A2F	1RA532	PVC10	3.66
32	1"	1 1/4"	M32	0.98	0.67	1.04	1.61	1.78	1.35	32	A2F	1RA533	PVC10	4.45
40	1 1/4"	1 1/2"	M40	1.01	0.93	1.27	1.97	2.17	1.37	40	A2F	1RA534	PVC13	6.64
50S	1 1/2"	2"	M50	1.03	1.22	1.50	2.17	2.38	1.34	50S	A2F	1RA535	PVC15	8.12
50	2"	2 1/2"	M50	1.06	1.40	1.73	2.56	2.82	1.52	50	A2F	1RA536	PVC19	15.26
63S	2"	2 1/2"	M63	1.06	1.63	1.97	2.76	3.03	1.42	63S	A2F	1RA536	PVC21	12.41
63	2 1/2"	3"	M63	1.57	1.86	2.20	3.15	3.47	1.41	63	A2F	1RA537	PVC24	25.55
75S	2 1/2"	3"	M75	1.57	2.13	2.44	3.15	3.47	1.46	75S	A2F	1RA537	PVC24	18.54
75	3"	3 1/2"	M75	1.63	2.41	2.67	3.94	4.33	1.58	75	A2F	1RA538	PVC30	44.56
90	3 1/2"	4"	M90	1.69	2.62	3.15	4.25	4.68	2.18	90	A2F	1RA539	PVC31	59.90
100	3 1/2"	4"	M100	1.69	2.99	3.58	4.85	5.34	2.19	100	A2F	1RA539	LSF33	52.90
115	4"	5"	M115	1.73	3.39	3.85	5.25	5.78	2.57	115	A2F	1RA5310	LSF34	76.71
130	5"	-	M130	1.84	3.82	4.52	6.00	6.60	2.91	130	A2F	1RA5311	LSF35	138.91

*For material options add the following suffix to the Ordering Reference, Brass (no suffix required), Nickel Plated Brass 'S', 316 Grade Stainless Steel '4', Copper Free Aluminum '1'
For NPT options add the following digits to the material suffix; 1/2" = 31, 3/4" = 32, 1" = 33, 1 1/4" = 34, 1 1/2" = 35, 2" = 36, 2 1/2" = 37, 3" = 38, 3 1/2" = 39, 4" = 310 (Brass requires prefix '0')
Examples: 32A2F1RA534 = Nickel Plated Brass 1 1/4" NPT, 50SA2F1RA035 = Brass 1 1/2" NPT, 25A2F1RA432 = Stainless Steel 3/4" NPT, 20A2F1RA5 = Nickel Plated Brass M20

Dimensions are displayed in inches unless otherwise stated

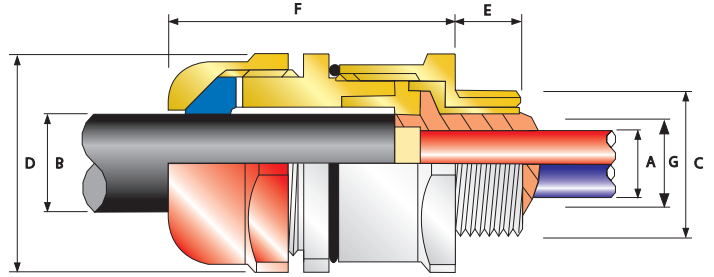

PXSS2K



PXSS2K Globally Approved, Hazardous (Classified) Location Barrier Cable Gland

For all types of Unarmored Cables

- Direct & remote installation
- Superior levels of cable retention
- Displacement type environmental seal
- Compound barrier type flameproof seal
- Deluge protected
- Disconnectable, union feature design
- -76°F to 185°F / -60°C to 85°C
- Globally marked, UL, cCSAus, IECEx & ATEX
- As standard in nickel plated brass with NPT thread form



TECHNICAL DATA	
Design Specification	BS 6121:Part 1:1989, IEC 62444, EN 62444
Mechanical Classifications*	Impact = Level 8, Cable Anchorage = Class B
Enclosure Protection	IK10 to IEC 62262 (20 joules) Brass & Stainless Steel only
ATEX Certificate	SIRA13ATEX1072X, SIRA13ATEX4078X
Code of Protection	Ⓜ II 2 GD, II 1D, Ex d IIC Gb, Ex e IIC Gb, Ex ta IIC Da Ⓜ II 3 G Ex nR IIC Gc, Ⓜ IM2 Ex d I Mb, Ex e I Mb
Compliance Standards	EN 60079-0,1,7,15,31
IECEx Certificate	IECEx SIR 13.0027X
Code of Protection	Ex d IIC Gb, Ex e IIC Gb, Ex nR IIC Gc, Ex ta IIC Da, Ex d I Mb, Ex e I Mb
Compliance Standards	IEC 60079-0,1,7,15,31
cCSAus Certificate (20S16 - 90)	2288626
CSAus Code of Protection***	Class I, Div. 1, 2 Groups A, B, C and D; Class II, Div. 1, 2 Groups E, F and G; Class III, Div. 1, 2; Type 4X: Oil Resistant II: Class I, Zone 1 AEx d IIC Gb, AEx e IIC Gb, Class I, Zone 2 AEx nR IIC Gc, Class I, Zone 20 AEx ta IIC Da
cCSA Code of Protection***	Class I, Div. 1, 2 Groups A, B, C and D; Class II, Div. 1, 2 Groups E, F and G; Class III, Div. 1, 2; Type 4X: Oil Resistant II: Ex d IIC Gb, Ex e IIC Gb, Ex nR IIC Gc, Ex ta IIC Da
Compliance Standards	CAN/CSA-C22.2 No 0,18,25,30,174,94, CAN/CSA-E60079-0,1,7,15,31, CAN/CSA-E6124111 Part 11, ANSI/UL 514B Ed 5, ANSI/UL 50 Ed 11, ANSI/UL 2225 Ed 4, UL60079
UL Certificate	E201187B, E253914
Code of Protection	Class I, Groups A,B,C,D, Class II, Groups F,G Class I, Zone 1, AEx d IIC, AEx e II
Compliance Standards	UL 2225, CSA C22.2 No 174 UL 2225, UL 514B, UL 60079-0, UL 60079-7
EAC Certificate	TC RU C-GB.Г505.В00138
CCOE / PESO (India) Certificate	P333688
NEPSI Certificate	GY13.1140X / GY13.1282X
INMETRO Approval	TÜV 12.2073X
RETIE Approval Number	03866
Marine Approvals	LRS: 01/00172 (E3) DNV: E-13848 ABS: 14-LD234401A-4-PDA
Ingress Protection Rating**	IP66, IP67 & IP68****
Deluge Protection Compliance	DTS01 : 91
NEMA Rating**	NEMA 4X
Cable Gland Material	Electroless Nickel Plated Brass, Copper Free (<0.4%) Aluminum, Stainless Steel
Seal Material	CMP SOLO LSF Halogen Free Thermoset Elastomer / Epoxy Barrier Compound
Cable Type	Unarmored***
Sealing Technique	CMP Unique Displacement Seal Concept
Sealing Area(s)	Inner Compound Barrier & Outer Sheath

* Mechanical & Electrical Classifications applied as per IEC 62444 & EN 62444
 ** When CMP installation accessories are used. Refer to page 7 or www.cmp-products.com for further information.
 *** Where the cable is permitted by code (NEC and/or CEC)
 **** IP68 tested to a minimum depth of 30 metres for 12 hours, alternate depths / durations can be provided upon request

Cable Gland Selection Table

Refer to illustration at the top of the page

Cable Gland Size	Available Entry Threads "C" (Alternative Metric Thread Lengths Available)				Number of Cores	Diameter Over Conductors "A"	Cable Bedding Diameter "G"	Overall Cable Diameter "B"			Across Flats "D"	Across Corners "D"	Protrusion Length "F"	Combined Ordering Reference (*Nickel Plated Brass NPT)			Shroud	Cable Gland Weight (Ozs)
	NPT	NPT (Option)	Metric (Option)	Thread Length (NPT) "E"				Max	Max	Max				Min	Max	Max		
20S16	1/2"	3/4"	M20	0.78	11	0.34	0.34	0.12	0.34	1.18	1.30	2.09	20S16	PXSS2K	1RA531	PVC06	7.06	
20S	1/2"	3/4"	M20	0.78	11	0.46	0.46	0.24	0.46	1.18	1.30	2.09	20S	PXSS2K	1RA531	PVC06	7.06	
20	1/2"	3/4"	M20	0.78	11	0.50	0.51	0.26	0.55	1.18	1.30	2.13	20	PXSS2K	1RA531	PVC06	7.06	
20L	1/2"	3/4"	M20	0.78	11	0.50	0.51	0.39	0.63	1.18	1.30	2.13	20L	PXSS2K	1RA531	PVC06	7.06	
25	3/4"	1"	M25	0.80	21	0.69	0.70	0.44	0.79	1.42	1.56	2.36	25	PXSS2K	1RA532	PVC09	11.64	
32	1"	1 1/4"	M32	0.98	38	0.93	0.94	0.67	1.04	1.61	1.78	2.41	32	PXSS2K	1RA533	PVC10	13.76	
32L	1"	1 1/4"	M32	0.98	38	0.93	0.94	0.79	1.08	1.61	1.78	2.41	32L	PXSS2K	1RA533	PVC10	13.76	
40	1 1/4"	1 1/2"	M40	1.01	59	1.18	1.19	0.87	1.26	1.97	2.17	2.46	40	PXSS2K	1RA534	PVC13	19.75	
50S	1 1/2"	2"	M50	1.03	89	1.44	1.45	1.16	1.50	2.17	2.38	2.57	50S	PXSS2K	1RA535	PVC15	23.28	
50	2"	2 1/2"	M50	1.06	89	1.61	1.63	1.40	1.73	2.36	2.60	2.66	50	PXSS2K	1RA536	PVC18	25.75	
63S	2"	2 1/2"	M63	1.06	115	1.89	1.91	1.58	1.97	2.76	3.03	2.80	63S	PXSS2K	1RA536	PVC21	37.74	
63	2 1/2"	3"	M63	1.57	115	2.11	2.13	1.86	2.20	2.95	3.25	2.77	63	PXSS2K	1RA537	PVC23	37.39	
75S	2 1/2"	3"	M75	1.57	140	2.36	2.37	2.08	2.44	3.15	3.47	2.97	75S	PXSS2K	1RA537	PVC25	45.86	
75	3"	3 1/2"	M75	1.63	140	2.53	2.53	2.33	2.67	3.35	3.68	2.95	75	PXSS2K	1RA538	PVC27	45.86	
90	3 1/2"	4"	M90	1.69	200	2.97	2.98	2.62	3.13	4.25	4.68	3.73	90	PXSS2K	1RA539	PVC31	106.53	
100	3 1/2"	4"	M100	1.69	200	3.37	3.38	2.99	3.58	4.84	5.33	3.40	100	PXSS2K	1RA5310	LSF33	141.10	

* Note : For material options please change the suffix in the Ordering Reference : Brass (no suffix required), Nickel Plated Brass "5" (as standard), 316 Grade Stainless Steel "4", Copper Free Aluminum "1"
 For NPT options please change the following digits after the material suffix; 1/2" = 31, 3/4" = 32, 1" = 33, 1 1/4" = 34, 1 1/2" = 35, 2" = 36, 2 1/2" = 37, 3" = 38, 3 1/2" = 39 (Brass requires prefix "0")
 Examples: 32PXSS2K1RA534 = Nickel Plated Brass 1 1/4" NPT, 50SPXSS2K1RA035 = Brass 1 1/2" NPT, 25PXSS2K1RA432 = Stainless Steel 3/4" NPT, 20PXSS2K1RA5 Nickel Plated Brass M20

Dimensions are displayed in inches unless otherwise stated



RAPID Ex

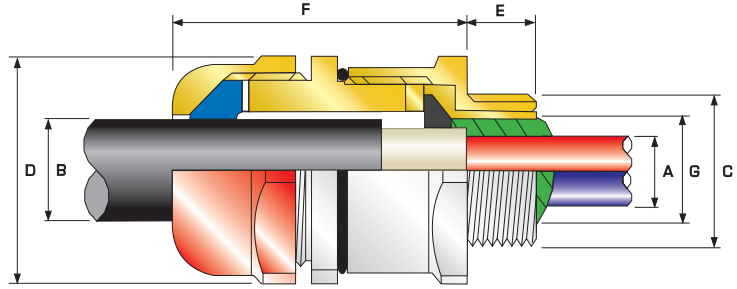

PXSS2KREX



PXSS2KREX Globally Approved, Hazardous (Classified) Location Barrier Cable Gland

For all types of Unarmored Cables

- RapidEx liquid pour sealing system
 - Enhances reliability, reduces risk
 - Reduces man hours
 - Reduces cost
- Direct & remote installation
- Superior levels of cable retention
- Displacement type environmental seal
- Deluge protected
- Disconnectable, union feature design
- -76°F to 185°F / -60°C to 85°C
- Globally marked, cCSAus, IECEx & ATEX
- As standard in nickel plated brass with NPT thread form



Supplied in pack with RapidEx resin

TECHNICAL DATA

Design Specification	BS 6121:Part 1:1989, IEC 62444, EN 62444
Mechanical Classifications*	Impact = Level 8, Cable Anchorage = Class B
Enclosure Protection	IK10 to IEC 62262 (20 joules) Brass & Stainless Steel only
ATEX Certificate	SIRA13ATEX1072X, SIRA13ATEX4078X
Code of Protection	Ⓜ II 2G, II 1D, Ex d IIC Gb, Ex e IIC Gb, Ex ta IIIC Da Ⓜ II 3G Ex nR IIC Gc, Ⓜ IM2 Ex d I Mb, Ex e I Mb
Compliance Standards	EN 60079-0,1,7,15,31
IECEx Certificate	IECEx SIR 13.0027X
Code of Protection	Ex d IIC Gb, Ex e IIC Gb, Ex nR IIC Gc, Ex ta IIIC Da, Ex d I Mb, Ex e I Mb
Compliance Standards	IEC 60079-0,1,7,15,31
cCSAus Certificate (20S16 - 90)	2288626
CSAus Code of Protection***	Class I, Div. 1, 2 Groups A, B, C and D; Class II, Div. 1, 2 Groups E, F and G; Class III, Div. 1, 2; Type 4X: Oil Resistant II: Class I, Zone 1 AEx d IIC Gb, AEx e IIC Gb, Class I, Zone 2 AEx nR IIC Gc, Class I, Zone 20 AEx ta IIIC Da
cCSA Code of Protection***	Class I, Div. 1, 2 Groups A, B, C and D; Class II, Div. 1, 2 Groups E, F and G; Class III, Div. 1, 2; Type 4X: Oil Resistant II: Ex d IIC Gb, Ex e IIC Gb, Ex nR IIC Gc, Ex ta IIIC Da
Compliance Standards	CAN/CSA-C22.2 No 0,18,25,30,94,174, CAN/CSA-E60079-0,1,7,31 CAN CSA-E6124111, Part 11, ANSI/UL 514B Ed 5, ANSI/UL 50 Ed 11, ANSI/UL 2225 Ed 4, UL60079-0:07
EAC Certificate	TC RU C-GB.ГБ05.В00138
CCOE / PESO (India) Certificate	P333688
NEPSI Certificate	GYJ13.1140X / GYJ13.1282X
INMETRO Approval	TÜV 12.2073X
RETIE Approval Number	03866
Marine Approvals	LRs: 01/00172 (E3) DNV: E-13848 ABS: 14-LD234401A-4-PDA
Ingress Protection Rating**	IP66, IP67 & IP68****
Deluge Protection Compliance	DTS01 : 91
NEMA Rating**	NEMA 4X
Cable Gland Material	Electroless Nickel Plated Brass, Copper Free (<0.4%) Aluminum, Stainless Steel
Seal Material	CMP SOLO LSF Halogen Free Thermoset Elastomer / RapidEx Barrier Compound
Cable Type	Unarmored***
Sealing Technique	Unique CMP 'LRS' Outer Seal (Load Retention Seal)
Sealing Area(s)	RapidEx Resin Barrier & Cable Outer Sheath

* Mechanical & Electrical Classifications applied as per IEC 62444 & EN 62444

** When CMP installation accessories are used. Refer to page 7 or www.cmp-products.com for further information.

***Where the cable is permitted by code (NEC and/or CEC)

**** IP68 tested to a minimum depth of 30 metres for 12 hours, alternate depths / durations can be provided upon request

Cable Gland Selection Table

Refer to illustration at the top of the page

Cable Gland Size	Available Entry Threads "C" (Alternative Metric Thread Lengths Available)				Number of Cores	Diameter Over Conductors "A"	Cable Bedding Diameter "G"	Overall Cable Diameter "B"		Across Flats "D"	Across Corners "D"	Protrusion Length "F"	Combined Ordering Reference (*Nickel Plated Brass NPT)			Shroud	Cable Gland Weight (Ozs)
	NPT	NPT (Option)	Metric (Option)	Thread Length (NPT) "E"				Max	Max				Min	Max	Size		
20S16	1/2"	3/4"	M20	0.78	11	0.34	0.34	0.12	0.34	1.18	1.30	2.09	20S16	PXSS2KREX	1EX531	PVC06	7.06
20S	1/2"	3/4"	M20	0.78	11	0.46	0.46	0.24	0.46	1.18	1.30	2.09	20S	PXSS2KREX	1EX531	PVC06	7.06
20	1/2"	3/4"	M20	0.78	11	0.50	0.51	0.26	0.55	1.18	1.30	2.13	20	PXSS2KREX	1EX531	PVC06	7.06
20L	1/2"	3/4"	M20	0.78	11	0.50	0.51	0.39	0.63	1.18	1.30	2.13	20L	PXSS2KREX	1EX531	PVC06	7.06
25	3/4"	1"	M25	0.80	21	0.69	0.70	0.44	0.79	1.42	1.56	2.36	25	PXSS2KREX	1EX532	PVC09	11.64
32	1"	1 1/4"	M32	0.98	38	0.93	0.94	0.67	1.04	1.61	1.78	2.41	32	PXSS2KREX	1EX533	PVC10	13.76
32L	1"	1 1/4"	M32	0.98	38	0.93	0.94	0.79	1.08	1.61	1.78	2.41	32L	PXSS2KREX	1EX533	PVC10	13.76
40	1 1/4"	1 1/2"	M40	1.01	59	1.18	1.19	0.87	1.26	1.97	2.17	2.46	40	PXSS2KREX	1EX534	PVC13	19.75
50S	1 1/2"	2"	M50	1.03	89	1.44	1.45	1.16	1.50	2.17	2.38	2.57	50S	PXSS2KREX	1EX535	PVC15	23.28
50	2"	2 1/2"	M50	1.06	89	1.61	1.63	1.40	1.73	2.36	2.60	2.66	50	PXSS2KREX	1EX536	PVC18	25.75
63S	2"	2 1/2"	M63	1.06	115	1.89	1.91	1.58	1.97	2.76	3.03	2.80	63S	PXSS2KREX	1EX536	PVC21	37.74
63	2 1/2"	3"	M63	1.57	115	2.11	2.13	1.86	2.20	2.95	3.25	2.77	63	PXSS2KREX	1EX537	PVC23	37.39
75S	2 1/2"	3"	M75	1.57	140	2.36	2.37	2.08	2.44	3.15	3.47	2.97	75S	PXSS2KREX	1EX537	PVC25	45.86
75	3"	3 1/2"	M75	1.63	140	2.53	2.53	2.33	2.67	3.35	3.68	2.95	75	PXSS2KREX	1EX538	PVC27	45.86
90	3 1/2"	4"	M90	1.69	200	2.97	2.98	2.62	3.13	4.25	4.68	3.73	90	PXSS2KREX	1EX539	PVC31	106.53
100	3 1/2"	4"	M100	1.69	200	3.37	3.38	2.99	3.58	4.84	5.33	3.40	100	PXSS2KREX	1EX5310	LSF33	141.10

*Note : For material options please change the suffix in the Ordering Reference ; Brass (no suffix required), Nickel Plated Brass "5" (as standard), 316 Grade Stainless Steel "4", Copper Free Aluminum "1" For NPT options please change the following digits after the material suffix ; 1/2" = 31, 3/4" = 32, 1" = 33, 1 1/4" = 34, 1 1/2" = 35, 2" = 36, 2 1/2" = 37, 3" = 38, 3 1/2" = 39, 4" = 310 (Brass requires prefix "0")

Examples: 32PXSS2KREX1RA534 = Nickel Plated Brass 1 1/4" NPT, 50SPXSS2KREX1RA035 = Brass 1 1/2" NPT, 25PXSS2KREX1RA432 = Stainless Steel 3/4" NPT, 20PXSS2KREX1RA5 Nickel Plated Brass M20

Dimensions are displayed in inches unless otherwise stated



TRITON
CDS

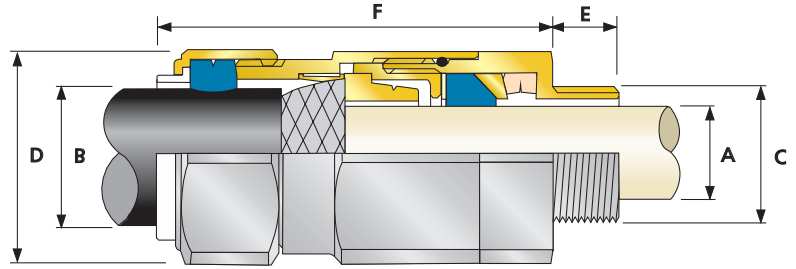

T3CDS

Ex e Ex d Ex nR Ex ta

Triton CDS (T3CDS) Globally Approved, Hazardous (Classified) Location Cable Gland

For all types of Armored Cables

- Fully sequential, three step installation procedure
- Reduces installation times, cost & risk
- Direct & remote installation
- Unique compensating displacement seal system (CDS)
 - Metal-to-metal installation every time regardless of cable diameter
- Designed to reduce the effects of Coldflow
- Integral protected deluge seal
- Controlled outer 'load retention' seal
- Unique OSTG prevents overtightening
- -76°F to 266°F (standard), -4°F to 392°F (ThermEx option)
- Globally marked, UL, cCSAus, IECEx & ATEX
- As standard in nickel plated brass with NPT thread form



† Grooved Cone (X) is predominantly used for Wire Braid (e.g. GSWB, TCWB), Steel Tape Armor (STA, DSTA) and Aluminum Strip Armor (ASA) but is also suitable for Single Wire Armor (SWA), Aluminum Wire Armor (AWA) and Pliable Wire Armor (PWA) if the range is outside that of the Stepped Cone (W).

Grooved Cone (X) dimensions shown in the Cable Gland Selection Table below are for a double wire strand of braid armor cables. Tapes can also be doubled over. For cables that have only a single layer of armor such as SWA the clamping range should be used as shown in the table below.

Stepped (W) Cone is suitable for Single Wire Armor (SWA), or Aluminum Wire Armor (AWA) cables.

TECHNICAL DATA

Design Specification	BS 6121:Part 1:1989, IEC 62444, EN 62444
Mechanical Classification*	Impact = Level 8, Cable Anchorage = Class D
Enclosure Protection	IK10 to IEC 62262 (20 joules) Brass & Stainless Steel only
Electrical Classification*	Category B (Category A when used with braid, tape or pliable wire armor cables)
ATEX Certificate	SIRA13ATEX1073X, SIRA13ATEX4079X
Code of Protection	Ⓜ II 2G, II 1D, Ex d IIC Gb, Ex e IIC Gb, Ex ta IIIC Da, Ⓜ II 3G Ex nR IIC Gc, Ⓜ I M2, Ex d I Mb, Ex e I Mb
Compliance Standards	EN60079-0,1,7,15,31
IECEx Certificate	IECEx SIR 13.0028X, IECEx SIM 14.0007X
Code of Protection	Ex d IIC Gb, Ex e IIC Gb, Ex nR IIC Gc, Ex ta IIIC Da, Ex d I Mb, Ex e I Mb
Compliance Standards	IEC 60079-0,1,7,15,31
cCSAus Certificate (20S16 - 90)	1310517
CSAus Code of Protection	Class I, Div 2, Groups A,B,C and D, Class II, Div 2, Groups E,F and G, Class III, Enclosure Type 3, 4 and 4X, Class I, Zone 1, AEx e II, AEx nR II
cCSA Code of Protection	Class I, Div 2, Groups A,B,C and D, Class II, Div 2, Groups E,F and G, Class III, Enclosure Type 3, 4 and 4X, Ex d IIC, Ex e IIC, Ex nR II
Compliance Standards	CAN/CSA-C22.2 No 0, 18, 25, 30, 94, 174, CAN/CSA-E60079-0, 1, 7, ANSI/UL 514B Ed 5, ANSI/UL 50 Ed 11, ANSI/UL 2225 Ed 4, UL60079-0, 1, 7
UL Certificate (20S16 - 90)	E200163
Code of Protection	Class I, Zone 1, AEx e II
Compliance Standards	UL514B
EAC Certificate	TC RU C-GB.ГБ05.В00138
NEPSI Certificate	GY13.1141X / GY13.1283X
CCOE / PESO (India) Certificate	P333688
INMETRO Certificate	TUV 11.0374X
RETIE Certificate	03866
Marine Certificates	LRS: 01/00172 (E3), DNV: E-13848, ABS: 14-LD234401A-4-PDA
Ingress Protection Rating**	IP66, IP67 & IP68***
Deluge Protection Compliance	DTS01 : 91
NEMA Rating**	NEMA 4X
Cable Gland Material	Electroless Nickel Plated Brass, Copper Free (<0.4%) Aluminum, Stainless Steel
Seal Material	CMP SOLO LSF Halogen Free Thermoset Elastomer
Cable Type(s)	Steel / Served Wire Armor (SWA), Aluminum Wire Armor (AWA), Pliable Wire Armor (PWA), Steel Tape Armor (STA), Aluminum Strip Armor (ASA), Screened Flexible (EMC) Wire Braid (e.g. CY/SY), Wire Braid Armor (e.g. SWB)
Armor Clamping	Reversible Armor Cone & AnyWay Universal Clamping Ring
Sealing Technique	Inner Bedding Sealing Ring: Compensating Displacement Seal (CDS), Outer Sheath Sealing Ring: Load Retention Seal (LRS)
Sealing Area(s)	Cable Inner Bedding & Outer Cable Sheath

Cable Gland Selection Table

Refer to illustration at the top of the page

* Mechanical & Electrical Classifications applied as per IEC 62444 & EN 62444

** When NPT installation accessories are used. Refer to page 7 or www.cmp-products.com for further information.

*** IP68 tested to a minimum depth of 30 metres for 12 hours, alternate depths / durations can be provided upon request

Cable Gland Size	Available Entry Threads "C"			Minimum Thread Length "E"	Cable Bedding Diameter "A"		Overall Cable Diameter "B"		Armor Range †				Across Flats "D"	Across Corners "D"	Protrusion Length "F"	Combined Ordering Reference (*Nickel Plated Brass NPT)			Shroud	Cable Gland Weight (Ozs)
	NPT	NPT (Option)	Metric (Option)		Min	Max	Min	Max	Grooved Cone (X)		Stepped Cone (W)					Size	Type	Ordering Suffix		
									Min	Max	Min	Max								
20S16	1/2"	3/4"	M20	0.78	0.12	0.34	0.24	0.52	0.01	0.04	0.03	0.05	0.95	1.04	3.10	20S16	T3CDS	1RA531	PVC36	7.06
20S	1/2"	3/4"	M20	0.78	0.24	0.46	0.37	0.63	0.01	0.04	0.03	0.05	0.95	1.04	3.10	20S	T3CDS	1RA531	PVC36	6.91
20	1/2"	3/4"	M20	0.78	0.26	0.55	0.49	0.82	0.02	0.04	0.03	0.05	1.20	1.32	3.00	20	T3CDS	1RA531	PVC06	9.77
25S	3/4"	1"	M25	0.80	0.44	0.78	0.55	0.87	0.02	0.05	0.05	0.06	1.48	1.62	3.49	25S	T3CDS	1RA532	PVC09	15.34
25	3/4"	1"	M25	0.80	0.44	0.78	0.72	1.03	0.02	0.05	0.05	0.06	1.48	1.62	3.49	25	T3CDS	1RA532	PVC09	15.34
32	1"	1 1/4"	M32	0.98	0.67	1.03	0.93	1.34	0.02	0.05	0.06	0.08	1.81	1.99	3.57	32	T3CDS	1RA533	PVC11	22.33
40	1 1/4"	1 1/2"	M40	1.01	0.87	1.26	1.10	1.59	0.02	0.06	0.06	0.08	2.17	2.38	3.67	40	T3CDS	1RA534	PVC15	31.92
50S	1 1/2"	2"	M50	1.03	1.16	1.50	1.39	1.84	0.02	0.06	0.08	0.10	2.36	2.60	3.96	50S	T3CDS	1RA535	PVC18	39.65
50	2"	2 1/2"	M50	1.06	1.40	1.73	1.59	2.09	0.02	0.06	0.08	0.10	2.76	3.04	4.16	50	T3CDS	1RA536	PVC21	56.58
63S	2"	2 1/2"	M63	1.06	1.58	1.97	1.80	2.34	0.02	0.06	0.08	0.10	2.95	3.24	4.03	63S	T3CDS	1RA536	PVC23	61.10
63	2 1/2"	3"	M63	1.57	1.86	2.20	2.15	2.59	0.02	0.06	0.08	0.10	3.15	3.47	4.15	63	T3CDS	1RA537	PVC25	62.72
75S	2 1/2"	3"	M75	1.57	2.08	2.44	2.32	2.84	0.02	0.06	0.08	0.10	3.54	3.90	4.35	75S	T3CDS	1RA537	PVC28	90.70
75	3"	3 1/2"	M75	1.63	2.33	2.67	2.63	3.09	0.02	0.06	0.10	0.12	3.94	4.33	4.73	75	T3CDS	1RA538	PVC30	117.93
90	3 1/2"	4"	M90	1.69	2.62	3.09	3.00	3.56	0.03	0.06	0.12	0.16	4.53	4.98	5.47	90	T3CDS	1RA539	PVC32	171.73
100	3 1/2"	4"	M100	1.69	2.99	3.58	3.39	3.99	0.03	0.06	0.12	0.16	5.00	5.50	6.05	100	T3CDS	1RA539	LSF33	175.28
115	4"	5"	M115	1.73	3.39	3.85	4.00	4.34	0.03	0.06	0.12	0.16	5.43	5.98	6.50	115	T3CDS	1RA5310	LSF34	272.35
130	5"	-	M130	1.84	3.82	4.52	4.34	4.85	0.03	0.06	0.12	0.16	6.00	6.80	6.82	130	T3CDS	1RA5311	LSF35	344.37

*Note : For material options please change the suffix in the Ordering Reference : Brass (no suffix required), Nickel Plated Brass "5" (as standard), 316 Grade Stainless Steel "4", Copper Free Aluminum "1"

For NPT options please change the following digits after the material suffix ; 1/2" = 31, 3/4" = 32, 1" = 33, 1 1/4" = 34, 1 1/2" = 35, 2" = 36, 2 1/2" = 37, 3" = 38, 3 1/2" = 39, 4" = 310 (Brass requires prefix "0")

Examples: 32T3CDS1RA533534 = Nickel Plated Brass 1 1/4" NPT, 50S13CDS1RA536035 = Brass 1 1/2" NPT, 25T3CDS1RA532432 = Stainless Steel 3/4" NPT, 20T3CDS1RA5315 = Nickel Plated Brass M20

Dimensions are displayed in inches unless otherwise stated

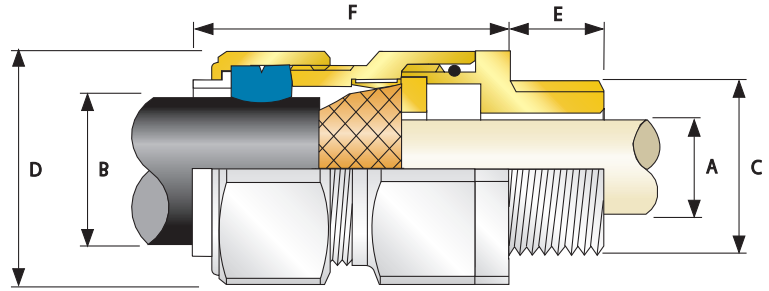

C2KX



C2KX Globally Approved, Hazardous (Classified) Location Cable Gland

For all types of Braided cables

- Metal-to-metal armor clamping
- Direct & remote installation
- Integral protected deluge seal
- Controlled outer 'load retention' seal
- Unique OSTG prevents overtightening
- Integral protected deluge seal
- -76°F to 266°F (standard), -4°F to 392°F (ThermEx option)
- Globally marked, UL, cCSAus, IECEx & ATEX
- Superior EMC performance
- VAR design available for VFD/VSD cables
- As standard in nickel plated brass with NPT thread form



CMP SOLO LSF Halogen Free Shrouds also available on request.

TECHNICAL DATA	
Design Specification	BS 6121:Part 1:1989, IEC 62444, EN 62444
Mechanical Classifications*	Impact = Level 8, Cable Anchorage = Class D
Enclosure Protection	IK10 to IEC 62262 (20 joules) Brass & Stainless Steel only
Electrical Classifications*	Category B (Category A when used with braid, tape or pliable wire armor cables)
ATEX Certificate	SIRA13ATEX1070X, SIRA13ATEX4076X
Code of Protection	⊕ II 2G, II 1D, Ex e IIC Gb, Ex ta IIIC Da ⊕ II 3G Ex nR IIC Gc
Compliance Standards	EN 60079-0,7,15,31
IECEx Certificate	IECEx SIR 13.0025X
Code of Protection	Ex e IIC Gb, Ex ta IIIC Da
Compliance Standards	IEC 612410,7,15, 31
cCSAus Certificate (20S16 - 90)	2367109
CSAus Code of Protection	Class I, Zone 1, AEx e II, AEx nR II
cCSA Code of Protection	Ex e II, Ex nR II
Compliance Standards	CAN/CSA-C22.2 No 0,18,3,94,1,94,2, CAN/CSA-E60079-0,7, ANSI/UL 514B, 5th Ed, ANSI/UL 50, ANSI/UL 50E, ANSI/UL 2225, 4th Ed, CAN/CSA C22.2 No. 60529:05, ANSI/UL 60079-0, 5th Ed, ANSI/UL 60079-7, 4th Ed, IEC 60529 Ed. 2.1
UL Certificate (20S16 - 90)	E 200163, E256367
EAC Certificate	TC RU C-GB.F605.B00138
CCOE / PESO (India) Certificate	P333688
NEPSI Certificate	GY13.1140X
INMETRO Approval	TÜV 120617X
RETIE Approval Number	03866
Marine Approvals	LRS: 01/00172 (E3) DNV: E-13848 ABS: 01LD234401B-2PPDA
Ingress Protection Rating**	IP66, IP67 & IP68***
Deluge Protection Compliance	DTS01 : 91
NEMA Rating**	NEMA 4X
Cable Gland Material	Electroless Nickel Plated Brass, Copper Free (<0.4%) Aluminum, Stainless Steel
Seal Material	CMP SOLO LSF Halogen Free Thermoset Elastomer
Cable Type	Braid Armored Shipboard cable and all IEC Braid Cables
Armor Clamping	Detachable Armor Cone & AnyWay Universal Clamping Ring
Sealing Technique	Unique CMP 'LRS' Outer Seal (Load Retention Seal)
Sealing Area(s)	Cable Outer Jacket

Cable Gland Selection Table
Refer to illustration at the top of the page

Cable Gland Size	Available Entry Threads "C"			Minimum Thread Length "E"	Cable Bedding Diameter "A"	Overall Cable Diameter "B"		Armor Range † Grooved Cone (X)		Across Flats "D"	Across Corners "D"	Protrusion Length "F"	Ordering Reference (*Nickel Plated Brass NPT)			Shroud	Cable Gland Weight (Ozs)
	NPT	NPT (Option)	Metric (Option)			Max	Min	Max	Min				Max	Max	Max		
20S16	1/2"	3/4"	M20	0.78	0.34	0.24	0.52	0.01	0.04	1.20	1.32	2.56	20S16	C2KX	1RA531	PVC06	8.19
20S	1/2"	3/4"	M20	0.78	0.46	0.37	0.63	0.01	0.04	1.20	1.32	2.44	20S	C2KX	1RA531	PVC06	7.96
20	1/2"	3/4"	M20	0.78	0.55	0.49	0.82	0.02	0.04	1.20	1.32	2.48	20	C2KX	1RA531	PVC06	7.86
25S	3/4"	1"	M25	0.80	0.79	0.55	0.87	0.02	0.05	1.48	1.62	2.74	25S	C2KX	1RA532	PVC09	12.24
25	3/4"	1"	M25	0.80	0.79	0.72	1.03	0.02	0.05	1.48	1.62	2.74	25	C2KX	1RA532	PVC09	12.24
32	1"	1 1/4"	M32	0.98	1.02	0.93	1.34	0.02	0.05	1.81	1.99	2.95	32	C2KX	1RA533	PVC11	19.47
40	1 1/4"	1 1/2"	M40	1.01	1.27	1.10	1.59	0.02	0.06	2.17	2.38	2.95	40	C2KX	1RA534	PVC15	26.46
50S	1 1/2"	2"	M50	1.03	1.50	1.39	1.84	0.02	0.06	2.36	2.60	3.03	50S	C2KX	1RA535	PVC18	30.27
50	2"	2 1/2"	M50	1.06	1.74	1.59	2.09	0.02	0.06	2.76	3.04	3.03	50	C2KX	1RA536	PVC21	40.00
63S	2"	2 1/2"	M63	1.06	1.97	1.80	2.34	0.02	0.06	2.95	3.25	3.15	63S	C2KX	1RA536	PVC23	46.77
63	2 1/2"	3"	M63	1.57	2.21	2.15	2.59	0.02	0.06	3.15	3.47	3.15	63	C2KX	1RA537	PVC25	47.37
75S	2 1/2"	3"	M75	1.57	2.44	2.32	2.84	0.02	0.06	3.54	3.90	3.43	75S	C2KX	1RA537	PVC28	71.39
75	3"	3 1/2"	M75	1.63	2.53	2.63	3.09	0.02	0.06	3.94	4.33	3.47	75	C2KX	1RA538	PVC30	87.41
90	3 1/2"	4"	M90	1.69	3.09	3.00	3.56	0.03	0.06	4.53	4.98	4.02	90	C2KX	1RA539	PVC32	124.27
100	3 1/2"	4"	M100	1.69	3.58	3.39	3.99	0.03	0.06	4.84	5.50	4.49	100	C2KX	1RA539	LSF33	101.13

*Note : For material options please change the suffix in the Ordering Reference ; Brass (no suffix required), Nickel Plated Brass "5" (as standard), 316 Grade Stainless Steel "4", Copper Free Aluminum "1" For NPT options please change the following digits after the material suffix ; 1/2" = 31, 3/4" = 32, 1" = 33, 1 1/4" = 34, 1 1/2" = 35, 2" = 36, 2 1/2" = 37, 3" = 38, 3 1/2" = 39, 4" = 310 (Brass requires prefix "0")

Examples: 32C2KX1RA5 = Nickel Plated Brass 32mm, 32C2KX1RA1 = Copper Free Aluminum 32mm

Dimensions are displayed in inches unless otherwise stated



PX2KX



PX2KX Globally Approved, Hazardous (Classified) Location Barrier Cable Gland

For all types of Braided & Tape Armored Cables

- Metal-to-metal armor clamping
- Direct & remote installation
- Integral protected deluge seal
- Compound barrier type flameproof seal
- Controlled outer 'load retention' seal
- Unique OSTG prevents overtightening
- Integral protected deluge seal
- Disconnectable, union feature design
- -76°F to 185°F
- Globally marked, UL, cCSAus, IECEx & ATEX
- Superior EMC performance
- As standard in nickel plated brass with NPT thread form



† Grooved Cone (X) is predominantly used for Wire Braid (e.g. GSWB, TCWB), Steel Tape Armor (STA, DSTA) and Aluminum Strip Armor (ASA) but is also suitable for Single Wire Armor (SWA), Aluminum Wire Armor (AWA) and Pliable Wire Armor (PWA) if the range is outside that of the Stepped Cone (W).

Grooved Cone (X) dimensions shown in the Cable Gland Selection Table below are for a double wire strand of braid armor cables. Tapes can also be doubled over. For cables that have only a single layer of armor such as SWA the clamping range should be used as shown in the table below.

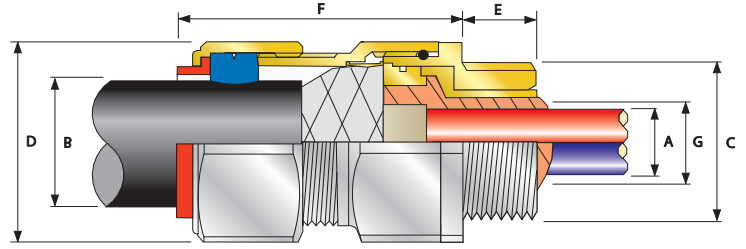

TECHNICAL DATA	
Design Specification	BS 6121:Part 1:1989, IEC 62444, EN 62444
Mechanical Classifications*	Impact = Level 8, Cable Anchorage = Class B
Enclosure Protection	IK10 to IEC 62262 (20 joules) Brass & Stainless Steel only
Electrical Classifications*	Category B (Category A when used with braid, tape or pliable wire armor cables)
ATEX Certificate	SIRA13ATEX1072X, SIRA13ATEX4078X
Code of Protection	Ⓜ II 2G, II 1D, Ex d IIC Gb, Ex e IIC Gb, Ex ta IIIC Da, Ⓜ II 3G Ex nR IIC Gc, Ⓜ IM2 Ex d I Mb, Ex e I Mb
Compliance Standards	EN 60079-0,1,7,15,31
IECEx Certificate	IECEx SIR 13.0027X
Code of Protection	Ex d IIC Gb, Ex e IIC Gb, Ex nR IIC Gc, Ex ta IIIC Da, Ex d I, Ex e I
Compliance Standards	IEC 60079-0,1,7,15,31
cCSAus Certificate (20S16 - 90)	2288626
CSAus Code of Protection***	Class I, Div. 1, 2 Groups A, B, C and D; Class II, Div. 1, 2 Groups E, F and G; Class III, Div. 1, 2; Type 4X: Oil Resistant II: Class I, Zone 1 AEx d IIC Gb, AEx e IIC Gb, Class I, Zone 2 AEx nR IIC Gc, Class I, Zone 20 AEx ta IIIC Da
cCSA Code of Protection***	Class I, Div. 1, 2 Groups A, B, C and D; Class II, Div. 1, 2 Groups E, F and G; Class III, Div. 1, 2; Type 4X: Oil Resistant II: Ex d IIC Gb, Ex e IIC Gb, Ex nR IIC Gc, Ex ta IIIC Da
Compliance Standards	CAN/CSA-C22.2 No 0,18,25,30,94,174, CAN/CSA-E60079-0,1,7,15,31 CAN/CSA-E6124111 Part 11, ANSI/UL 514B Ed 5, ANSI/UL 50 Ed 11, ANSI/UL 2225 Ed 4, UL60079
UL Certificate (20S16 - 90)	E201187, E161256C
Code of Protection	Class I Div 1,2, Groups A,B,C,D, Class II Div 1,2, Groups E,F,G
Compliance Standards	UL 2225, CSA C22.2 No 174, UK 514B, CSA C22.2 No 18, CSA C22.2 No 30
EAC Certificate	TC RU C-GB.ГБ05.В00138
CCOE / PESO (India) Certificate	P333688
NEPSI Certificate	GYJ13.1140X / GYJ13.1282X
INMETRO Approval	TUV 12.2073X
RETIE Approval Number	03866
Marine Approvals	LR5: 01/00172 (E3) DNV: E-13848 ABS: 14-LD234401A-4-PDA
Ingress Protection Rating**	IP66, IP67 & IP68****
Deluge Protection Compliance	DTS01 : 91
NEMA Rating**	NEMA 4X
Cable Gland Material	Electroless Nickel Plated Brass, Copper Free (<0.4%) Aluminum, Stainless Steel
Seal Material	CMP SOLO LSF Halogen Free Thermoset Elastomer / Epoxy Barrier Compound
Cable Type	Braid Armored Shipboard cable and all IEC Braid Cables***
Armor Clamping	Detachable Compound Tube / Cone & AnyWay Universal Clamping Ring
Sealing Technique	Unique CMP "LRS" Outer Seal (Load Retention Seal)
Sealing Area(s)	Inner Compound Barrier & Outer Sheath

* Mechanical & Electrical Classifications applied as per IEC 62444 & EN 62444
 ** When CMP installation accessories are used. Refer to page 7 or www.cmp-products.com for further information.
 *** Where the cable is permitted by code (NEC and/or CEC)
 **** IP68 tested to a minimum depth of 30 metres for 12 hours, alternate depths / durations can be provided upon request

Cable Gland Selection Table
 Refer to illustration at the top of the page.

Cable Gland Size	Available Entry Threads "C" (Alternative Metric Thread Lengths Available)				Number of Cores	Diameter Over Conductors "A"	Cable Bedding Diameter "G"	Overall Cable Diameter "B"		Armor Range † Grooved Cone (X)		Across Flats "D"	Across Corners "D"	Protrusion Length "F"	Combined Ordering Reference (*Nickel Plated Brass NPT)			Shroud	Cable Gland Weight (Ozs)
	NPT	NPT (Option)	Metric (Option)	Thread Length (NPT) "E"				Min	Max	Min	Max				Size	Type	Ordering Suffix		
20S16	1/2"	3/4"	M20	0.78	11	0.46	0.46	0.24	0.52	0.01	0.04	1.20	1.32	2.44	20S16	PX2KX	1RA531	PVC06	8.47
20S	1/2"	3/4"	M20	0.78	11	0.46	0.46	0.37	0.63	0.01	0.04	1.20	1.32	2.44	20S	PX2KX	1RA531	PVC06	8.11
20	1/2"	3/4"	M20	0.78	11	0.50	0.51	0.49	0.82	0.02	0.04	1.20	1.32	2.48	20	PX2KX	1RA531	PVC06	8.47
25S	3/4"	1"	M25	0.80	21	0.69	0.70	0.55	0.87	0.02	0.05	1.48	1.62	2.74	25S	PX2KX	1RA532	PVC09	13.05
25	3/4"	1"	M25	0.80	21	0.69	0.70	0.72	1.03	0.02	0.05	1.48	1.62	2.74	25	PX2KX	1RA532	PVC09	13.05
32	1"	1 1/4"	M32	0.98	38	0.93	0.94	0.93	1.34	0.02	0.05	1.81	1.99	2.95	32	PX2KX	1RA533	PVC11	20.11
40	1 1/4"	1 1/2"	M40	1.01	59	1.18	1.19	1.10	1.59	0.02	0.06	2.17	2.38	2.95	40	PX2KX	1RA534	PVC15	28.22
50S	1 1/2"	2"	M50	1.03	89	1.44	1.45	1.39	1.84	0.02	0.06	2.36	2.60	3.03	50S	PX2KX	1RA535	PVC18	31.75
50	2"	2 1/2"	M50	1.06	89	1.61	1.63	1.59	2.09	0.02	0.06	2.76	3.03	3.03	50	PX2KX	1RA536	PVC21	41.98
63S	2"	2 1/2"	M63	1.06	115	1.89	1.91	1.80	2.34	0.02	0.06	2.95	3.25	3.14	63S	PX2KX	1RA536	PVC23	49.03
63	2 1/2"	3"	M63	1.57	115	2.11	2.13	2.15	2.59	0.02	0.06	3.15	3.47	3.16	63	PX2KX	1RA537	PVC25	49.74
75S	2 1/2"	3"	M75	1.57	140	2.36	2.37	2.32	2.84	0.02	0.06	3.54	3.90	3.42	75S	PX2KX	1RA537	PVC28	73.72
75	3"	3 1/2"	M75	1.63	140	2.53	2.53	2.63	3.09	0.02	0.06	3.94	4.33	3.48	75	PX2KX	1RA538	PVC30	89.60
90	3 1/2"	4"	M90	1.69	200	2.97	2.98	3.00	3.56	0.03	0.06	4.53	4.98	4.02	90	PX2KX	1RA539	PVC32	130.87
100	3 1/2"	4"	M100	1.73	200	3.37	3.38	3.39	3.99	0.03	0.06	5.00	5.50	4.49	100	PX2KX	1RA5310	LSF33	169.67

*Note : For material options please change the suffix in the Ordering Reference ; Brass (no suffix required), Nickel Plated Brass "S" (as standard), 316 Grade Stainless Steel "4", Copper Free Aluminum "1" For NPT options please change the following digits after the material suffix ; 1/2" = 31, 3/4" = 32, 1" = 33, 1 1/4" = 34, 1 1/2" = 35, 2" = 36, 2 1/2" = 37, 3" = 38, 3 1/2" = 39, 4" = 310 (Brass requires prefix "0")

Examples: 32PX2KX1RA534 = Nickel Plated Brass 1 1/4" NPT, 50SPX2KX1RA035 = Brass 1 1/2" NPT, 25PX2KX1RA432 = Stainless Steel 3/4" NPT, 20PX2KX1RA5 Nickel Plated Brass M20

Dimensions are displayed in inches unless otherwise stated

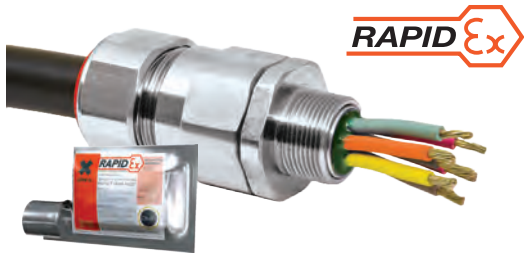

RAPID Ex

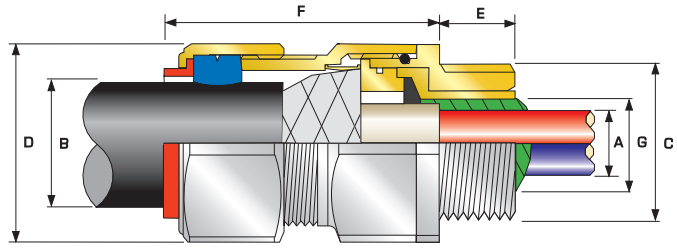

PX2KXREX



PX2KXREX Globally Approved, Hazardous (Classified) Location Barrier Cable Gland

For all types of Braided & Tape Armored Cables

- RapidEx liquid pour sealing system
 - Enhances reliability, reduces risk
 - Reduces man hours
 - Reduces cost
- Metal-to-metal armor clamping
- Direct & remote installation
- Integral protected deluge seal
- Disconnectable, union feature design
- Controlled outer 'load retention' seal
- Unique OSTG prevents overtightening
- -76°F to 185°F
- Globally marked, cCSAus, IECEx & ATEX
- Superior EMC performance
- As standard in nickel plated brass with NPT thread form

TECHNICAL DATA	
Design Specification	BS 6121:Part 1:1989, IEC 62444, EN 62444
Mechanical Classifications*	Impact = Level 8, Cable Anchorage = Class D
Enclosure Protection	IK10 to IEC 62262 (20 joules) Brass & Stainless Steel only
Electrical Classifications*	Category B (Category A when used with braid, tape or pliable wire armor cables)
ATEX Certificate	SIRA13ATEX1072X, SIRA13ATEX4078X
Code of Protection	Ⓜ II 2G, II 1D, Ex d IIC, Ex e IIC Gb, Ex ta IIIC Da Ⓜ II 3G Ex nR IIC Gc, Ⓜ IM2 Ex d I Mb, Ex e I Mb
Compliance Standards	EN 60079-0,1,7,15,31
IECEx Certificate	IECEx SIR 13.0027X
Code of Protection	Ex d IIC Gb, Ex e IIC Gb, Ex nR IIC Gc, Ex ta IIIC Da, Ex d I Mb, Ex e I Mb
Compliance Standards	IEC 60079-0,1,7,15,31
cCSAus Certificate (20S16 - 90)	2288626
CSAus Code of Protection***	Class I, Div. 1, 2 Groups A, B, C and D; Class II, Div. 1, 2 Groups E, F and G; Class III, Div. 1, 2; Type 4X: Oil Resistant II: Class I, Zone 1 AEx d IIC Gb, AEx e IIC Gb, Class I, Zone 2 AEx nR IIC Gc, Class I, Zone 20 AEx ta IIIC Da
cCSA Code of Protection***	Class I, Div. 1, 2 Groups A, B, C and D; Class II, Div. 1, 2 Groups E, F and G; Class III, Div. 1, 2; Type 4X: Oil Resistant II: Ex d IIC Gb, Ex e IIC Gb, Ex nR IIC Gc, Ex ta IIIC Da
Compliance Standards	CAN/CSA-C22.2 No 0,18,25,30,94,174, CAN/CSA-E60079-0,1,7,31 CAN/CSA-E6124111 Part 11, ANSI/UL 514B Ed 5, ANSI/UL 50 Ed 11, ANSI/UL 2225 Ed 4, UL60079
EAC Certificate	TC RU C-GB.T605.B00138
CCOE / PESO (India) Certificate	P333688
NEPSI Certificate	GYJ13.1140X / GYJ13.1282X
INMETRO Approval	TÜV 12.2073X
RETIE Approval Number	03866
Marine Approvals	LRS: 01/00172 (E3) DNV: E-13848 ABS: 14-LD234401A-4-PDA
Ingress Protection Rating**	IP66, IP67 & IP68****
Deluge Protection Compliance	DTS01 : 91
NEMA Rating**	NEMA 4X
Cable Gland Material	Electroless Nickel Plated Brass, Copper Free (<0.4%) Aluminum, Stainless Steel
Seal Material	CMP SOLO LSF Halogen Free Thermoset Elastomer / RapidEx Resin Barrier
Cable Type	Braid Armored Shipboard cable and all IEC Braid Cables***
Armor Clamping	Detachable Resin Tube / Cone & AnyWay Universal Clamping Ring
Sealing Technique	Unique CMP 'LRS' Outer Seal (Load Retention Seal)
Sealing Area(s)	Inner RapidEx Barrier Seal & Outer Sheath



† Grooved Cone (X) is predominantly used for Wire Braid (e.g. GSWB, TCWB), Steel Tape Armor (STA, DSTA) and Aluminum Strip Armor (ASA) but is also suitable for Single Wire Armor (SWA), Aluminum Wire Armor (AWA) and Pliable Wire Armor (PWA) if the range is outside that of the Stepped Cone (W).

Grooved Cone (X) dimensions shown in the Cable Gland Selection Table below are for a double wire strand of braid armor cables. Tapes can also be doubled over. For cables that have only a single layer of armor such as SWA the clamping range should be used as shown in the table below.

Supplied in pack with RapidEx resin

* Mechanical & Electrical Classifications applied as per IEC 62444 & EN 62444
 ** When CMP installation accessories are used. Refer to page 7 or www.cmp-products.com for further information.
 *** Where the cable is permitted by code (NEC and/or CEC)
 **** IP68 tested to a minimum depth of 30 metres for 12 hours, alternate depths / durations can be provided upon request

Cable Gland Selection Table
 Refer to illustration at the top of the page.

Cable Gland Size	Available Entry Threads "C" (Alternative Metric Thread Lengths Available)				Number of Cores	Diameter Over Conductors "A"	Cable Bedding Diameter "G"	Overall Cable Diameter "B"		Armor Range † Grooved Cone (X)		Across Flats "D"		Across Corners "D"	Protrusion Length "F"	Combined Ordering Reference (*Nickel Plated Brass NPT)			Shroud	Cable Gland Weight (Ozs)
	NPT	NPT (Option)	Metric (Option)	Thread Length (NPT) "E"				Max	Min	Max	Min	Max	Max			Max	Size	Type		
20S16	1/2"	3/4"	M20	0.78	11	0.46	0.46	0.24	0.52	0.01	0.04	1.20	1.32	2.44	20S16	PX2KXREX	1EX531	PVC06	8.47	
20S	1/2"	3/4"	M20	0.78	11	0.46	0.46	0.37	0.63	0.01	0.04	1.20	1.32	2.44	20S	PX2KXREX	1EX531	PVC06	8.11	
20	1/2"	3/4"	M20	0.78	11	0.50	0.51	0.49	0.82	0.02	0.04	1.20	1.32	2.48	20	PX2KXREX	1EX531	PVC06	8.47	
25S	3/4"	1"	M25	0.80	21	0.69	0.70	0.55	0.87	0.02	0.05	1.48	1.62	2.74	25S	PX2KXREX	1EX532	PVC09	13.05	
25	3/4"	1"	M25	0.80	21	0.69	0.70	0.72	1.03	0.02	0.05	1.48	1.62	2.74	25	PX2KXREX	1EX532	PVC09	13.05	
32	1"	1 1/4"	M32	0.98	38	0.93	0.94	0.93	1.34	0.02	0.05	1.81	1.99	2.95	32	PX2KXREX	1EX533	PVC11	20.11	
40	1 1/4"	1 1/2"	M40	1.01	59	1.18	1.19	1.10	1.59	0.02	0.06	2.17	2.38	2.95	40	PX2KXREX	1EX534	PVC15	28.22	
50S	1 1/2"	2"	M50	1.03	89	1.44	1.45	1.39	1.84	0.02	0.06	2.36	2.60	3.03	50S	PX2KXREX	1EX535	PVC18	31.75	
50	2"	2 1/2"	M50	1.06	89	1.61	1.63	1.59	2.09	0.02	0.06	2.76	3.03	3.03	50	PX2KXREX	1EX536	PVC21	41.98	
63S	2 1/2"	3"	M63	1.06	115	1.89	1.91	1.80	2.34	0.02	0.06	2.95	3.25	3.14	63S	PX2KXREX	1EX536	PVC23	49.03	
63	2 1/2"	3"	M63	1.57	115	2.11	2.13	2.15	2.59	0.02	0.06	3.15	3.47	3.16	63	PX2KXREX	1EX537	PVC25	49.74	
75S	2 1/2"	3"	M75	1.57	140	2.36	2.37	2.32	2.84	0.02	0.06	3.54	3.90	3.42	75S	PX2KXREX	1EX537	PVC28	73.72	
75	3"	3 1/2"	M75	1.63	140	2.53	2.53	2.63	3.09	0.02	0.06	3.94	4.33	3.48	75	PX2KXREX	1EX538	PVC30	89.60	
90	3 1/2"	4"	M90	1.69	200	2.97	2.98	3.00	3.56	0.03	0.06	4.53	4.98	4.02	90	PX2KXREX	1EX539	PVC32	130.87	
100	3 1/2"	4"	M100	1.73	200	3.37	3.38	3.39	3.99	0.03	0.06	5.00	5.50	4.49	100	PX2KXREX	1EX5310	LSF33	169.67	

* Note : For material options please change the suffix in the Ordering Reference ; Brass (no suffix required), Nickel Plated Brass "5" (as standard), 316 Grade Stainless Steel "4", Copper Free Aluminum "1"
 For NPT options please change the following digits after the material suffix ; 1/2" = 31, 3/4" = 32, 1" = 33, 1 1/4" = 34, 1 1/2" = 35, 2" = 36, 2 1/2" = 37, 3" = 38, 3 1/2" = 39, 4" = 310 (Brass requires prefix "0")
 Examples: 32PX2KXREX1RA534 = Nickel Plated Brass 1 1/4" NPT, 50SPX2KXREX1RA035 = Brass 1 1/2" NPT, 25PX2KXREX1RA432 = Stainless Steel 3/4" NPT, 20PX2KXREX1RA5 Nickel Plated Brass M20

Dimensions are displayed in inches unless otherwise stated

CMP PRODUCTS HAZARDOUS LOCATION CABLE GLANDS



PX2KW



PX2KW Globally Approved, Hazardous (Classified) Location Barrier Cable Gland

For all types of Single / Served Wire Armored Cables

- Metal-to-metal armor clamping
- Direct & remote installation
- Integral protected deluge seal
- Compound barrier type flameproof seal
- Controlled outer 'load retention' seal
- Unique OSTG prevents overtightening
- Integral protected deluge seal
- Disconnectable, union feature design
- -76°F to 185°F
- Globally marked, UL, cCSAus, IECEx & ATEX
- Superior EMC performance
- As standard in nickel plated brass with NPT thread form

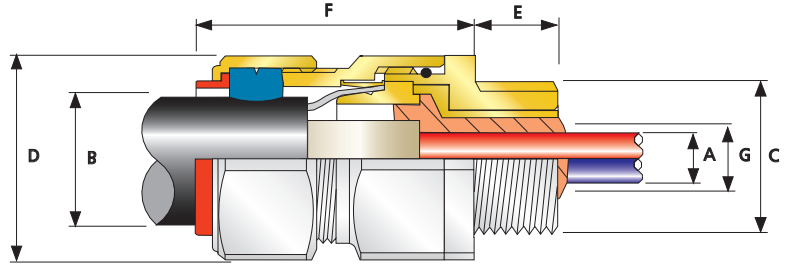

TECHNICAL DATA	
Design Specification	BS 6121:Part 1:1989, IEC 62444, EN 62444
Mechanical Classifications*	Impact = Level 8, Cable Anchorage = Class B
Enclosure Protection	IK10 to IEC 62262 (20 joules) Brass & Stainless Steel only
Electrical Classifications*	Category B (Category A when used with braid, tape or pliable wire armor cables)
ATEX Certificate	SIRA13ATEX1072X, SIRA13ATEX4078X
Code of Protection	Ⓜ II 2G, II 1D, Ex d IIC Gb, Ex e IIC Gb, Ex ta IIIC Da, Ⓜ II 3G Ex nR IIC Gc, Ⓜ II M2 Ex d I Mb, Ex e I Mb
Compliance Standards	EN 60079-0,1,7,15,31
IECEx Certificate	IECEx SIR 13.0027X
Code of Protection	Ex d IIC Gb, Ex e IIC Gb, Ex nR IIC Gc, Ex ta IIIC Da, Ex d I, Ex e I
Compliance Standards	IEC 60079-0,1,7,15,31
cCSAus Certificate (20S16 - 90)	2288626
CSAus Code of Protection***	Class I, Div. 1, 2 Groups A, B, C and D; Class II, Div. 1, 2 Groups E, F and G; Class III, Div. 1, 2; Type 4X; Oil Resistant II: Class I, Zone 1 AEx d IIC Gb, AEx e IIC Gb, Class I, Zone 2 AEx nR IIC Gc, Class I, Zone 20 AEx ta IIIC Da
cCSA Code of Protection***	Class I, Div. 2 Groups A, B, C and D; Class II, Div. 2 Groups F and G; Class III, Div. 2; Type 4X; Oil Resistant II: Ex d IIC Gb, Ex e IIC Gb, Ex nR IIC Gc, Ex ta IIIC Da
Compliance Standards	CAN/CSA-C22.2 No 0,18,25,30,94,174, CAN/CSA-E60079-0,1,7,15,31 CAN/CSA-E6124111 Part 11, ANSI/UL 514B Ed 5, ANSI/UL 50 Ed 11, ANSI/UL 2225 Ed 4, UL60079
UL Certificate (20S16 - 90)	E201187, E161256C
Code of Protection	Class I Div 1,2, Groups A,B,C,D, Class II Div 1,2, Groups E,F,G
Compliance Standards	UL 2225, CSA C22.2 No 174, UK 514B, CSA C22.2 No 18, CSA C22.2 No 30
EAC Certificate	TC RU C-GB.Γ505.B00138
CCOE / PESO (India) Certificate	P333688
NEPSI Certificate	GYJ13.1140X / GYJ13.1282X
INMETRO Approval	TÜV 12.2073X
RETIE Approval Number	03866
Marine Approvals	LRS: 01/00172 (E3) DNV: E-13848 ABS: 14-LD234401A-4-PDA
Ingress Protection Rating**	IP66, IP67 & IP68****
Deluge Protection Compliance	DTS01 : 91
NEMA Rating**	NEMA 4X
Cable Gland Material	Electroless Nickel Plated Brass, Copper Free (<0.4%) Aluminum, Stainless Steel
Seal Material	CMP SOLO LSF Halogen Free Thermoset Elastomer / Epoxy Barrier Compound
Cable Type	Single / Served Wire Armor (SWA)***
Armor Clamping	Detachable Compound Tube / Cone & AnyWay Universal Clamping Ring
Sealing Technique	Unique CMP 'LRS' Outer Seal (Load Retention Seal)
Sealing Area(s)	Inner Compound Barrier & Outer Sheath

* Mechanical & Electrical Classifications applied as per IEC 62444 & EN 62444
 ** When CMP installation accessories are used. Refer to page 7 or www.cmp-products.com for further information.
 *** Where the cable is permitted by code (NEC and/or CEC)
 **** IP68 tested to a minimum depth of 30 metres for 12 hours, alternate depths / durations can be provided upon request

Cable Gland Selection Table

Refer to illustration at the top of the page.

Cable Gland Size	Available Entry Threads "C" (Alternative Metric Thread Lengths Available)				Number of Cores	Diameter Over Conductors "A"	Cable Bedding Diameter "G"	Overall Cable Diameter "B"			Armor Range †		Across Flats "D"	Across Corners "D"	Protrusion Length "F"	Combined Ordering Reference (*Nickel Plated Brass NPT)			Shroud	Cable Gland Weight (Ozs)
	NPT	NPT (Option)	Metric (Option)	Thread Length (NPT) "E"				Min	Max	Min	Max	Min				Max	Max	Max		
20S16	1/2"	3/4"	M20	0.78	11	0.46	0.46	0.24	0.52	0.03	0.05	1.20	1.32	2.44	20S16	PX2KW	1RA531	PVC06	8.47	
20S	1/2"	3/4"	M20	0.78	11	0.46	0.46	0.37	0.63	0.03	0.05	1.20	1.32	2.44	20S	PX2KW	1RA531	PVC06	8.11	
20	1/2"	3/4"	M20	0.78	11	0.50	0.51	0.49	0.82	0.03	0.05	1.20	1.32	2.48	20	PX2KW	1RA531	PVC06	8.47	
25S	3/4"	1"	M25	0.80	21	0.69	0.70	0.55	0.87	0.05	0.06	1.48	1.62	2.74	25S	PX2KW	1RA532	PVC09	13.05	
25	3/4"	1"	M25	0.80	21	0.69	0.70	0.72	1.03	0.05	0.06	1.48	1.62	2.74	25	PX2KW	1RA532	PVC09	13.05	
32	1"	1 1/4"	M32	0.98	38	0.93	0.94	0.93	1.34	0.06	0.08	1.81	1.99	2.95	32	PX2KW	1RA533	PVC11	20.11	
40	1 1/4"	1 1/2"	M40	1.01	59	1.18	1.19	1.10	1.59	0.06	0.08	2.17	2.38	2.95	40	PX2KW	1RA534	PVC15	28.22	
50S	1 1/2"	2"	M50	1.03	89	1.44	1.45	1.39	1.84	0.08	0.10	2.36	2.60	3.03	50S	PX2KW	1RA535	PVC18	31.75	
50	2"	2 1/2"	M50	1.06	89	1.61	1.63	1.59	2.09	0.08	0.10	2.76	3.03	3.03	50	PX2KW	1RA536	PVC21	41.98	
63S	2"	2 1/2"	M63	1.06	115	1.89	1.91	1.80	2.34	0.08	0.10	2.95	3.25	3.14	63S	PX2KW	1RA536	PVC23	49.03	
63	2 1/2"	3"	M63	1.57	115	2.11	2.13	2.15	2.59	0.08	0.10	3.15	3.47	3.16	63	PX2KW	1RA537	PVC25	49.74	
75S	2 1/2"	3"	M75	1.57	140	2.36	2.37	2.32	2.84	0.08	0.10	3.54	3.90	3.42	75S	PX2KW	1RA537	PVC28	73.72	
75	3"	3 1/2"	M75	1.63	140	2.53	2.53	2.63	3.09	0.10	0.12	3.94	4.33	3.48	75	PX2KW	1RA538	PVC30	89.60	
90	3 1/2"	4"	M90	1.69	200	2.97	2.98	3.00	3.56	0.12	0.16	4.53	4.98	4.02	90	PX2KW	1RA539	PVC32	130.87	
100	3 1/2"	4"	M100	1.73	200	3.37	3.38	3.39	3.99	0.12	0.16	5.00	5.50	4.49	100	PX2KW	1RA5310	LSF33	169.67	

* Note : For material options please change the suffix in the Ordering Reference ; Brass (no suffix required), Nickel Plated Brass "5" (as standard), 316 Grade Stainless Steel "4", Copper Free Aluminum "1" For NPT options please change the following digits after the material suffix ; 1/2" = 31, 3/4" = 32, 1" = 33, 1 1/4" = 34, 1 1/2" = 35, 2" = 36, 2 1/2" = 37, 3" = 38, 3 1/2" = 39, 4" = 310 (Brass requires prefix "0")

Examples: 32PX2KW1RA534 = Nickel Plated Brass 1 1/4" NPT, 50SPX2KW1RA035 = Brass 1 1/2" NPT, 25PX2KW1RA432 = Stainless Steel 3/4" NPT, 20PX2KW1RA5 Nickel Plated Brass M20

Dimensions are displayed in inches unless otherwise stated

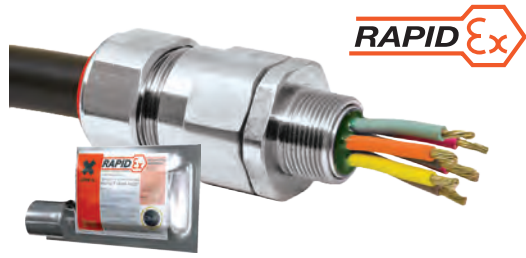

RAPIDEx

PX2KWREX



PX2KWREX Globally Approved, Hazardous (Classified) Location Barrier Cable Gland

For all types of Single / Served Wire Armored Cables

- RapidEx liquid pour sealing system
 - Enhances reliability, reduces risk
 - Reduces man hours
 - Reduces cost
- Metal-to-metal armor clamping
- Direct & remote installation
- Integral protected deluge seal
- Disconnectable, union feature design
- Controlled outer 'load retention' seal
- Unique OSTG prevents overtightening
- -76°F to 185°F
- Globally marked, cCSAus, IECEx & ATEX
- Superior EMC performance
- As standard in nickel plated brass with NPT thread form



Supplied in pack with RapidEx resin

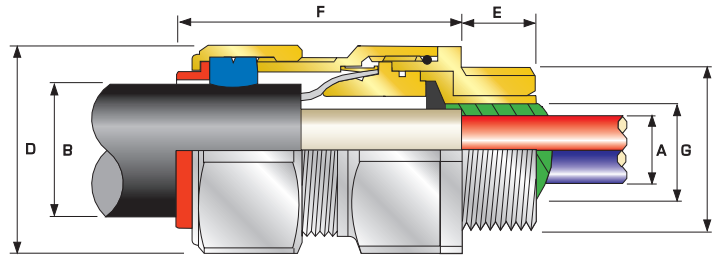

TECHNICAL DATA	
Design Specification	BS 6121:Part 1:1989, IEC 62444, EN 62444
Mechanical Classifications*	Impact = Level 8, Cable Anchorage = Class D
Enclosure Protection	IK10 to IEC 62262 (20 joules) Brass & Stainless Steel only
Electrical Classifications*	Category B (Category A when used with braid, tape or pliable wire armor cables)
ATEX Certificate	SIRA13ATEX1072X, SIRA13ATEX4078X
Code of Protection	Ⓜ II 2G, II 1D, Ex d IIC, Ex e IIC Gb, Ex ta IIIC Da Ⓜ II 3G Ex nR IIC Gc, Ⓜ IM2 Ex d I Mb, Ex e I Mb
Compliance Standards	EN 60079-0,1,7,15,31
IECEx Certificate	IECEx SIR 13.0027X
Code of Protection	Ex d IIC Gb, Ex e IIC Gb, Ex nR IIC Gc, Ex ta IIIC Da, Ex d I Mb, Ex e I Mb
Compliance Standards	IEC 60079-0,1,7,15,31
cCSAus Certificate (20S16 - 90)	2288626
CSAus Code of Protection***	Class I, Div. 1, 2 Groups A, B, C and D; Class II, Div. 1, 2 Groups E, F and G; Class III, Div. 1, 2; Type 4X; Oil Resistant II: Class I, Zone 1 AEx d IIC Gb, AEx e IIC Gb, Class I, Zone 2 AEx nR IIC Gc, Class I, Zone 20 AEx ta IIIC Da
cCSA Code of Protection***	Class I, Div. 2 Groups A, B, C and D; Class II, Div. 2 Groups F and G; Class III, Div. 2; Type 4X; Oil Resistant II: Ex d IIC Gb, Ex e IIC Gb, Ex nR IIC Gc, Ex ta IIIC Da
Compliance Standards	CAN/CSA-C22.2 No 0,18,25,30,94,174, CAN/CSA-E60079-0,1,7,31 CAN/CSA-E6124111 Part 11, ANSI/UL 514B Ed 5, ANSI/UL 50 Ed 11, ANSI/UL 2225 Ed 4, UL60079
EAC Certificate	TC RU C-GB.Г505.В00138
CCOE / PESO (India) Certificate	P333688
NEPSI Certificate	GY13.1140X / GY13.1282X
INMETRO Approval	TUV 12.2073X
RETIE Approval Number	03866
Marine Approvals	LRS: 01/00172 (E3) DNV: E-13848 ABS: 14-LD234401A-4-PDA
Ingress Protection Rating**	IP66, IP67 & IP68****
Deluge Protection Compliance	DTS01 : 91
NEMA Rating**	NEMA 4X
Cable Gland Material	Electroless Nickel Plated Brass, Copper Free (<0.4%) Aluminum, Stainless Steel
Seal Material	CMP SOLO LSF Halogen Free Thermoset Elastomer / RapidEx Resin Barrier
Cable Type	Single / Served Wire Armor (SWA)***
Armor Clamping	Detachable Resin Tube / Cone & AnyWay Universal Clamping Ring
Sealing Technique	Unique CMP 'LRS' Outer Seal (Load Retention Seal)
Sealing Area(s)	Inner RapidEx Barrier Seal & Outer Sheath

* Mechanical & Electrical Classifications applied as per IEC 62444 & EN 62444
 ** When CMP installation accessories are used. Refer to page 7 or www.cmp-products.com for further information.
 *** Where the cable is permitted by code (NEC and/or CEC)
 **** IP68 tested to a minimum depth of 30 metres for 12 hours, alternate depths / durations can be provided upon request

Cable Gland Selection Table

Refer to illustration at the top of the page.

Cable Gland Size	Available Entry Threads "C" (Alternative Metric Thread Lengths Available)				Number of Cores	Diameter Over Conductors "A"	Cable Bedding Diameter "C"	Overall Cable Diameter "B"		Armor Range †		Across Flats "D"	Across Corners "D"	Protrusion Length "F"	Combined Ordering Reference (*Nickel Plated Brass NPT)			Shroud	Cable Gland Weight (Ozs)
	NPT	NPT (Option)	Metric (Option)	Thread Length (NPT) "E"				Min	Max	Min	Max				Size	Type	Ordering Suffix		
20S16	1/2"	3/4"	M20	0.78	11	0.461	0.46	0.24	0.52	0.03	0.05	1.20	1.32	2.44	20S16	PX2KWREX	1EX531	PVC06	8.47
20S	1/2"	3/4"	M20	0.78	11	0.461	0.46	0.37	0.63	0.03	0.05	1.20	1.32	2.44	20S	PX2KWREX	1EX531	PVC06	8.11
20	1/2"	3/4"	M20	0.78	11	0.496	0.51	0.49	0.82	0.03	0.05	1.20	1.32	2.48	20	PX2KWREX	1EX531	PVC06	8.47
25S	3/4"	1"	M25	0.80	21	0.689	0.70	0.55	0.87	0.05	0.06	1.48	1.62	2.74	25S	PX2KWREX	1EX532	PVC09	13.05
25	3/4"	1"	M25	0.80	21	0.689	0.70	0.72	1.03	0.05	0.06	1.48	1.62	2.74	25	PX2KWREX	1EX532	PVC09	13.05
32	1"	1 1/4"	M32	0.98	38	0.929	0.94	0.93	1.34	0.06	0.08	1.81	1.99	2.95	32	PX2KWREX	1EX533	PVC11	20.11
40	1 1/4"	1 1/2"	M40	1.01	59	1.181	1.19	1.10	1.59	0.06	0.08	2.17	2.38	2.95	40	PX2KWREX	1EX534	PVC15	28.22
50S	1 1/2"	2"	M50	1.03	89	1.441	1.45	1.39	1.84	0.08	0.10	2.36	2.60	3.03	50S	PX2KWREX	1EX535	PVC18	31.75
50	2"	2 1/2"	M50	1.06	89	1.614	1.63	1.59	2.09	0.08	0.10	2.76	3.03	3.03	50	PX2KWREX	1EX536	PVC21	41.98
63S	2"	2 1/2"	M63	1.06	115	1.886	1.91	1.80	2.34	0.08	0.10	2.95	3.25	3.14	63S	PX2KWREX	1EX536	PVC23	49.03
63	2 1/2"	3"	M63	1.57	115	2.114	2.13	2.15	2.59	0.08	0.10	3.15	3.47	3.16	63	PX2KWREX	1EX537	PVC25	49.74
75S	2 1/2"	3"	M75	1.57	140	2.358	2.37	2.32	2.84	0.08	0.10	3.54	3.90	3.42	75S	PX2KWREX	1EX537	PVC28	73.72
75	3"	3 1/2"	M75	1.63	140	2.528	2.53	2.63	3.09	0.10	0.12	3.94	4.33	3.48	75	PX2KWREX	1EX538	PVC30	89.60
90	3 1/2"	4"	M90	1.69	200	2.965	2.98	3.00	3.56	0.12	0.16	4.53	4.98	4.02	90	PX2KWREX	1EX539	PVC32	130.87
100	3 1/2"	4"	M100	1.73	200	3.370	3.38	3.39	3.99	0.12	0.16	5.00	5.50	4.49	100	PX2KWREX	1EX5310	LSF33	169.67

*Note : For material options please change the suffix in the Ordering Reference ; Brass (no suffix required), Nickel Plated Brass "S" (as standard), 316 Grade Stainless Steel "4", Copper Free Aluminum "1" For NPT options please change the following digits after the material suffix ; 1/2" = 31, 3/4" = 32, 1" = 33, 1 1/4" = 34, 1 1/2" = 35, 2" = 36, 2 1/2" = 37, 3" = 38, 3 1/2" = 39, 4" = 310 (Brass requires prefix "0")
 Examples: 32PX2KWREX1RA534 = Nickel Plated Brass 1/4" NPT, 50SPX2KWREX1RA035 = Brass 1/2" NPT, 25PX2KWREX1RA432 = Stainless Steel 3/4" NPT, 20PX2KWREX1RA5 Nickel Plated Brass M20

Dimensions are displayed in inches unless otherwise stated





Thread Conversions & Accessories

The CMP range of Thread Conversion Adaptors, Reducers and associated products are available for use in Industrial, Marine and Explosive Atmosphere applications, and are particularly suited to construction projects where a high volume of cables are being installed.

When the Gland fits the cable but its connecting thread differs from that of the equipment the best solution may be to use a CMP thread conversion adaptor, especially when schedules are critical and time is of the essence.

CMP thread conversion adaptors and reducers offer the flexibility of allowing the job to progress by using a standard product to save time and ultimate cost compared with modifying hole sizes in equipment.

In addition to Thread Conversion Adaptors and Reducers, CMP Products also provides, Unions, Stopper Plugs, Breather / Drain Plugs and Insulated Adaptors. All products in this range are available in a variety of materials, both metallic and non-metallic, and can be supplied in a combination of different thread forms and sizes including Metric, PG, NPT, BSP etc.

All products comply with the latest IEC standards and are offered with certification from a host of internationally recognised bodies.



Ordering Thread Conversions & Accessories

To determine ordering reference please select from the tables below in the following order:

- Product Type
- Form of protection
- Thread Form
- Thread Size
- Thread Form (if applicable)
- Thread Size (if applicable)
- Material

When selecting and installing certified electrical equipment and components in potentially Explosive Atmospheres, it is the users responsibility to ensure that the local industry codes of practice are observed and followed, for example IEC 60079-14.

Below Example:

737DTR3T25

737 Adaptor - Globally Certified - 1/2" (M) x 3/4" (F) - Nickel Plated Brass

Product Type	Form of Protection	Option	Male Thread Form	Male Thread Size	Female Thread Form	Female Thread Size	Material
From Product Page	From Table A Below	From Table B Below	From Table C Below	From Table D Below	From Table C Below	From Table D Below	From Table E Below
737	D	B	M	3	M	2	5

Table A

Code	Form of Protection
D	Group II Globally Certified Ex d / AEx d & Ex e / AEx e
E	Group II Increased Safety Ex e / AEx e
G	General Purpose
M	Group I Mining

Table B

Code	Options
A	Type A - Externally secured non tamper-proof Ex d Stopper Plug or Type A - Insulated Adaptor*
B	Type B - Internally secured tamper-proof Ex d Stopper Plug or Type B - Insulated Adaptor*
R**	Optional equipment interface 'O' ring seal

Table C

Code	Thread Form
M	Metric
N	NPSM
T	NPT
P	PG
B	BSPP
I	Imperial (E.T.)
S	BSPT

Other variations available on request

Nominal dimensions shown in this catalog may vary due to material availability. All dimensions shown are in inches unless otherwise stated. Within the parameters of its Explosive Atmosphere certification, CMP Products reserves the right to change the design and/or dimensions of any of the products illustrated without notice. For further information please contact CMP Products.

**When ordered with the integral 'O' ring seal the across flats dimension shown may increase to accommodate the 'O' ring.

Table D

Code	Thread Size						
	Metric "M"	NPSM "N"	NPT "T"	PG "P"	BSPP "B"	Imperial (E.T.) "I"	BSPT "S"
1A	-	-	3/8"	7	-	1/2"	-
1	16	1/2"	1/2"	9	1/2"	5/8"	1/2"
2	20	3/4"	3/4"	11	3/4"	3/4"	3/4"
3	25	1"	1"	13.5	1"	1"	1"
4	32	1 1/4"	1 1/4"	16	1 1/4"	1 1/4"	1 1/4"
5	40	1 1/2"	1 1/2"	21	1 1/2"	1 1/2"	1 1/2"
6	50	2"	2"	29	2"	2"	2"
7	63	2 1/2"	2 1/2"	36	2 1/2"	2 1/2"	2 1/2"
8	75	3"	3"	42	3"	3"	3"
9	90	3 1/2"	3 1/2"	48	3 1/2"	3 1/2"	3 1/2"
10	100	4"	4"	-	4"	4"	4"

Other thread sizes available upon request

Table E

Code	Material
-	Brass
1	Aluminium
2	Nylon
3	Mild Steel
4	Stainless Steel 316
5	Nickel Plated Brass



ADAPTOR

REDUCER

737



737 Adaptors & Reducers, Globally Approved, Explosive Atmosphere Cable / Conduit Accessory

- Used for thread conversion
- Wide range of thread types & sizes
- General purpose / industrial version available
- Equipment interface 'O' ring seal available
- -60°C to +200°C (metallic versions)
- Globally marked, IECEx, ATEX, UL & cCSAus

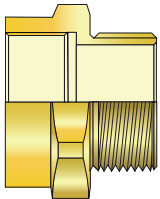

CMP 737 Adaptor

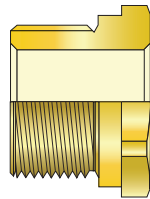

CMP 737 Reducer

HOW TO ORDER

e.g. 737-D-M-2M-3-4 = Dual Certified Ex d & Ex e – M20 (M) x M25 (F) - Stainless Steel

Please refer to Ordering Guide Tables for reference definitions, denoting material variants. When ordering please notify CMP Products in your order if alternative approval markings are required.

When ordering Adaptors & Reducers always state the Male Thread size first.

Other Thread Variations are available on request. For further information on ordering please refer to page 150.

It should be noted that when using CMP Type 737 Thread Conversion Adaptors and Reducers in association with Explosion Protected electrical equipment the following basic rules must be observed in line with good engineering practice:

1. For direct entry Ex d applications, only adaptor or reducer should be used per cable entry.
2. The female connection thread of a Thread Conversion Adaptor shall "step" not more than two "size" up in the case of a thread gender change. Example; M20 (M) to M32 (F) or M20 (M) to 1" NPT (F) is permitted. Whereas M20 (M) to M40 (F) or M20 (M) to 1½" NPT (F) is not permitted.

TECHNICAL DATA

Design Specification	BS 6121:Part 1:1989, IEC 62444, EN 62444
Enclosure Protection	IK10 to IEC 62262 (20 joules) Brass & Stainless Steel Only
ATEX Certificate	SIRA13ATEX1265X
Code of Protection	⊕ II 2G Ex d IIC Gb, Ex e IIC Gb, II 1D Ex ta IIIC Da ⊕ IM2 Ex d I Mb, Ex e I Mb (II 2G Ex e IIC Gb, II 1D Ex ta IIIC Da only on Nylon version)
Compliance Standards	EN 60079-0,1,7,31
IECEX Certificate	IECEX SIR13.0094X
Code of Protection	Ex d I Mb, Ex e I Mb, Ex d IIC Gb, Ex e IIC Gb, Ex ta IIIC Da (Ex e IIC Gb, Ex ta IIIC Da only on nylon version)
Compliance Standards	IEC 60079-0,1,7,31
cCSAus Certificate	1055233
Code of Protection	Class I, Groups A, B, C and D; IP66, 67, 68; Enclosure Type 4X; Class II groups E, F and G; Class III, Ex de II, Class I, Zone 1, AEx de II; (Not available in Nylon)
Compliance Standards	C22.2 No.0, 0.5, 30, 94, CAN/CSA E60079-0,1, 7, CAN-CSA E612411, UL50 Edition 11, UL1203 Edition 4, UL 60079-0,1,7
UL Certificate	E214221 (Reducers with NPT or Metric Threads only)
Code of Protection	Class I Groups A,B,C,D; Class II Groups E,F,G; Class III
Compliance Standards	UL 1203
EAC Certificate	TC RU C-GB.ГБ05.В00138
UkrSEPRO	UA.TR.047.C.0644-15
KCS Certificate	14-GA4B0-0249X
CCOE / PESO (India) Certificate	P333688
NEPSI Certificate	GYJ13.1142X
Compliance Standards	GB3836.1, 2, 3
INMETRO Approval	TÜV 12.1332X
RETIE Approval	03866
Marine Approvals	LRS: 01/00173 (E1), ABS: 01LD234401C/2PDA, BV: 43180/A1 BV
Continuous Operating Temperature	-60°C to +200°C (Metallic), -20°C to +60°C (Nylon)
Ingress Protection Rating**	IP66, IP67 & IP68***
Available Materials	Electroless Nickel Plated Brass, Brass, Nylon, Stainless Steel, Aluminium

** When CMP installation accessories are used. Refer to page 7 or www.cmp-products.com for further information.
*** IP68 tested to a minimum depth of 30 metres for 12 hours, alternate depths / durations can be provided upon request

CMP PRODUCTS THREAD CONVERSIONS & ACCESSORIES



737

Dimension Data Tables

- 1 Select male thread from the left hand column of Table 'A'
- 2 Select the female thread size from the top of Table 'A', referenced 'A**' for Adaptor and 'R**' for Reducer
- 3 Using this code reference, please refer to the corresponding dimensions in Table 'B'

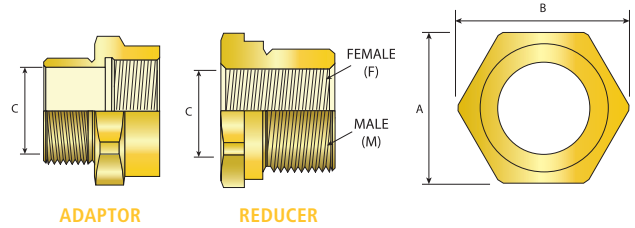

	METRIC										NPT									
	M16	M20	M25	M32	M40	M50	M63	M75	M90	M100	1/2"	3/4"	1"	1 1/4"	1 1/2"	2"	2 1/2"	3"	3 1/2"	4"
M16	A01	A04	A08								A03	A08								
M20	R01	A05	A07	A12							A05	A11	A15							
M25	R05	R03	A09	A14	A18						R03	A09	A16	A18						
M32	R06	R06	R06	A17	A19	A24					R06	R06	A17	A19	A24					
M40	R08	R08	R08	R08	A20	A29	A33				R08	R08	R08	A21	A25	A33				
M50	R10	R10	R10	R10	R10	A28	A35	A49			R11	R11	R10	R10	A27	A32	A42	A52		
M63		R12	R12	R12	R12	R12	A37	A48	A53		R12	R12	R12	R12	R12	A37	A44	A53		
M75		R14	R14	R14	R14	R16	R15	A47	A55	A57		R14	R14	R14	R14	R14	A46	A55	A61	
M90					R19	R19	R17	R19		A60							R18			
M100							R20	R20	R20										A58	
1/2"	R02	A06	A07	A12							A02	A10	A15							
3/4"	R04	R04	A09	A16	A22						R04	A09	A16	A18						
1"	R07	R07	R07	A13	A19						R07	R07	A17	A19	A24					
1 1/4"	R09	R09	R09	R09	A20	A23					R09	R09	R09	A20	A25	A30				
1 1/2"		R10	R10	R10	R11	A26	A43				R10	R10	R10	R10	A26	A31	A41			
2"		R12	R12	R12	R12	R12	A36	A43			R12	R12	R12	R12	R12		A39	A50		
2 1/2"		R14	R14	R14	R14	R13	R13	A40			R14	R14	R14	R14	R14	R14	A45	A54		
3"		R17	R19	R19		R18	R19	R19	A56		R17		R18	R18	R18	R18	R19	A51	A59	A62
3 1/2"				R17		R20	R20	R20	R20				R20	R20	R20	R20	R20	R20		
4"						R21	R21	R21					R21	R21	R21	R21	R21	R21	R21	

Table A Ref.	Across Flats 'A'	Across Corners 'B'
R01	24.0	26.4
R02	27.0	29.7
R03	30.0	33.0
R04	31.5	34.7
R05	31.5	34.7
R06	37.6	41.4
R07	41.0	45.1
R08	46.0	50.6
R09	50.0	55.0
R10	55.0	60.5
R11	60.0	66.0
R12	70.0	77.0
R13	79.0	86.9
R14	80.0	88.0
R15	84.0	92.4
R16	90.2	99.2
R17	95.0	104.5
R18	98.8	108.7
R19	100.0	110.0
R20	110.0	121.0
R21	123.0	135.3
R22	127.0	139.7

Table A Ref.	Across Flats 'A'	Across Corners 'B'	Minimum Bore 'C'	Table A Ref.	Across Flats 'A'	Across Corners 'B'	Minimum Bore 'C'
A01	22.0	24.2	9.7	A23	55.0	60.5	32.1
A02	24.0	26.4	14.0	A24	55.0	60.5	26.0
A03	24.0	26.4	9.7	A25	55.0	60.5	32.0
A04	24.0	26.4	10.0	A26	55.0	60.5	38.0
A05	24.0	26.4	14.0	A27	55.0	60.5	43.6
A06	27.0	29.7	14.0	A28	59.8	65.8	44.2
A07	30.0	33.0	14.0	A29	60.0	66.0	32.1
A08	30.0	33.0	9.7	A30	65.0	71.5	32.0
A09	30.0	33.0	20.0	A31	65.0	71.5	38.0
A10	30.5	33.6	14.0	A32	65.0	71.5	44.2
A11	31.5	34.7	14.0	A33	70.0	77.0	32.0
A12	36.0	39.6	14.0	A34	70.0	77.0	38.0
A13	36.0	39.6	26.0	A35	70.0	77.0	44.2
A14	37.6	41.4	20.0	A36	70.0	77.0	49.0
A15	41.0	45.1	14.0	A37	70.0	77.0	53.0
A16	41.0	45.1	20.0	A38	70.0	77.0	32.1
A17	41.0	45.1	26.0	A39	79.0	86.9	49.0
A18	46.0	50.6	20.0	A40	79.0	86.9	60.0
A19	46.0	50.6	26.0	A41	80.0	88.0	38.0
A20	46.0	50.6	32.1	A42	80.0	88.0	44.2
A21	50.0	55.0	32.0	A43	80.0	88.0	49.0
A22	50.0	55.0	20.0	A44	80.0	88.0	55.0
A23	55.0	60.5	32.1	A45	80.0	88.0	60.5
A24	55.0	60.5	26.0	A46	80.0	88.0	65.0
A25	55.0	60.5	32.0	A47	84.0	92.4	68.0
A26	55.0	60.5	38.0	A48	90.2	99.2	53.0
A27	55.0	60.5	43.6	A49	90.2	99.2	42.0
A28	59.8	65.8	44.2	A50	95.0	104.5	49.0
A29	60.0	66.0	32.1	A51	95.0	104.5	75.0
A30	65.0	71.5	32.0	A52	100.0	110.0	44.2
A31	65.0	71.5	38.0	A53	100.0	110.0	55.0
A32	65.0	71.5	44.2	A54	100.0	110.0	60.5
A33	70.0	77.0	32.0	A55	100.0	110.0	64.8
A34	70.0	77.0	38.0	A56	100.0	110.0	75.0
A35	70.0	77.0	44.2	A57	110.0	121.0	61.0
A36	70.0	77.0	49.0	A58	110.0	121.0	75.0
A37	70.0	77.0	53.0	A59	110.0	121.0	75.0
A38	70.0	77.0	32.1	A60	110.0	121.0	79.3
A39	79.0	86.9	49.0	A61	110.0	121.0	68.3
A40	79.0	86.9	60.0	A62	117.5	129.3	75.0

Additional sizes available upon request
Minimum reducer bore determined by female thread
Dimensions displayed in millimetres



SIZE 63 / 2" AND ABOVE

787



787 90° Adaptor, Globally Approved, Explosive Atmosphere Cable / Conduit Accessory

- Protects cables from excessive bending stress
- General purpose / industrial version available
- Supplied with male or female threads
- Can be supplied with thread conversion
- Equipment interface 'O' ring seal available
- -60°C to +200°C
- Globally marked, IECEx, ATEX & cCSAus
- Can be used with 737 (not Ex d direct entry applications)

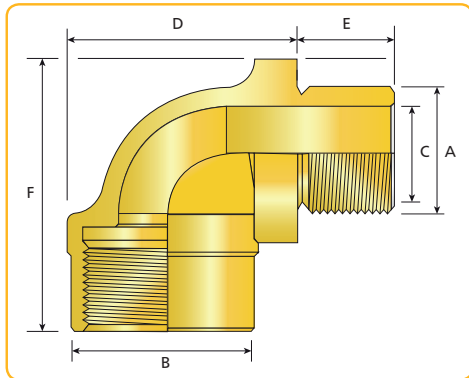

TECHNICAL DATA	
Design Specification	BS 6121:Part 1:1989, IEC 62444, EN 62444
Enclosure Protection	IK10 to IEC 62262 (20 joules) Brass & Stainless Steel Only
ATEX Certificate	SIRA14ATEX1033U
Code of Protection	⊕ II 2 G Ex d IIC Gb, Ex e IIC Gb, II 1 D Ex ta IIIC Da ⊕ IM2 Ex d I Mb, Ex e I Mb
Compliance Standards	EN 60079-0,1,7,31
IECEX Certificate	IECEX SIR14.0014U
Code of Protection	Ex d I Mb/ Ex e I Mb/ Ex d IIC Gb / Ex e IIC Gb / Ex ta IIIC Da
Compliance Standards	IEC 60079-0,1,7,31
cCSAus Certificate	1055233
Code of Protection	Class I, Groups A, B, C and D; IP66, 67, 68; Enclosure Type 4X; Ex de II, Class I, Zone 1, AEx de II;
Compliance Standards	C22.2 No. 0, 0.5-M1982, 30, 94, CAN/CSA E60079-0,1,7, UL 50, Edition 11, UL 1203, Edition 4, UL 60079-0,1,7
EAC Certificate	TC RU C-GB. ГБ05.B.00138
UkrSEPRO	UA.TR.047.C.0644-15
NEPSI Certificate	GYJ13.1142X
INMETRO Approval	TÜV 12.1335X
RETIE Approval	03866
Marine Approvals	LRS: 01/00173 (E1), ABS: 01LD234401C/2PDA, BV: 43180/A1
Ingress Protection Rating**	IP66, IP67 & IP68***
Available Materials	Brass, Electroless Nickel Plated Brass, Aluminium, Stainless Steel

** When CMP installation accessories are used. Refer to page 7 or www.cmp-products.com for further information.
*** IP68 tested to a minimum depth of 30 metres for 12 hours, alternate depths / durations can be provided upon request

HOW TO ORDER

e.g. 787 - D - M - 3 - M - 3 - 5
= Dual Certified Ex d & Ex e - M25 (M) x M25 (F) - Nickel Plated Brass

Other Thread Variations are available on request. For further information on ordering please refer to page 150.

Product Selection Table

Ordering Reference	Male Thread Size "A"	Minimum Thread Length "E"	Bore Diameter "C"	Female Thread Size	Protrusion Length "D"	Protrusion Length "F"	Width "B"	Installation Torque (Nm)
787DM2M2	M20 X 1.5	15.3	14.0	M20 X 1.5	29.6	41.0	24.0	7
787DM3M3	M25 X 1.5	15.3	18.6	M25 X 1.5	36.3	49.3	29.0	10
787DM4M4	M32 X 1.5	15.3	25.6	M32 X 1.5	45.2	56.3	36.0	15
787DM5N5	M40 X 1.5	15.3	33.6	M40 X 1.5	54.2	64.8	44.0	25
787DM6M6	M50 X 1.5	15.3	41.0	M50 X 1.5	68.3	74.0	54.0	30
787DM7M7	M63 X 1.5	15.3	50.0	M63 X 1.5	97.0	104.3	75.3	45
787DM8M8	M75 X 1.5	15.3	61.3	M75 X 1.5	97.0	111.3	79.5	45
787DM9M9	M90 X 2.0	15.3	80.0	M90 X 2.0	100.0	131.3	110.0	45
787DM10M10	M100 X 2.0	15.3	91.0	M100 X 2.0	110.0	141.3	115.0	45

All dimensions shown are in millimetres unless otherwise stated

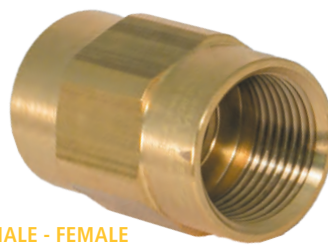

FEMALE - FEMALE

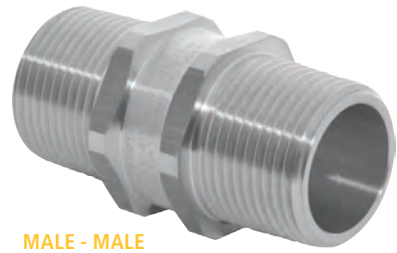

MALE - MALE

797



797 Male - Male or Female - Female Adaptor, Globally Approved, Explosive Atmosphere Cable / Conduit Accessory

- Designed to convert existing threads
- General purpose / industrial version available
- Supplied with male or female threads
- Can be supplied with thread conversion
- Equipment interface 'O' ring seal available on male-male
- -60°C to +200°C
- Globally marked, IECEx, ATEX & cCSAus
- Can be used with 737 (not Ex d direct entry applications)

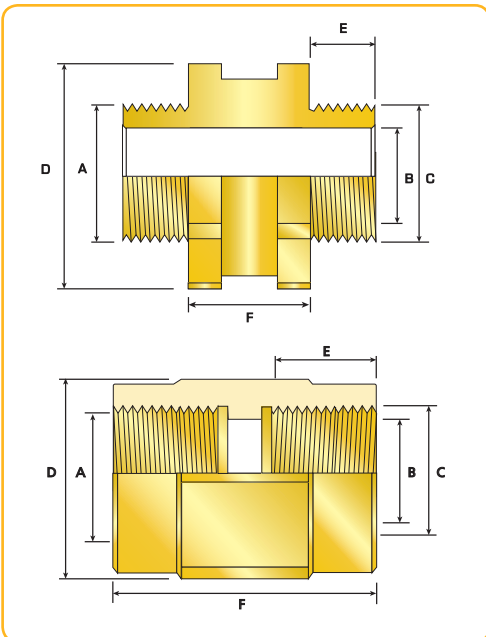

TECHNICAL DATA	
Design Specification	BS 6121:Part 1:1989, IEC 62444, EN 62444
Enclosure Protection	IK10 to IEC 62262 (20 joules) Brass & Stainless Steel Only
ATEX Certificate	SIRA13ATEX1265X
Code of Protection	Ⓜ II 2 G Ex d IIC Gb, Ex e IIC Gb, II 1 D Ex ta IIIC Da Ⓜ IM2 Ex d I Mb, Ex e I Mb
Compliance Standards	EN 60079-0,1,7,31
IECEx Certificate	IECEx SIR13.0094X
Code of Protection	Ex d I Mb/ Ex e I Mb/ Ex d IIC Gb / Ex e IIC Gb / Ex ta IIIC Da
Compliance Standards	IEC 60079-0,1,7,31
cCSAus Certificate	1055233
Code of Protection	Ex de II; Class I, Groups A, B, C and D; Class I, Zone 1, AEx de II; IP66, 67, and 68, Enclosure Type 4X.
Compliance Standards	C22.2 No. 0, 0.5-M1982, 30, 94, CAN/CSA E60079-0,1,7, UL 50, Edition 11, UL 1203, Edition 4, UL 60079-0,1,7
EAC Certificate	TC RU C-GB. ГБ05.B.00138
UkrSEPRO	UA.TR.047.C.0644-15
KCS Certificate	14-GA4BO-0250X
CCOE / PESO (India) Certificate	P333688
NEPSI Certificate	GYJ13.1142X
INMETRO Approval	TÜV 12.1332X
RETIE Approval	03866
Marine Approvals	LRS: 01/00173 (E1), ABS: 01LD234401C/2PDA,
Ingress Protection Rating**	IP66, IP67 & IP68***
Available Materials	Brass, Electroless Nickel Plated Brass, Aluminium, Stainless Steel

** When CMP installation accessories are used. Refer to page 7 or www.cmp-products.com for further information.
 *** IP68 tested to a minimum depth of 30 metres for 12 hours, alternate depths / durations can be provided upon request

HOW TO ORDER

e.g. 797 - D - M - 3 - F - M - 3 - F - 5
 = Dual Certified Ex d & Ex e - M25 (F) x M25 (F) - Nickel Plated Brass

Other Thread Variations are available on request. For further information on ordering please refer to page 150.

Product Selection Table

Ordering Reference	Male/Female Forward Thread Size "C"	Minimum Thread Length "E"	Male/Female Rear Thread "A"	Across Flats "D"	Across Corners "D"	Bore Diameter "B"	Protrusion "F" M/M	Protrusion "F" F/F	Installation Torque (Nm)
797DM1FM1F	M16 X 1.5	15.0	M16 X 1.5	24.0	26.4	14.0	18.0	48.0	7
797DM2FM2F	M20 X 1.5	15.0	M20 X 1.5	24.0	26.4	14.0	18.0	48.0	7
797DM3FM3F	M25 X 1.5	15.0	M25 X 1.5	30.5	33.5	20.0	18.0	48.0	10
797DM4FM4F	M32 X 1.5	15.0	M32 X 1.5	36.0	39.6	26.8	18.0	48.0	15
797DM5FM5F	M40 X 1.5	15.0	M40 X 1.5	46.0	50.6	32.7	20.0	50.0	25
797DM6FM6F	M50 X 1.5	15.0	M50 X 1.5	55.0	60.5	44.1	20.0	50.0	30
797DM7FM7F	M63 X 1.5	15.0	M63 X 1.5	70.1	77.1	55.6	20.0	50.0	45
797DM8FM8F	M75 X 1.5	15.0	M75 X 1.5	80.0	88.0	65.6	21.0	51.0	45
797DM9FM9F	M90 X 2.0	24.0	M90 X 2.0	100.0	110.0	82.0	23.0	53.0	45
797DM10FM10F	M100 X 2.0	24.0	M100 X 2.0	108.0	118.8	91.1	23.0	53.0	45

All dimensions shown are in millimetres unless otherwise stated



TYPE A

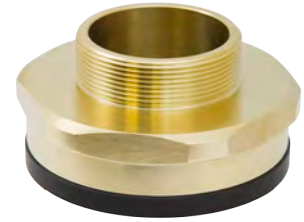

TYPE B

777



777 Insulated Adaptor, Globally Approved, Explosive Atmosphere Cable / Conduit Accessory

- Isolates metallic Cable Glands from equipment
- Essential in areas of high electromagnetic noise
- Particularly relevant in power plants
- General purpose / industrial version available
- Can be supplied with thread conversion
- -60°C to +130°C
- Globally marked, IECEx, ATEX & cCSAus

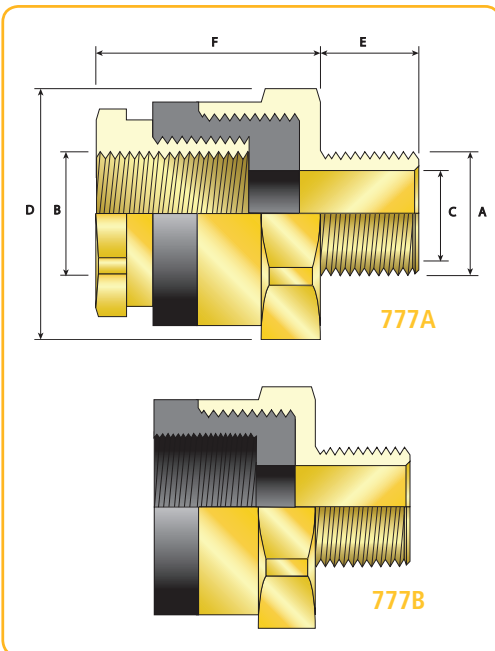

TECHNICAL DATA

Design Specification	BS 6121:Part 1:1989, IEC 62444, EN 62444
Enclosure Protection	IK10 to IEC 62262 (20 joules) Brass & Stainless Steel Only
ATEX Certificate	SIRA10ATEX1057U
Code of Protection	⊕ II 2 GD Ex d IIC Gb / Ex e IIC Gb / Ex ta IIIC Da
Compliance Standards	EN 60079-0,1,7,31
IECEx Certificate	IECEx SIR 10.0027U
Code of Protection	Ex d IIC Gb / Ex e IIC Gb / Ex ta IIIC Da
Compliance Standards	IEC 60079-0,1,7,31
cCSAus Certificate	1055233
Code of Protection	Class I, Groups A, B, C and D; IP66, 67, 68; Enclosure Type 4X; DIP A; Ex de II, Class I, Zone 1, AEx de II;
Compliance Standards	C22.2 No. 0, 0.5, 30, 94, CAN/CSA E60079-0,1,2, UL 50 Edition 11, UL 1203 Edition 4, UL 60079 parts 0,1,7
EAC Certificate	TC RU C-GB.ГБ05.В00138
UkrSEPRO	UA.TR.047.C.0644-15
CCOE / PESO (India) Certificate	P333688
INMETRO Approval	TÜV 12.1331U
RETIE Approval	03866
Marine Approvals	LRS: 01/00172 (E1), ABS: 01LD234401C/2PDA,
Ingress Protection Rating**	IP66, IP67 & IP68***
Available Materials	Brass, Electroless Nickel Plated Brass, Aluminium, Stainless Steel

** When CMP installation accessories are used. Refer to page 7 or www.cmp-products.com for further information.#

*** IP68 tested to a minimum depth of 30 metres for 12 hours, alternate depths / durations can be provided upon request

HOW TO ORDER

e.g. 777 - D - A - M - 3 - M - 3 - 5

= Dual Certified Ex d & Ex e - Type A - M25 (M) x M25 (F) - Nickel Plated Brass

Other Thread Variations are available on request. For further information on ordering please refer to page 150.

For Type B insulated adaptors, please substitute the Letter A with the Letter B in the table below. Please note that the Type B version of the 777 insulated adaptors are only certified Ex d when they are installed in conjunction with a corresponding CMP certified cable gland.

Product Selection Table

Ordering Reference	Male Thread Size "A"	Minimum Thread Length "E"	Female Thread Size "B"	Maximum Bore Diameter "C"	Normal Protrusion Length "F" (Type A)	Across Flats "D"	Across Corners "D"
777DAM2M2	M20 X 1.5	15.0	M20 X 1.5	14.0	37.8	36.0	39.6
777DAM3M3	M25 X 1.5	15.0	M25 X 1.5	20.0	36.2	46.0	50.6
777DAM4M4	M32 X 1.5	15.0	M32 X 1.5	26.3	35.7	55.0	60.5
777DAM5M5	M40 X 1.5	15.0	M40 X 1.5	32.1	35.7	70.1	77.1
777DAM6M6	M50 X 1.5	15.0	M50 X 1.5	44.2	36.7	80.0	88.0
777DAM7M7	M63 X 1.5	15.0	M63 X 1.5	53.0	38.2	100.0	110.0
777DAM8M8	M75 X 1.5	15.0	M75 X 1.5	64.8	41.2	110.0	123.0
777DAM9M9	M90 X 2.0	24.0	M90 X 2.0	79.3	52.7	132.2	135.5

All dimensions shown are in millimetres unless otherwise stated



783



783 Dual Entry Y Adaptor, Internationally Approved, Explosive Atmosphere Cable / Conduit Accessory

- Provides an opportunity for two entries
- As standard one male & two female entries
- Supplied with male or female threads upon request
- All angles 120°
- Protects cables from excessive bending stress
- General purpose / industrial version available
- Can be supplied with thread conversion upon request
- -60°C to +200°C
- Globally marked, IECEx, ATEX & EAC (TC RU)
- Can be used with 737 (not Ex d direct entry applications)

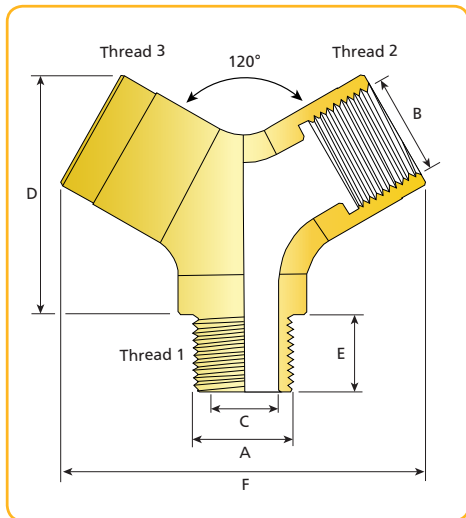

TECHNICAL DATA

Design Specification	BS 6121:Part 1:1989, IEC 62444, EN 62444
Enclosure Protection	IK10 to IEC 62262 (20 joules) Brass & Stainless Steel Only
ATEX Certificate	SIRA16ATEX1234U
Code of Protection	⊕ II 2G Ex db IIC Gb, Ex eb IIC Gb, II 1D Ex ta IIIC Da ⊕ IM2 Ex db I Mb, Ex eb I Mb
Compliance Standards	EN 60079-0,1,7,31
IECEX Certificate	IECEX SIR16.0081U
Code of Protection	Ex db IIC Gb, Ex eb IIC Gb, Ex ta IIIC Da Ex db I Mb, Ex eb I Mb,
Compliance Standards	IEC 60079-0,1,7,31
EAC Certificate	TCRU C-GB.M062.B.04359
Ingress Protection Rating**	IP66, IP67 & IP68***
Available Materials	Brass, Electroless Nickel Plated Brass, Stainless Steel

** When CMP installation accessories are used. Refer to page 7 or www.cmp-products.com for further information.
*** IP68 tested to a minimum depth of 30 metres for 12 hours, alternate depths / durations can be provided upon request

HOW TO ORDER

e.g. 783 - D - M - 2 - M - M - 2 - F - M - 2 - F - 5
= Dual Certified Ex d & Ex e - M20 (M) x M20 (F) x M20 (F) - Nickel Plated Brass

* Any combination of Male (M) / Female (F) threads is available e.g. (M) X (M) X (M), (F) X (F) X (F), (M) X (F) X (M)

Other Thread Variations are available on request. For further information on ordering please refer to page 150.

Product Selection Table

Ordering Reference	Bore Diameter 'C'	Thread 1 'A' (Entry Thread)	Thread 2 'B'	Thread 3 'B'	Thread Length 'E'	Protrusion Length 'D'	Protrusion Length 'F'	Width
783DM2MM2FM2F	14.7	M20	M20	M20	15.0	48.0	73.0	25 - 27
783DT1MT1FT1F	14.7	½" NPT	½" NPT	½" NPT	19.9	43.0	73.0	25 - 27
783DM3MM3FM3F	18.9	M25	M25	M25	15.0	48.0	76.9	30 - 32
783DT2MT2FT2F	18.9	¾" NPT	¾" NPT	¾" NPT	20.2	48.0	76.9	30 - 32
783DM4MM4FM4F	25.9	M32	M32	M32	15.0	56.5	92.5	37 - 39
783DT3MT3FT3F	25.9	1" NPT	1" NPT	1" NPT	25.0	56.5	92.5	37 - 39

All dimensions shown are in millimetres unless otherwise stated



TYPE B



TYPE A

747



747 Recessed Stopper Plug, Globally Approved, Explosive Atmosphere Cable / Conduit Accessory

- Provides means of blanking unused cable entries
- Temporary or permanent
- Tamper-proof (Type B) version available
- General purpose / industrial version available
- Nylon Ex e only version available (-20°C to +60°C)
- -60°C to 200°C (metallic versions)
- Globally marked, IECEx, ATEX, cCSAus & UL

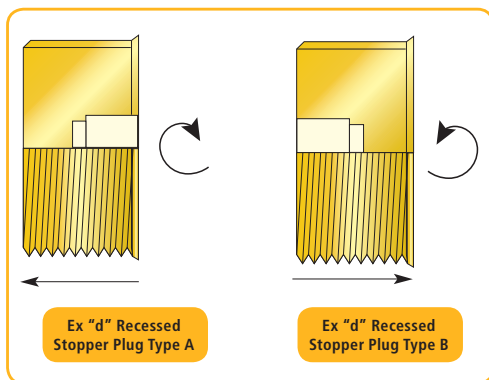

HOW TO ORDER

e.g. 747 - D - A - M - 3 - 1

= Dual Certified Ex d & Ex e - Type A - M25 - Aluminium

For Tamper Proof Type B Stopper Plugs please substitute the letter A with the letter B in the Ordering Reference list opposite.

Other Thread Variations are available on request. For further information on ordering please refer to page 150.

Description	Allen key recess	Metallic			Non-Metallic	
		Ex "d"	Ex "e"	Industrial	Ex "e"	Industrial
747 Recessed Non-Tamper Proof Type A	✓	✓	✓	✓	✓	✓
747 Recessed Tamper Proof Type B	✓	✓	✓	✓	✓	✓
757 Hexagon Head	x	✓	✓	✓	✓	✓
757 Hexagon Head c/w 'O' ring seal	x	✓	✓	✓	✓	✓
767 Dome Head	✓	✓	✓	✓	✓	✓
767 Dome Head c/w 'O' ring seal	✓	✓	✓	✓	✓	✓

TECHNICAL DATA

Design Specification	BS 6121:Part 1:1989, IEC 62444, EN 62444
Enclosure Protection	IK10 to IEC 62262 (20 joules) Brass & Stainless Steel Only
ATEX Certificate	SIRA13ATEX1265X
Code of Protection	Ⓜ II 2G Ex d IIC Gb, Ex e IIC Gb, II 1D Ex ta IIIC Da Ⓜ IM2 Ex d I Mb, Ex e I Mb (II 2G Ex e IIC Gb, II 1D Ex ta IIIC Da only on Nylon version)
Compliance Standards	EN 60079-0,1,7, 31
IECEx Certificate	IECEx SIR 13.0094X
Code of Protection	Ex d I Mb, Ex e I Mb; Ex d IIC Gb, Ex e IIC Gb, Ex ta IIIC Da
Compliance Standards	IEC 60079-0,1, 7, 31
cCSAus Certificate	1055233
Code of Protection	Class I, Groups A, B, C and D; IP66, 67, 68, Enclosure Type 4X; Class II Groups E, F and G; Class III Ex de II, Class I, Zone 1, AEx de II;
Compliance Standards	C22.2 No. 0, 0.5, 30,94,CAN/CSA E60079-0, 1, 7, UL50 Edition 11, UL1203 Edition 4, UL 60079-0, 1, 7
UL Certificate	E214221
Code of Protection	Class I, Groups A,B,C,D; Class II Groups E,F,G; Class III
Compliance Standards	UL 1203
EAC Certificate	TC RU C-GB.F505.B00138
UkrSEPRO	UA.TR.047.C.0644-15
KCS Certificate	14-GA4BO-0247X
CCOE / PESO (India) Certificate	P333688
NEPSI Certificate	GJ13.1143X
RETIE Approval	03866
INMETRO Approval	TÜV 12.1333X
RETIE Approval	03866
Marine Approvals	LRS: 01/00173 (E1) DNV: E-13848 ABS: 01LD234401C/2PDA, BV: 43180/A1
Continuous Operating Temperature	-60°C to +200°C (Metallic), -20°C to +60°C (Nylon)
Ingress Protection Rating**	IP66
Available Materials	Brass, Electroless Nickel Plated Brass, Aluminium, Stainless Steel, Nylon

** When CMP installation accessories are used. Refer to page 7 or www.cmp-products.com for further information.

Product Selection Table

Ordering Reference	Thread Size	Minimum Thread Length	Allen Key Size A/F
747DAM1	M16 X 1.5	15.0	M8
747DAM2	M20 X 1.5	15.0	M10
747DAM3	M25 X 1.5	15.0	M10
747DAM4	M32 X 1.5	15.0	M10
747DAM5	M40 X 1.5	15.0	M10
747DAM6	M50 X 1.5	15.0	M10
747DAM7	M63 X 1.5	15.0	M14
747DAM8	M75 X 1.5	15.0	M14
747DAM9	M90 X 2.0	24.0	M14
747DAM10	M100 X 2.0	24.0	M14

All dimensions shown are in millimetres unless otherwise stated



757



757 Hexagon Head Stopper Plug, Globally Approved, Explosive Atmosphere Cable / Conduit Accessory

- Provides means of blanking unused cable entries
- Temporary or permanent
- General purpose / industrial version available
- Equipment interface 'O' ring seal available
- Nylon Ex e only version available (-20°C to +60°C)
- -60°C to 200°C (metallic versions)
- Globally marked, IECEx, ATEX, cCSAus & UL

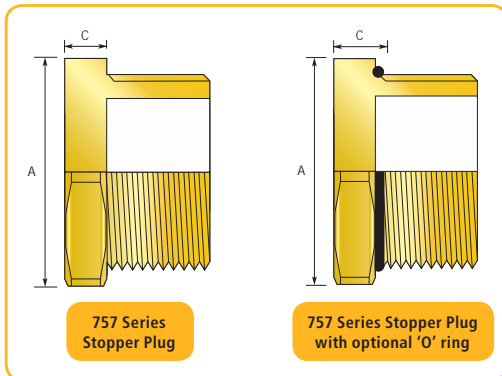

HOW TO ORDER

e.g. 757 - D - M - 3 - 1
= Dual Certified Ex d & Ex e - M25 - Aluminium

Other Thread Variations are available on request. For further information on ordering please refer to page 150.

When ordered with the integral 'O' ring seal the across flats dimension shown may increase to accommodate the 'O' ring.

Description	Allen key recess	Metallic			Non-Metallic	
		Ex "d"	Ex "e"	Industrial	Ex "e"	Industrial
747 Recessed Non-Tamper Proof Type 'A'	✓	✓	✓	✓	✓	✓
747 Recessed Tamper Proof Type 'B'	✓	✓	✓	✓	✓	✓
757 Hexagon Head	x	✓	✓	✓	✓	✓
757 Hexagon Head c/w 'O' ring seal	x	✓	✓	✓	✓	✓
767 Dome Head	✓	✓	✓	✓	✓	✓
767 Dome Head c/w 'O' ring seal	✓	✓	✓	✓	✓	✓

TECHNICAL DATA	
Design Specification	BS 6121:Part 1:1989, IEC 62444, EN 62444
Enclosure Protection	IK10 to IEC 62262 (20 joules) Brass & Stainless Steel Only
ATEX Certificate	SIRA13ATEX1265X
Code of Protection	⊕ II 2G Ex d IIC Gb, Ex e IIC Gb, II 1D Ex ta IIIC Da ⊕ IM2 Ex d I Mb, Ex e I Mb (II 2G Ex e IIC Gb, II 1D Ex ta IIIC Da only on Nylon version)
Compliance Standards	EN 60079-0,1,7, 31
IECEx Certificate	IECEx SIR 13.0094X
Code of Protection	Ex d I Mb, Ex e I Mb; Ex d IIC Gb, Ex e IIC Gb, Ex ta IIIC Da
Compliance Standards	IEC 60079-0,1, 7, 31
cCSAus Certificate	1055233
Code of Protection	Ex e II, Class I, Zone 1, AEx e II; IP66, 67, 68; Enclosure Type 4X; Class II Groups E, F and G; Class III
Compliance Standards	C22.2 No. 0, 0.5, 30,94,CAN/CSA E60079-0, 1, 7, UL50 Edition 11, UL1203 Edition 4, UL 60079-0, 1, 7
UL Certificate	E214221
Code of Protection	Class I Div 1 & 2, Groups A,B,C,D; Class II Groups E,F,G; Class III
Compliance Standards	UL 1203
EAC Certificate	TC RU C-GB.F605.B00138
UkrSEPRO	UA.TR.047.C.0644-15
KCS Certificate	14-GA4B0-0255X
CCOE / PESO (India) Certificate	P333688
NEPSI Certificate	GY13.1143X
INMETRO Approval	TÜV 12.1333X
RETIE Approval	03866
Marine Approvals	LRS: 01/00173 (E1) DNV: E-13848 ABS: 01LD234401C/2PDA, BV: 43180/A1
Continuous Operating Temperature	-60°C to +200°C (Metallic), -20°C to +60°C (Nylon)
Ingress Protection Rating**	IP66, IP67 & IP68***
Available Materials	Brass, Electroless Nickel Plated Brass, Aluminium, Stainless Steel, Nylon

* Dimensions shown for metric threads alternative thread dimensions may vary
 ** When CMP installation accessories are used. Refer to page 7 or www.cmp-products.com for further information.
 *** IP68 tested to a minimum depth of 30 metres for 12 hours, alternate depths / durations can be provided upon request

Product Selection Table*					
Ordering Reference	Thread Size	Minimum Thread Length	Across Flats "A"	Across Corners Diameter	Protrusion Length "C"
757DM1	M16 X 1.5	15.0	22.0	24.2	5.0
757DM2	M20 X 1.5	15.0	24.0	26.4	5.0
757DM3	M25 X 1.5	15.0	30.0	33.0	5.0
757DM4	M32 X 1.5	15.0	36.0	39.6	5.0
757DM5	M40 X 1.5	15.0	46.0	50.6	5.0
757DM6	M50 X 1.5	15.0	55.0	60.5	5.0
757DM7	M63 X 1.5	15.0	70.0	77.0	5.0
757DM8	M75 X 1.5	15.0	80.0	88.0	5.0
757DM9	M90 X 2.0	24.0	99.0	108.9	5.0
757DM10	M100 X 2.0	24.0	108.0	118.8	5.0

All dimensions shown are in millimetres unless otherwise stated



767



767 Dome Head Stopper Plug, Globally Approved, Explosive Atmosphere Cable / Conduit Accessory

- Provides means of blanking unused cable entries
- Temporary or permanent
- General purpose / industrial version available
- Equipment interface 'O' ring seal available
- Nylon Ex e only version available (-20°C to +60°C)
- -60°C to 200°C (metallic versions)
- Globally marked, IECEx, ATEX, cCSAus & UL

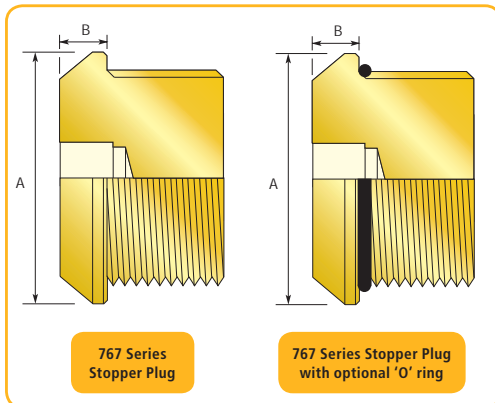

HOW TO ORDER

e.g. 767 - D - M - 3 - 1
= Dual Certified Ex d & Ex e - M25 - Aluminium

Other Thread Variations are available on request. For further information on ordering please refer to page 150.

When ordered with the integral 'O' ring seal the head diameter 'A' dimension shown may increase to accommodate the 'O' ring.

Description	Allen key recess	Metallic			Non-Metallic	
		Ex "d"	Ex "e"	Industrial	Ex "e"	Industrial
747 Recessed Non-Tamper Proof Type 'A'	✓	✓	✓	✓	✓	✓
747 Recessed Tamper Proof Type 'B'	✓	✓	✓	✓	✓	✓
757 Hexagon Head	x	✓	✓	✓	✓	✓
757 Hexagon Head c/w 'O' ring seal	x	✓	✓	✓	✓	✓
767 Dome Head	✓	✓	✓	✓	✓	✓
767 Dome Head c/w 'O' ring seal	✓	✓	✓	✓	✓	✓

TECHNICAL DATA

Design Specification	BS 6121:Part 1:1989, IEC 62444, EN 62444
Enclosure Protection	IK10 to IEC 62262 (20 joules) Brass & Stainless Steel Only
ATEX Certificate	SIRA13ATEX1265X
Code of Protection	⊕ II 2G Ex d IIC Gb, Ex e IIC Gb, II 1D Ex ta IIIC Da ⊕ IM2 Ex d I Mb, Ex e I Mb (II 2G Ex e IIC Gb, II 1D Ex ta IIIC Da only on Nylon version)
Compliance Standards	EN 60079-0,1,7, 31
IECEx Certificate	IECEx SIR 13.0094X
Code of Protection	Ex d I Mb, Ex e I Mb; Ex d IIC Gb, Ex e IIC Gb, Ex tb IIIA Db
Compliance Standards	IEC 60079-0,1, 7, 31
cCSAus Certificate	1055233
Code of Protection	Class I, Groups A, B, C and D; IP66, 67, 68; Enclosure Type 4X; Class II groups E, F and G; Class III Ex de II, Class I, Zone 1, AEx de II;
Compliance Standards	C22.2 No. 0, 0.5, 30,94,CAN/CSA E60079-0, 1, 7, UL50 Edition 11, UL1203 Edition 4, UL 60079-0, 1, 7
UL Certificate	E214221
Code of Protection	Class I, Groups A,B,C,D; Class II Groups E,F,G; Class III
Compliance Standards	UL 1203
EAC Certificate	TC RU C-GB.ГБ05.В00138
UkrSEPRO	UA.TR.047.C.0644-15
KCS Certificate	14-GA4B0-0248X
CCOE / PESO (India) Certificate	P333688
NEPSI Certificate	GY113.1143X
INMETRO Approval	TÜV 12.1333X
RETIE Approval	03866
Marine Approvals	LRS: 01/00173 (E1) DNV: E-13848 ABS: 01LD234401C/2PDA, BV: 43180/A1
Continuous Operating Temperature	-60°C to +200°C (Metallic), -20°C to +60°C (Nylon)
Ingress Protection Rating**	IP66, IP67 & IP68***
Available Materials	Brass, Electroless Nickel Plated Brass, Aluminium, Stainless Steel, Nylon

** When CMP installation accessories are used. Refer to page 7 or www.cmp-products.com for further information.

*** IP68 tested to a minimum depth of 30 metres for 12 hours, alternate depths / durations can be provided upon request

Product Selection Table

Ordering Reference	Thread Size	Minimum Thread Length	Head Diameter "A"	Protrusion Length "B"	Allen Key Size A/F
767DM1	M16 X 1.5	15.0	22.0	5.5	M8
767DM2	M20 X 1.5	15.0	27.0	5.5	M10
767DM3	M25 X 1.5	15.0	30.0	5.5	M10
767DM4	M32 X 1.5	15.0	36.0	5.5	M10
767DM5	M40 X 1.5	15.0	46.0	5.5	M10
767DM6	M50 X 1.5	15.0	55.0	5.5	M10
767DM7	M63 X 1.5	15.0	68.0	5.5	M10
767DM8	M75 X 1.5	15.0	80.0	5.5	M14
767DM9	M90 X 2.0	24.0	95.0	5.5	M14
767DM10	M100 x 2.0	24.0	108.0	5.5	M14

All dimensions shown are in millimetres unless otherwise stated



TYPE E

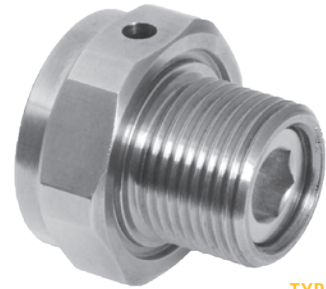

TYPE D

781



781 Breather / Drain Plug, Globally Approved, Explosive Atmosphere Cable / Conduit Accessory

- 781E for Ex e use
- 781D for Ex d use
- Drains equipment susceptible to moisture collection
- Enables equipment to breathe
- General purpose / industrial version available
- Nylon Ex e only version available (-20°C to +60°C)
- -60°C to 130°C (metallic versions)
- Globally marked, IECEx, ATEX & cCSAus

781D

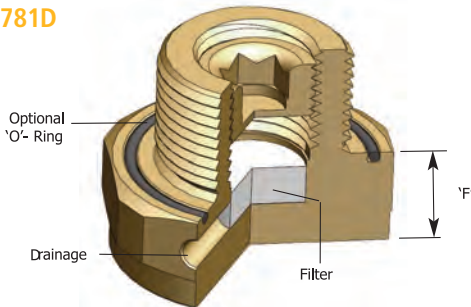

781E

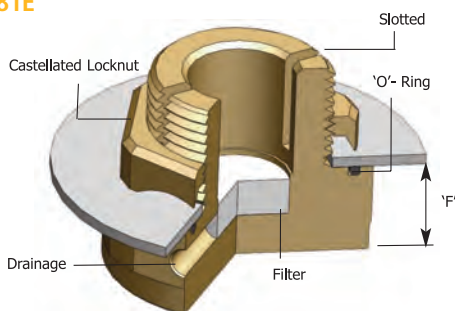

TECHNICAL DATA

Design Specification	BS 6121:Part 1:1989, IEC 62444, EN 62444
Enclosure Protection	IK10 to IEC 62262 (20 joules) Brass & Stainless Steel Only
ATEX Certificate	SIRA 10 ATEX 1307U
Code of Protection	781D: Ex d IIC Gb, II 2G Ex d IIC Gb, II 1D Ex ta IIIC Da 781E: Ex e IIC Gb, II 2G Ex e IIC Gb, II 1D Ex ta IIIC Da
Compliance Standards	EN 60079-0,1,7,31
IECEX Certificate	IECEX SIR 10.0149U
Code of Protection	781D: Ex d IIC Gb, Ex ta IIIC Da 781E: Ex e IIC Gb, Ex ta IIIC Da
Compliance Standards	IEC 60079-0,1,7,31
cCSAus Certificate	1055233
Code of Protection	781D: Ex d IIC, Class I, Zone 1 AEx d IIC; Class I Div 1, Groups A,B,C,D IP66, Enclosure Type 4X 781E: Ex e II, Class I, Zone 1, AEx e II IP66, Enclosure Type 4X
Compliance Standards	CSA C22.2 No 0-10, 0.5, 30, 94; e 90079-0,1,7, E6124111, UL50, 1203, UL60079-0,1,7
EAC Certificate	TC RU C-GB.Г505.В.00138
UkrSEPRO	UA.TR.047.C.0644-15
CCOE / PESO (India) Certificate	P333688
INMETRO Certificate	TÜV 12.1330U
RETIE Approval	03866
NEPSI Certificate	GY13.1139X (781D) GY13.1138X (781E)
RETIE Approval	03866
Continuous Operating Temperature	781D: -60°C to +130°C 781E: -60°C to +130°C (-20°C to +60°C Nylon)
Ingress Protection Rating**	781D: IP66 (when fitted with CMP sealing accessories) 781E: IP66 (with 'O' ring interface seal and lock nut as standard)
Available Materials	Brass, Nickel Plated Brass, Aluminium, Stainless Steel, Nylon (781E only)
Accessories Included (781E only)	Integral Entry Thread equipment interface 'O' ring seal, Castellated Locknut

The 781D can be used with enclosures up to 30 litres for group IIB gases and enclosures up to 2.5 litres for group IIC gases
** When CMP installation accessories are used (781E), Refer to page 7 or www.cmp-products.com for further information.

HOW TO ORDER

e.g. 781 - D - M - 3 = Ex d - M25
e.g. 781 - E - M - 3 = Ex e - M25

Other Thread Variations are available on request. For further information on ordering please refer to page 150.

The CMP 781E range of Increased Safety type 'e' breather / drain plugs have been tested together with CMP serrated washers to ensure that in areas that are subject to vibration the plug does not suffer from self-loosening and inadvertently fall out of the enclosure. Serrated washers are not included as standard but can be ordered separately.

Product Selection Table

Ordering Reference (781D)	Ordering Reference (781E)	Thread Size	Minimum Thread Length	Protrusion Length "F"	Across Flats Dimension	Across Corners Dimensions	Max Installation Torque (Nm)
781DM2	781EM2	M20 x 1.5	15.0	12.7	30.0	33.0	7
781DM3	781EM3	M25 x 1.5	15.0	12.7	36.0	39.6	10
781DT1	781ET1	½" NPT	19.9	12.7	30.0	33.0	7
781DT2	781ET2	¾" NPT	20.2	12.7	36.0	39.6	10

All dimensions shown are in millimetres unless otherwise stated

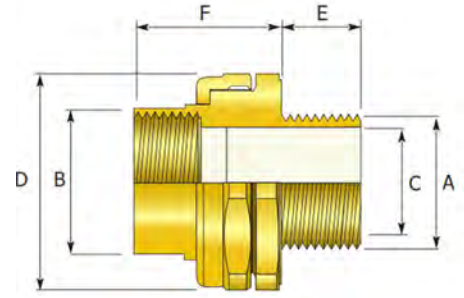

780



780 In-Line Union, Globally Approved, Explosive Atmosphere Cable / Conduit Accessory

- Allows the connection of conduit or glands to equipment
- Suitable for rigid or flexible conduit
- Integral coupling eliminates the need to rotate the conduit
- General Purpose / industrial version available
- Equipment interface 'O' ring seal available
- -60°C to 200°C
- Globally marked, IECEx, ATEX & cCSAus

Male-to-Male thread option available.

Available with an equipment interface 'O' ring seal. For such options please add the suffix letter "R" after the type number in the ordering reference above, e.g. 780RDM2M2.

If 2 separate enclosures are required to be connected together please contact CMP Products.

Technical Data

Design Specification	BS 6121:Part 1:1989, IEC 62444, EN 62444
Enclosure Protection	IK10 to IEC 62262 (20 joules) Brass & Stainless Steel only
ATEX Certification	SIRA10ATEX1306U
Code of Protection	⊕ II 2 GD Ex d IIC Gb, Ex e IIC Gb, Ex ta IIIC Da IP6X ⊕ IM2 Ex d I Mb / Ex e I Mb
Compliance Standards	EN 60079-0,1,7,31
IECEx Certificate	IECEx SIR 10.0148U
Code of Protection	Ex d IIC Gb, Ex e IIC Gb, Ex ta IIIC Da IP6X, Ex d I Mb, Ex e I Mb
Compliance Standards	IEC 60079-0,1,7,31
cCSAus Certificate	1055233
Code of Protection	Class I, Div 1 & 2, Groups A,B,C,D ; Enclosure type 4X : Class I, Zone 1, AEx de II ; Ex de II
Compliance Standards	C22.2 No.0,0.5,30,94, CAN/CSA E60079-0,1,7, CAN/CSA E612411, UL Std 50, 1203, UL 60079-0,1,7
EAC Certificate	TC RU C-GB.ГБ05.В00138
UkrSEPRO	UA.TR.047.C.0644-15
INMETRO Approval	TÜV 12.1334U
NEPSI Certificate	GYJ13.1142X
Ingress Protection Rating**	IP66
Available Materials	Brass (standard), Electroless Nickel Plated Brass, Aluminium, Stainless Steel

** When CMP installation accessories are used. Refer to page 7 or www.cmp-products.com for further information.

Product Selection Table

METRIC					NPT					Max Protrusion Length "F"	Across Flats Hex "D"	Across Corners Ø "D"	Installation Torque (Nm)
Ordering Reference (Brass, Metric)	Male Forward Thread Size "A"	Minimum Thread Length "E"	Female Rear Thread Size "B"	Bore Diameter "C"	Ordering Reference (Brass, NPT)	Male Forward NPT Thread Size "A"	Minimum NPT Thread Length "E" (in)	Female Rear Thread Size "B"	Bore Diameter "C"				
780DM2M2	M20 X 1.5	15.0	M20 X 1.5	14.3	780DT1T1	½"	0.79	½"	14.3	36.0	41.0	45.1	7
780DM3M3	M25 X 1.5	15.0	M25 X 1.5	20.1	780DT2T2	¾"	0.80	¾"	20.1	36.0	46.0	50.6	10
780DM4M4	M32 X 1.5	15.0	M32 X 1.5	26.4	780DT3T3	1"	0.98	1"	26.4	36.0	52.0	57.2	15
780DM5M5	M40 X 1.5	15.0	M40 X 1.5	32.6	780DT4T4	1¼"	1.01	1¼"	32.6	36.0	60.0	66.0	25
780DM6M6	M50 X 1.5	15.0	M50 X 1.5	44.2	780DT5T5	1½"	1.03	1½"	40.3	36.0	70.1	77.1	30
780DM7M7	M63 X 1.5	15.0	M63 X 1.5	56.1	780DT6T6	2"	1.06	2"	50.4	36.0	79.0	86.9	45
780DM8M8	M75 X 1.5	15.0	M75 X 1.5	68.1	780DT7T7	2½"	1.57	2½"	60.0	41.0	89.9	98.9	45
780DM9M9	M90 X 2.0	24.0	M90 X 2.0	80.1	780DT8T8	3"	1.63	3"	75.0	41.0	110.0	121.0	45

All dimensions shown are in millimetres unless otherwise stated

For material options please add the following suffix to the Ordering Reference; Brass (no suffix required), Nickel Plated Brass "5", 316 Grade Stainless Steel "4", Copper Free Aluminium "1"

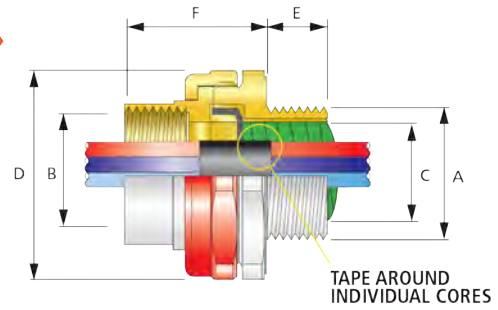
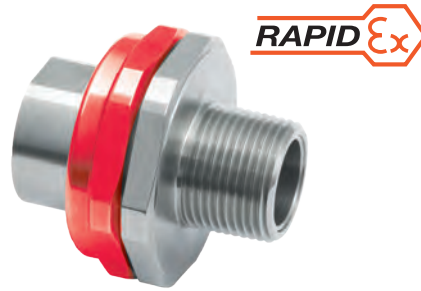

PX780REX



PX780REX In-Line Union, Globally Approved, Explosive Atmosphere Barrier Cable / Conduit Accessory

- RapidEx liquid pour sealing system
 - Enhances reliability, reduces risk
 - Reduces man hours
 - Reduces cost
- Allows the connection of conduit or glands to equipment
- Suitable for rigid or flexible conduit
- Integral coupling eliminates the need to rotate the conduit
- General Purpose / industrial version available
- Equipment interface 'O' ring seal available
- -60°C to +85°C
- Globally marked, IECEx, ATEX & cCSAus

Male-to-Male thread option available.

Available with an equipment interface 'O' ring seal. For such options please add the suffix letter "R" after the type number in the ordering reference above, e.g. PX780REXRDM2M2.

For epoxy compound version please remove "REX" from ordering reference.

If 2 separate enclosures are required to be connected together please contact CMP Products.

Technical Data

Design Specification	BS 6121:Part 1:1989, IEC 62444, EN 62444
Enclosure Protection	IK10 to IEC 62262 (20 joules) Brass & Stainless Steel only
ATEX Certification	SIRA10ATEX1306U
Code of Protection	⊕ II 2 GD Ex d IIC Gb, Ex e IIC Gb, Ex ta IIIC Da IP6X ⊕ IM2 Ex d I Mb / Ex e I Mb
Compliance Standards	EN 60079-0,1,7,31
IECEx Certificate	IECEx SIR 10.0148U
Code of Protection	Ex d IIC Gb, Ex e IIC Gb, Ex ta IIIC Da IP6X, Ex d I Mb, Ex e I Mb
Compliance Standards	IEC 60079-0,1,7,31
cCSAus Certificate	1055233
Code of Protection	Class I, Div 1 & 2, Groups A,B,C,D; Enclosure type 4X: Class I, Zone 1, AEx de II; Ex de II
Compliance Standards	C22.2 No.0,0,5,30,94, CAN/CSA E60079-0,1,7, CAN/CSA E612411, UL Std 50, 1203, UL 60079-0,1,7
EAC Certificate	TC RU C-GB.ГБ05.В00138
INMETRO Approval	TÜV 12.1334U
Ingress Protection Rating**	IP66
Available Materials	Brass (standard), Electroless Nickel Plated Brass, Aluminium, Stainless Steel

** When CMP installation accessories are used. Refer to page 7 or www.cmp-products.com for further information.

Product Selection Table

METRIC				NPT				Diameter Over Cores "C"	Max. Number of Cores	Protrusion Length "F"	Across Flats Hex "D"	Across Corners Ø "D"	Installation Torque (Nm)
Ordering Reference (Brass, Metric)	Male Forward Thread Size "A"	Minimum Thread Length "E"	Female Rear Thread Size "B"	Ordering Reference (Brass, NPT)	Male Forward NPT Thread Size "A"	Minimum NPT Thread Length "E" (in)	Female Rear Thread Size "B"						
PX780REXDM2M2	M20 X 1.5	15.0	M20 X 1.5	PX780REXDT1T1	½"	0.79	½"	12.6	11	36.0	46.0	50.6	7
PX780REXDM3M3	M25 X 1.5	15.0	M25 X 1.5	PX780REXDT2T2	¾"	0.80	¾"	17.5	21	36.0	50.0	55.0	10
PX780REXDM4M4	M32 X 1.5	15.0	M32 X 1.5	PX780REXDT3T3	1"	0.98	1"	23.6	38	36.0	60.0	66.0	15
PX780REXDM5M5	M40 X 1.5	15.0	M40 X 1.5	PX780REXDT4T4	1¼"	1.01	1¼"	30.0	59	36.0	65.0	71.5	25
PX780REXDM6M6	M50 X 1.5	15.0	M50 X 1.5	PX780REXDT5T5	1½"	1.03	1½"	41.0	89	36.0	75.0	82.5	30
PX780REXDM7M7	M63 X 1.5	15.0	M63 X 1.5	PX780REXDT6T6	2"	1.06	2"	53.7	115	36.0	90.2	99.2	45
PX780REXDM8M8	M75 X 1.5	15.0	M75 X 1.5	PX780REXDT7T7	2½"	1.57	2½"	64.3	140	39.0	99.3	109.2	45
PX780REXDM9M9	M90 X 2.0	24.0	M90 X 2.0	PX780REXDT8T8	3"	1.63	3"	75.3	200	42.0	120.0	132.0	45
PX780REXDM10M10	M100 X 2.0	24.0	M100 X 2.0	-	-	-	-	84.0	200	94.0	145.0	159.5	45

All dimensions shown are in millimetres unless otherwise stated

For material options please add the following suffix to the Ordering Reference; Brass (no suffix required), Nickel Plated Brass "5", 316 Grade Stainless Steel "4", Copper Free Aluminium "1"

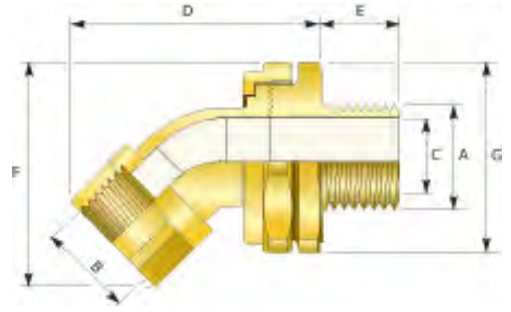

784



784 45° Union, Globally Approved, Explosive Atmosphere Cable / Conduit Accessory

- Allows the connection of conduit or glands to equipment
- Suitable for rigid or flexible conduit
- Integral coupling eliminates the need to rotate the conduit
- General Purpose / industrial version available
- Equipment interface 'O' ring seal available
- -60°C to 200°C
- Globally marked, IECEx, ATEX & cCSAus

Male-to-Male thread option available.

Available with an equipment interface 'O' ring seal. For such options please add the suffix letter "R" after the type number in the ordering reference above, e.g. 784RDM2M2.

If 2 separate enclosures are required to be connected together please contact CMP Products.

Technical Data

Design Specification	BS 6121:Part 1:1989, IEC 62444, EN 62444
Enclosure Protection	IK10 to IEC 62262 (20 joules) Brass & Stainless Steel only
ATEX Certification	SIRA10ATEX1306U
Code of Protection	⊕ II 2 GD Ex d IIC Gb, Ex e IIC Gb, Ex ta IIIC Da IP6X ⊕ IM2 Ex d I Mb / Ex e I Mb
Compliance Standards	EN 60079-0,1,7,31
IECEx Certificate	IECEx SIR 10.0148U
Code of Protection	Ex d IIC Gb, Ex e IIC Gb, Ex ta IIIC Da IP6X, Ex d I Mb, Ex e I Mb
Compliance Standards	IEC 60079-0,1,7,31
cCSAus Certificate	1055233
Code of Protection	Class I, Div 1 & 2, Groups A,B,C,D; Enclosure type 4X: Class I, Zone 1, AEx de II; Ex de II
Compliance Standards	C22.2 No.0,0.5,30,94, CAN/CSA E60079-0,1,7, CAN/CSA E612411, UL Std 50, 1203, UL 60079-0,1,7
EAC Certificate	TC RU C-GB.ГБ05.В00138
INMETRO Approval	TÜV 12.1334U
RETIE Approval	03866
Ingress Protection Rating**	IP66
Available Materials	Brass (standard), Electroless Nickel Plated Brass, Aluminium, Stainless Steel

** When CMP installation accessories are used. Refer to page 7 or www.cmp-products.com for further information.

Product Selection Table

Ordering Reference (Brass, Metric)	METRIC			NPT				Bore Diameter "C"	Max Protrusion Length "D"	Max Overhang Length "F"	Across Flats Hex "G"	Across Corners Ø "G"	Installation Torque (Nm)
	Male Forward Thread Size "A"	Minimum Thread Length "E"	Female Rear Thread Size "B"	Ordering Reference (Brass, NPT)	Male Forward NPT Thread Size "A"	Minimum NPT Thread Length "E" (in)	Female Rear Thread Size "B"						
784DM2M2	M20 X 1.5	15.0	M20 X 1.5	784DT1T1	½"	0.79	½"	14.3	60.6	55.8	46.0	50.6	7
784DM3M3	M25 X 1.5	15.0	M25 X 1.5	784DT2T2	¾"	0.80	¾"	20.1	65.9	61.2	50.0	55.0	10
784DM4M4	M32 X 1.5	15.0	M32 X 1.5	784DT3T3	1"	0.98	1"	26.4	69.3	69.7	60.0	66.0	15
784DM5M5	M40 X 1.5	15.0	M40 X 1.5	784DT4T4	1¼"	1.01	1¼"	32.6	74.9	76.4	65.0	71.5	25
784DM6M6	M50 X 1.5	15.0	M50 X 1.5	784DT5T5	1½"	1.03	1½"	43.0	93.5	87.9	75.0	82.5	30
784DM7M7	M63 X 1.5	15.0	M63 X 1.5	784DT6T6	2"	1.06	2"	53.0	102.7	102.8	90.2	99.2	45

All dimensions shown are in millimetres unless otherwise stated

For material options please add the following suffix to the Ordering Reference; Brass (no suffix required), Nickel Plated Brass "5", 316 Grade Stainless Steel "4", Copper Free Aluminium "1"

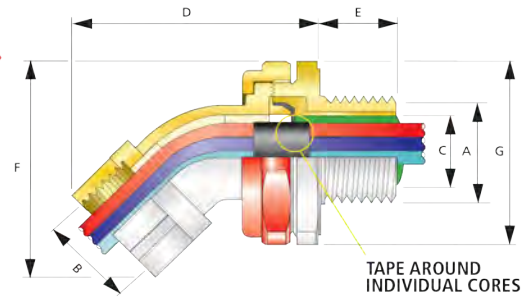
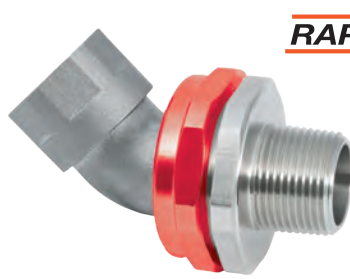

PX784REX



PX784REX 45° Union, Globally Approved, Explosive Atmosphere Barrier Cable / Conduit Accessory

- RapidEx liquid pour sealing system
 - Enhances reliability, reduces risk
 - Reduces man hours
 - Reduces cost
- Allows the connection of conduit or glands to equipment
- Suitable for rigid or flexible conduit
- Integral coupling eliminates the need to rotate the conduit
- General Purpose / industrial version available
- Equipment interface 'O' ring seal available
- -60°C to +85°C
- Globally marked, IECEX, ATEX & cCSAus

Male-to-Male thread option available.

Available with an equipment interface 'O' ring seal. For such options please add the suffix letter "R" after the type number in the ordering reference above, e.g. PX784REXDM2M2.

For epoxy compound version please remove "REX" from ordering reference.

If 2 separate enclosures are required to be connected together please contact CMP Products.

Technical Data

Design Specification	BS 6121:Part 1:1989, IEC 62444, EN 62444
Enclosure Protection	IK10 to IEC 62262 (20 joules) Brass & Stainless Steel only
ATEX Certification	SIRA10ATEX1306U
Code of Protection	Ⓜ II 2 GD Ex d IIC Gb, Ex e IIC Gb, Ex ta IIIC Da IP6X Ⓜ IM2 Ex d I Mb / Ex e I Mb
Compliance Standards	EN 60079-0,1,7,31
IECEX Certificate	IECEX SIR 10.0148U
Code of Protection	Ex d IIC Gb, Ex e IIC Gb, Ex d I Mb, Ex e I Mb, Ex ta IIIC Da IP6X
Compliance Standards	IEC 60079-0,1,7,31
cCSAus Certificate	1055233
Code of Protection	Class I, Div 1 & 2, Groups A,B,C,D ; Enclosure type 4X : Class I, Zone 1, AEx de II ; Ex de II
Compliance Standards	C22.2 No.0.0.5,30,94, CAN/CSA E60079-0,1,7, CAN/CSA E612411, UL Std 50, 1203, UL 60079-0,1,7
EAC Certificate	TC RU C-GB.ГБ05.В00138
INMETRO Approval	TÜV 12.1334U
RETIE Approval	03866
Ingress Protection Rating**	IP66
Available Materials	Brass (standard), Electroless Nickel Plated Brass, Aluminium, Stainless Steel

** When CMP installation accessories are used. Refer to page 7 or www.cmp-products.com for further information.

Product Selection Table

METRIC				NPT				Diameter over Cores "C"	Max. number of Cores	Max. Protrusion Length "D"	Max. Overhang Length "F"	Across Flats Hex "G"	Across Corners Ø "G"	Installation Torque (Nm)
Ordering Reference (Brass, Metric)	Male Forward Thread Size "A"	Minimum Thread Length "E"	Female Rear Thread Size "B"	Ordering Reference (Brass, NPT)	Male Forward NPT Thread Size "A"	Minimum NPT Thread Length "E" (in)	Female Rear Thread Size "B"							
PX784REXDM2M2	M20 X 1.5	15.0	M20 X 1.5	PX784REXDT1T1	½"	0.79	½"	12.6	11	60.6	55.8	46.0	50.6	7
PX784REXDM3M3	M25 X 1.5	15.0	M25 X 1.5	PX784REXDT2T2	¾"	0.80	¾"	17.5	21	65.9	61.2	50.0	55.0	10
PX784REXDM4M4	M32 X 1.5	15.0	M32 X 1.5	PX784REXDT3T3	1"	0.98	1"	23.6	38	69.5	70.2	60.0	66.0	15
PX784REXDM5M5	M40 X 1.5	15.0	M40 X 1.5	PX784REXDT4T4	1¼"	1.01	1¼"	30.0	59	74.9	76.4	65.0	71.5	25
PX784REXDM6M6	M50 X 1.5	15.0	M50 X 1.5	PX784REXDT5T5	1½"	1.03	1½"	41.0	89	93.5	88.0	75.0	82.5	30
PX784REXDM7M7	M63 X 1.5	15.0	M63 X 1.5	PX784REXDT6T6	2"	1.06	2"	53.7	115	102.7	103.4	90.2	99.2	45

All dimensions shown are in millimetres unless otherwise stated

For material options please add the following suffix to the Ordering Reference; Brass (no suffix required), Nickel Plated Brass "5", 316 Grade Stainless Steel "4", Copper Free Aluminium "1"

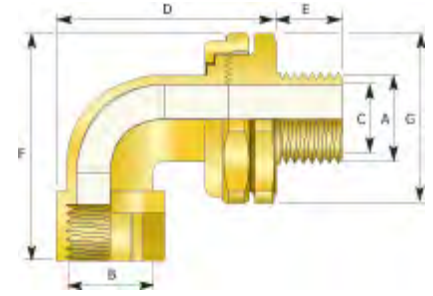

789



789 90° Union, Globally Approved, Explosive Atmosphere Cable / Conduit Accessory

- Allows the connection of conduit or glands to equipment
- Suitable for rigid or flexible conduit
- Integral coupling eliminates the need to rotate the conduit
- General Purpose / industrial version available
- Equipment interface 'O' ring seal available
- -60°C to 200°C
- Globally marked, IECEx, ATEX & cCSAus

Male-to-Male thread option available.

Available with an equipment interface 'O' ring seal. For such options please add the suffix letter "R" after the type number in the ordering reference above, e.g. 789RDM2M2.

If 2 separate enclosures are required to be connected together please contact CMP Products.

Technical Data

Design Specification	BS 6121:Part 1:1989, IEC 62444, EN 62444
Enclosure Protection	IK10 to IEC 62262 (20 joules) Brass & Stainless Steel only
ATEX Certification	SIRA10ATEX1306U
Code of Protection	Ⓜ II 2 GD Ex d IIC Gb, Ex e IIC Gb, Ex ta IIIC Da IP6X Ⓜ IM2 Ex d I Mb / Ex e I Mb
Compliance Standards	EN 60079-0,1,7,31
IECEx Certificate	IECEx SIR 10.0148U
Code of Protection	Ex d IIC Gb, Ex e IIC Gb, Ex d I Mb, Ex e I Mb, Ex ta IIIC Da IP6X
Compliance Standards	IEC 60079-0,1,7,31
cCSAus Certificate	1055233
Code of Protection	Class I, Div 1 & 2, Groups A,B,C,D ; Enclosure type 4X : Class I, Zone 1, AEx de II ; Ex de II
Compliance Standards	C22.2 No.0,0.5,30,94, CAN/CSA E60079-0,1,7, CAN/CSA E612411, UL Std 50, 1203, UL 60079-0,1,7
EAC Certificate	TC RU C-GB.ГБ05.В00138
INMETRO Approval	TÜV 12.1334U
RETIE Approval	03866
Ingress Protection Rating**	IP66
Available Materials	Brass (standard), Electroless Nickel Plated Brass, Aluminium, Stainless Steel

** When CMP installation accessories are used. Refer to page 7 or www.cmp-products.com for further information.

Product Selection Table

METRIC				NPT				Bore Diameter "C"	Max Protrusion Length "D"	Max Overhang Length "F"	Across Flats Hex "G"	Across Corners Ø "G"	Installation Torque (Nm)	Weight (kgs)
Ordering Reference (Brass, Metric)	Male Forward Thread Size "A"	Minimum Thread Length "E"	Female Rear Thread Size "B"	Ordering Reference (Brass, NPT)	Male Forward NPT Thread Size "A"	Minimum NPT Thread Length "E" (in)	Female Rear Thread Size "B"							
789DM2M2	M20 X 1.5	15.0	M20 X 1.5	789DT1T1	½"	0.79	½"	14.3	62.9	63.8	46.0	50.6	7	0.35
789DM3M3	M25 X 1.5	15.0	M25 X 1.5	789DT2T2	¾"	0.80	¾"	20.1	70.6	69.5	50.0	55.0	10	0.45
789DM4M4	M32 X 1.5	15.0	M32 X 1.5	789DT3T3	1"	0.98	1"	26.4	75.7	78.0	60.0	66.0	15	0.59
789DM5M5	M40 X 1.5	15.0	M40 X 1.5	789DT4T4	1¼"	1.01	1¼"	32.6	83.7	84.8	65.0	71.5	25	0.74
789DM6M6	M50 X 1.5	15.0	M50 X 1.5	789DT5T5	1½"	1.03	1½"	43.0	95.9	96.3	75.0	82.5	30	1.05
789DM7M7	M63 X 1.5	15.0	M63 X 1.5	789DT6T6	2"	1.06	2"	55.0	108.8	115.1	90.2	99.2	45	1.52

All dimensions shown are in millimetres unless otherwise stated

For material options please add the following suffix to the Ordering Reference; Brass (no suffix required), Nickel Plated Brass "5", 316 Grade Stainless Steel "4", Copper Free Aluminium "1"

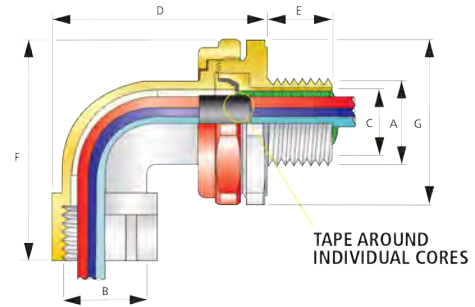

PX789REX



PX789REX 90° Union, Globally Approved, Explosive Atmosphere Barrier Cable / Conduit Accessory

- RapidEx liquid pour sealing system
 - Enhances reliability, reduces risk
 - Reduces man hours
 - Reduces cost
- Allows the connection of conduit or glands to equipment
- Suitable for rigid or flexible conduit
- Integral coupling eliminates the need to rotate the conduit
- General Purpose / industrial version available
- Equipment interface 'O' ring seal available
- -60°C to +85°C
- Globally marked, IECEx, ATEX & cCSAus

Male-to-Male thread option available.

Available with an equipment interface 'O' ring seal. For such options please add the suffix letter "R" after the type number in the ordering reference above, e.g. PX789REXRDM2M2.

For epoxy compound version please remove "REX" from ordering reference.

If 2 separate enclosures are required to be connected together please contact CMP Products.

Technical Data

Design Specification	BS 6121:Part 1:1989, IEC 62444, EN 62444
Enclosure Protection	IK10 to IEC 62262 (20 joules) Brass & Stainless Steel only
ATEX Certification	SIRA10ATEX1306U
Code of Protection	⊕ II 2 GD Ex d IIC Gb, Ex e IIC Gb, Ex ta IIIC Da IP6X ⊕ IM2 Ex d I Mb / Ex e I Mb
Compliance Standards	EN 60079-0,1,7,31
IECEx Certificate	IECEx SIR 10.0148U
Code of Protection	Ex d IIC Gb, Ex e IIC Gb, Ex d I Mb, Ex e I Mb, Ex ta IIIC Da IP6X
Compliance Standards	IEC 60079-0,1,7,31
cCSAus Certificate	1055233
Code of Protection	Class I, Div 1 & 2, Groups A,B,C,D; Enclosure type 4X: Class I, Zone 1, AEx de II; Ex de II
Compliance Standards	C22.2 No.0,0,5,30,94, CAN/CSA E60079-0,1,7, CAN/CSA E612411, UL Std 50, 1203, UL 60079-0,1,7
EAC Certificate	TC RU C-GB.ГБ05.В00138
INMETRO Approval	TÜV 12.1334U
RETIE Approval	03866
Ingress Protection Rating**	IP66
Available Materials	Brass (standard), Electroless Nickel Plated Brass, Aluminium, Stainless Steel

** When CMP installation accessories are used. Refer to page 7 or www.cmp-products.com for further information.

Product Selection Table

METRIC				NPT				Diameter over Cores "C"	Max. number of Cores	Max. Protrusion Length "D"	Max. Overhang Length "F"	Across Flats Hex "G"	Across Corners Ø "G"	Installation Torque (Nm)
Ordering Reference (Brass, Metric)	Male Forward Thread Size "A"	Minimum Thread Length "E"	Female Rear Thread Size "B"	Ordering Reference (Brass, NPT)	Male Forward NPT Thread Size "A"	Minimum NPT Thread Length "E" (in)	Female Rear Thread Size "B"							
PX789REXDM2M2	M20 X 1.5	15.0	M20 X 1.5	PX789REXDT1T1	½"	0.79	½"	12.6	11	62.9	63.8	46.0	50.6	7
PX789REXDM3M3	M25 X 1.5	15.0	M25 X 1.5	PX789REXDT2T2	¾"	0.80	¾"	17.5	21	70.6	69.5	50.0	55.0	10
PX789REXDM4M4	M32 X 1.5	15.0	M32 X 1.5	PX789REXDT3T3	1"	0.98	1"	23.6	38	75.7	78.0	60.0	66.0	15
PX789REXDM5M5	M40 X 1.5	15.0	M40 X 1.5	PX789REXDT4T4	1¼"	1.01	1¼"	30.0	59	83.7	84.8	65.0	71.5	25
PX789REXDM6M6	M50 X 1.5	15.0	M50 X 1.5	PX789REXDT5T5	1½"	1.03	1½"	41.0	89	95.9	96.3	75.0	82.5	30
PX789REXDM7M7	M63 X 1.5	15.0	M63 X 1.5	PX789REXDT6T6	2"	1.06	2"	53.7	115	108.8	115.1	90.2	99.2	45

All dimensions shown are in millimetres unless otherwise stated

For material options please add the following suffix to the Ordering Reference; Brass (no suffix required), Nickel Plated Brass "5", 316 Grade Stainless Steel "4", Copper Free Aluminium "1"

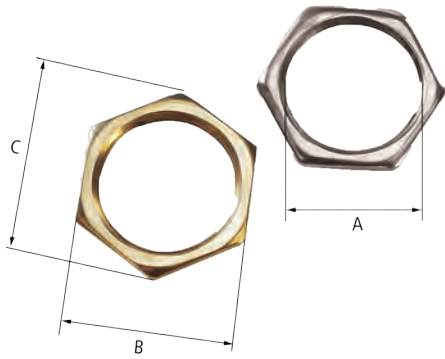

METRIC - LOCKNUTS				
Ordering Reference (Brass)	Thread Diameter "A"	Minimum Thickness	Across Flats Dimension "B"	Across Corners Diameter "C"
16LN	M16 X 1.5	3.2	22.0	25.4
16HLN	M16 X 1.5	5.0	22.0	25.4
20LN	M20 X 1.5	3.2	24.0	27.7
20HLN	M20 X 1.5	5.0	24.0	27.7
25LN	M25 X 1.5	3.2	30.0	34.6
25HLN	M25 X 1.5	5.0	30.0	34.6
32LN	M32 X 1.5	3.2	36.0	41.6
32HLN	M32 X 1.5	5.0	36.0	41.6
40LN	M40 X 1.5	4.8	46.0	53.1
50LN	M50 X 1.5	6.3	55.0	63.5
63LN	M63 X 1.5	6.3	70.0	80.8
75LN	M75 X 1.5	6.3	84.0	97.0
90LN	M90 X 2.0	9.5	106.0	122.4
100LN	M100 X 2.0	9.5	123.0	142.0

All dimension shown are in millimetres unless otherwise stated

Locknuts

Brass - Recommended in securing brass Cable Glands and Accessories to a gland plate or into equipment. In metric thread form CMP offers brass locknuts in a choice of standard duty and heavy duty options for sizes up to and including M32. The part numbers are distinguished by an additional letter H, e.g. 20LN = standard duty, and 20HLN = heavy duty. From size M40 all brass metric locknuts are considered to be heavy duty.

Zinc Plated Mild Steel - A cost effective alternative to brass locknuts and should be used only in dry, low humidity conditions.

Aluminium - Recommended when installing aluminium Cable Glands to prevent the galvanic corrosion which can occur when dissimilar metals are coupled together.

Stainless Steel - Corrosion resistant with increased strength at high temperatures.

Please refer to ordering reference numbers (page 150), e.g. 20LN4 for M20 Stainless Steel Locknut, 050NPTLN4 for 1/2" NPT Stainless Steel Locknut.

NPT - LOCKNUTS				
Ordering Reference (Brass)	Thread Diameter "A"	Minimum Thickness	Across Flats Dimension "B"	Across Corners Diameter "C"
050NPTLN	1/2" NPT	4.8	27.0	31.2
075NPTLN	3/4" NPT	4.8	33.0	38.1
100NPTLN	1" NPT	4.8	41.0	47.3
125NPTLN	1 1/4" NPT	4.8	50.0	57.7
150NPTLN	1 1/2" NPT	5.0	60.0	69.3
200NPTLN	2" NPT	5.0	75.0	88.6
250NPTLN	2 1/2" NPT	10.0	84.0	97.0
300NPTLN	3" NPT	10.0	100.0	115.5
350NPTLN	3 1/2" NPT	11.2	114.3	132.0
400NPTLN	4" NPT	12.0	130.0	150.1

All dimension shown are in millimetres unless otherwise stated

Serrated Washers

Available in Stainless Steel, these 'shake-proof' Serrated Washers are fitted internally to the equipment before a locknut and act as an anti-vibration device to prevent the Cable Gland or accessory from inadvertently loosening in service.

In typical installations that are not subject to vibration, a serrated washer may not be required but consideration should be given to the following statement:

Self-loosening should be avoided according to clause 6.4.1 of IEC 60079-14, this can occur through relative motion over time even without vibration, due to differential thermal effects caused as a result of either differences in temperature or differences in clamped materials.

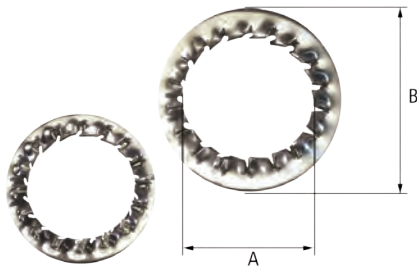

METRIC - SERRATED WASHERS			
Ordering Reference (Stainless Steel)	Reference Diameter "A"	Minimum Thickness	External Diameter "B"
16SW4	M16	3.9	25.5
20SW4	M20	3.9	32.5
25SW4	M25	3.9	40.0
32SW4	M32	3.9	43.5
40SW4	M40	3.9	64.5
50SW4	M50	3.9	80.0
63SW4	M63	3.9	100.0
75SW4	M75	4.1	112.0
90SW4	M90	4.1	135.0
100SW4	M100	4.1	145.0

All dimension shown are in millimetres unless otherwise stated

NPT - SERRATED WASHERS			
Ordering Reference (Stainless Steel)	Reference Diameter "A"	Minimum Thickness	External Diameter "B"
050NPTSW4	1/2" NPT	3.9	32.5
075NPTSW4	3/4" NPT	3.9	40.0
100NPTSW4	1" NPT	3.9	43.5
125NPTSW4	1 1/4" NPT	3.9	64.5
150NPTSW4	1 1/2" NPT	3.9	80.0
200NPTSW4	2" NPT	3.9	100.0
250NPTSW4	2 1/2" NPT	3.9	112.0
300NPTSW4	3" NPT	4.1	135.0
350NPTSW4	3 1/2" NPT	4.1	145.0
400NPTSW4	4" NPT	4.1	185.0

All dimension shown are in millimetres unless otherwise stated



Earth Tags

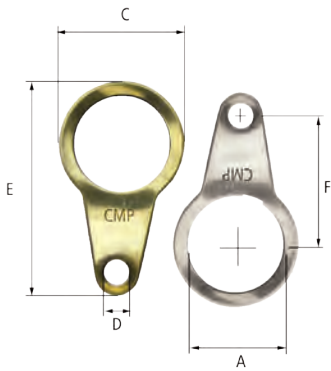

CMP Earth Tag Size	Short Circuit Ratings Symmetrical Fault Current (kA) for 1 second
20	3.06
25	4.06
32	5.40
40	7.20
50	10.40
63	10.40
75	10.40

CMP slip on Earth Tags, installed between the Cable Gland and equipment, provide an earth bond connection as specified in BS6121:Part 5:1993 and comply with category B rating specified in IEC 62444. CMP Earth Tags have been independently short circuit tested to verify their suitability under specified service conditions. A copy of the test report is available upon request and is an important factor when selecting earth tags from any manufacturer, as without this the safety of installations may be compromised.

Stainless steel, aluminium and nickel plated brass earth tags are also available. Please refer to ordering reference numbers (page 150), e.g 20ET4 for M20 Stainless Steel Earth Tag, 050NPTET4 for 1/2" NPT Stainless Steel Earth Tag.

METRIC - EARTH TAGS

Ordering Reference (Brass)	Reference Diameter "A"	Minimum Thickness	Nominal Diameter "C"	Hole Size "D"	Nominal Length "E"	Nominal Centres "F"
16ET	M16	1.3	25.4	M6	50.3	30.2
20ET	M20	1.3	27.2	M6	52.3	33.0
25ET	M25	1.5	35.1	M6	59.2	35.6
32ET	M32	1.5	45.2	M12	77.0	43.2
40ET	M40	1.5	53.6	M13	88.6	45.5
50ET	M50	1.5	65.3	M13	111.3	58.2
63ET	M63	1.5	82.6	M13	128.8	66.8
75ET	M75	1.5	95.5	M13	141.5	72.9
90ET	M90	2.0	114.3	M13	161.0	85.1
100ET	M100	2.0	125.0	M13	194.8	118.1

All dimension shown are in millimetres unless otherwise stated

NPT - EARTH TAGS

Ordering Reference (Brass)	Reference Diameter "A"	Minimum Thickness	Nominal Diameter "C"	Hole Size "D"	Nominal Length "E"	Nominal Centres "F"
050NPTET	1/2" NPT	1.3	27.2	M6	52.8	33.0
075NPTET	3/4" NPT	1.5	35.1	M6	59.2	35.6
100NPTET	1" NPT	1.5	45.2	M12	77.0	43.2
125NPTET	1 1/4" NPT	1.5	53.6	M13	88.6	45.5
150NPTET	1 1/2" NPT	1.5	65.3	M13	111.3	58.2
200NPTET	2" NPT	1.5	82.6	M13	128.8	66.8
250NPTET	2 1/2" NPT	1.5	95.5	M13	141.5	72.9
300NPTET	3" NPT	2.0	114.0	M13	161.0	85.1
350NPTET	3 1/2" NPT	2.0	125.0	M13	194.8	103.1
400NPTET	4" NPT	2.0	140.5	M13	207.0	117.9

All dimension shown are in millimetres unless otherwise stated

Product Code	CMP TMC2X Cable Gland Size	CMP PX Cable Gland Size	Connection Thread Size
IGWS	TMC2X-XXXX075	20S	M20 or 1/2" NPT
	TMC2X-XXXX099	20	M20 or 1/2" NPT
	TMC2X-XXXX118	25	M25 or 3/4" NPT
IGWM	TMC2X-XXXX137	32	M32 or 1" NPT
	TMC2X-XXXX162	40	M40 or 1 1/4" NPT
	TMC2X-XXXX190	50S	M50 or 1 1/2" NPT
	TMC2X-XXXX200	50	M50 or 2" NPT
IGWL	TMC2X-XXXX233	63S	M63 or 2" NPT
	-	63	M63 or 2 1/2" NPT
	TMC2X-XXXX272	75S	M75 or 2 1/2" NPT
	TMC2X-XXXX325	75	M75 or 3" NPT
	TMC2X-XXXX376	90	M90 or 3 1/2" NPT
	TMC2X-XXXX425	100	M100 or 4" NPT

Cable Gland Warmer

Where it is not possible to erect a shelter for the application of epoxy compound or RapidEx liquid resin it is recommended that a CMP Cable Gland Warmer be used for localised heating of barrier type Cable Glands.

CMP Cable Gland Warmers may be used when installers do not have access to hot air guns. Similarly when electrical power is not available on site enabling electric heating blankets to be used, or the site conditions do not permit their use.

CMP Cable Gland Warmers comprise a self-contained heat pack which has been designed to completely enclose any of the CMP RapidEx Barrier Cable Gland range. The Cable Gland Warmer operates using crystallisation of supersaturated sodium acetate to raise the temperature of the Cable Gland up to 60°C (140°F) and is only suitable for use with RapidEx liquid resin.

As the Cable Gland Warmer releases heat for a limited time, it is important that they are used in the most effective manner; this involves wrapping the Cable Gland Warmer around the Cable Gland so that heat is transferred directly. This will ensure that the barrier tube, where the RapidEx liquid resin will be poured, is suitably prepared and ready for use.

For use in environments between -10°C (14°F) to +5°C (41°F)

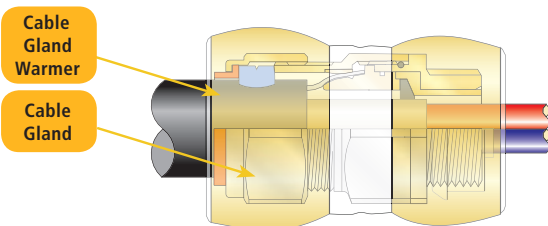

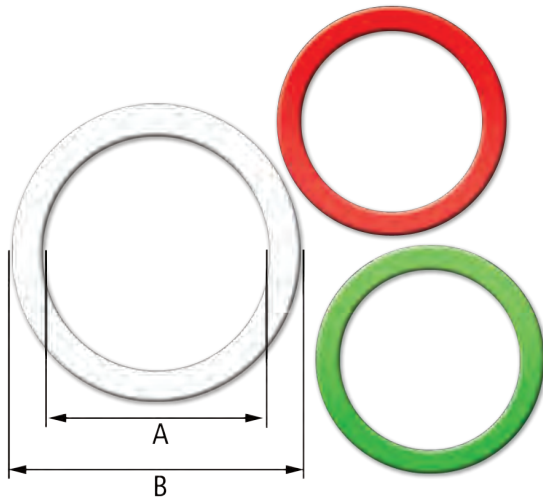

- Green Nylon Entry Thread Sealing Washers for NPT Threads
- White Nylon Entry Thread Sealing Washers for Metric Threads
- Red Fibre Entry Thread Sealing Washers for Metric Threads

Entry Thread Sealing Washers

To maintain the Ingress Protection rating between the equipment and the Cable Gland, it may be necessary to fit an Entry Thread Sealing Washer at the equipment-to-gland entry interface. For installations it is equally essential to maintain the ingress protection integrity at which the equipment has been rated.

The need for a sealing washer will depend on the ingress protection rating, code of protection of the equipment and the type of entry holes available within that equipment. For example, when using Ex e equipment or terminal enclosures (which are permitted to have untapped through-clearance holes) it will be necessary to fit a sealing washer to ensure the minimum IP54 requirement is met. Other equipment with tapped entry holes may not require a sealing washer to maintain the IP54 minimum rating.

The CMP metric Entry Thread Sealing Washers are produced in 2mm thick white nylon as standard which are recommended and meet the specified requirements of Shell's Offshore operations. To verify the effectiveness of the CMP nylon entry sealing washers, independent 3rd party tests to IEC 60529 have been successfully conducted on Cable Gland at IP66, IP67 and IP68 levels of protection, documentary evidence of such tests to the highest standards can be provided.

CMP NPT Entry Thread Sealing Washers are produced in 2mm thick nylon and are colour coded Green for identification purposes.

Red Fibre Washers can also be supplied to order but careful consideration should be given to their use in sub-zero climates where absorption, freezing and cracking may occur. These red fibre washers can be ordered by substituting 'ETS' with 'FW' in the below tables.

CMP also offers Cable Glands and accessories with an equipment interface 'O' ring seal as an alternative.

WHITE METRIC ENTRY THREAD SEALING WASHERS			
Ordering Reference	Reference Diameter "A"	Minimum Thickness	External Diameter "B"
16ETS2	M16	2.0	25.4
20ETS2	M20	2.0	28.0
25ETS2	M25	2.0	34.4
32ETS2	M32	2.0	44.1
40ETS2	M40	2.0	50.5
50ETS2	M50	2.0	63.4
63ETS2	M63	2.0	76.5
75ETS2	M75	2.0	95.0
90ETS2	M90	2.0	110.0

All dimension shown are in millimetres unless otherwise stated

GREEN NPT ENTRY THREAD SEALING WASHERS			
Ordering Reference	Reference Diameter "A"	Minimum Thickness	External Diameter "B"
050NPTETS	½" NPT	2.0	28.0
075NPTETS	¾" NPT	2.0	34.4
100NPTETS	1" NPT	2.0	44.1
125NPTETS	1 ¼" NPT	2.0	50.5
150NPTETS	1 ½" NPT	2.0	63.4
200NPTETS	2" NPT	2.0	76.5
250NPTETS	2 ½" NPT	2.0	95.0
300NPTETS	3" NPT	2.0	110.0
400NPTETS	4" NPT	2.0	136.7

All dimension shown are in millimetres unless otherwise stated



Armour Former

When installing Cable Glands it is vital that the correct tools are used to carry out the installation.

Fabricated CMP products high quality speciality steel. This is a precision tool for terminating Single Wire Armour (SWA) cables correctly first time every time. Simply bend and form the armour wires using this tool in one quick, simple motion and crimp and terminate your CMP armoured Cable Gland.

ARMOUR FORMER	
Armour Diameter	Ordering Reference
1.6 - 4.0mm	AFT02



Cable Gland Spanners

When installing Cable Glands and accessories it is important that the correct tools are used to carry out the installation.

This includes the use of the correct Cable Gland Spanner specifically designed to fit each individual product to minimise the potential for accidental injury caused by slippage, as can be the case with adjustable spanners or wrenches.

NPT												
SIZE	TMC / TMCX		SIZE	TMC2		TMC2X		SIZE	TMC2		TMC2X	
	Spanner 1	Spanner 2		Spanner 1	Spanner 2	Spanner 1	Spanner 2		Spanner 1	Spanner 2	Spanner 1	Spanner 2
05S	SP04	SP04	205-1/2"	SP04	SP04	SP04	SP04	50-1 1/2"	SP21	SP19	SP21	SP19
050	SP09	SP09	205-3/4"	SP07	SP04	SP04	SP04	635-2"	SP21	SP20	SP21	SP20
075	SP12	SP12	20-3/8"	SP07	SP07	SP07	SP07	635-2 1/2"	SP24	SP20	SP24	SP20
100	SP15	SP15	20-3/8"	SP07	SP07	SP07	SP07	63-2"	SP24	SP21	SP24	SP21
125	SP14	SP14	25-3/8"	SP13	SP13	SP13	SP13	75-2 1/2"	SP24	SP24	SP24	SP24
150	SP18	SP18	25-1"	SP13	SP13	SP13	SP13	75-3"	SP26	SP24	SP26	SP24
20S	SP20	SP20	32-1"	SP16	SP16	SP16	SP16	90-3"	SP26	SP26	SP26	SP26
200	SP21	SP21	32-1 1/4"	SP16	SP16	SP16	SP16	90-3 1/2"	SP36	SP26	SP26	SP26
25S	SP22	SP22	405-1 1/4"	SP18	SP18	SP18	SP18	100-3 1/2"	SP36	SP36	SP25	SP36
250	SP23	SP23	405-1 1/2"	SP18	SP18	SP18	SP18	100-4"	SP30	SP36	SP36	SP36
300	SP26	SP26	40-1 1/4"	SP19	SP18	SP19	SP18	115-4"	SP30	SP30	SP30	SP30
350	SP30	SP30	40-1 1/4"	SP19	SP18	SP19	SP18					
400	SP30	SP30	505-1 1/2"	SP20	SP19	SP20	SP19					

METRIC																				
SIZE	A**		BW		C**			E**			SS2K		T3CDS / TE1FU			PXSS2K			C2K / PX**	
	Spanner 1	Spanner 2	Spanner 1	Spanner 2	Spanner 1	Spanner 2	Spanner 3	Spanner 1	Spanner 2	Spanner 3	Spanner 1	Spanner 2	Spanner 1	Spanner 2	Spanner 3	Spanner 1	Spanner 2	Spanner 3	Spanner 1	Spanner 2
20S16	SP03	SP01	-	-	-	-	-	-	-	-	SP03	SP03	SP01	SP03	SP03	-	-	-	-	-
20S	SP03	SP01	SP03	SP01	SP03	SP03	SP03	SP03	SP03	SP03	SP03	SP03	SP01	SP03	SP03	SP06	SP03	SP04	SP04	SP04
20	SP06	SP06	SP05	SP05	SP06	SP06	SP04	SP06	SP06	SP06	SP06	SP06	SP03	SP04	SP04	SP06	SP06	SP04	SP04	SP04
25 & 25S	SP09	SP09	SP08	SP08	SP09	SP09	SP07	SP09	SP09	SP07	SP09	SP09	SP07	SP07	SP07	SP09	SP09	SP07	SP07	SP07
32	SP12	SP12	SP12	SP12	SP12	SP13	SP13	SP12	SP12	SP13	SP12	SP12	SP07	SP13	SP13	SP12	SP12	SP13	SP13	SP13
40	SP15	SP13	SP15	SP15	SP15	SP14	SP14	SP15	SP15	SP14	SP15	SP15	SP13	SP14	SP14	SP15	SP15	SP14	SP14	SP14
50S	SP14	SP14	SP17	SP17	SP18	SP18	SP18	SP14	SP18	SP18	SP14	SP14	SP16	SP18	SP18	SP14	SP14	SP18	SP18	SP18
50	SP18	SP18	SP19	SP19	SP19	SP20	SP20	SP18	SP19	SP20	SP18	SP18	SP18	SP20	SP20	SP18	SP18	SP20	SP20	SP20
63S	SP20	SP19	SP20	SP21	SP20	SP21	SP21	SP20	SP20	SP21	SP20	SP20	SP19	SP21	SP21	SP20	SP20	SP21	SP21	SP21
63	SP21	SP20	SP39	SP22	SP39	SP22	SP22	SP21	SP39	SP22	SP21	SP21	SP20	SP22	SP22	SP21	SP21	SP22	SP22	SP22
75S	SP23	SP22	SP23	SP24	SP24	SP24	SP24	SP23	SP24	SP24	SP23	SP22	SP22	SP24	SP24	SP22	SP22	SP24	SP24	SP24
75	SP23	SP23	SP24	SP34	SP25	SP25	SP25	SP23	SP25	SP25	SP23	SP23	SP23	SP25	SP25	SP23	SP23	SP25	SP25	SP25
90	SP35	SP35	SP26	SP26	SP27	SP27	SP27	SP35	SP27	SP27	SP35	SP35	SP25	SP27	SP27	SP35	SP35	SP27	SP27	SP27
100	SP36	SP27	-	-	SP36	SP36	SP36	SP36	SP36	SP36	SP36	SP36	SP26	SP29	SP36	SP36	SP36	SP29	SP29	SP29
115	SP30	SP37	-	-	SP30	SP30	SP30	SP30	SP30	SP30	SP30	SP30	SP28	SP31	SP30	-	-	-	-	-
130	SP38	SP38	-	-	SP38	SP38	SP38	SP38	SP38	SP38	SP38	SP38	SP32	SP38	SP38	-	-	-	-	-

NPT																								
SIZE	A**		C**			E**			SS2K			T3CDS / TE1FU				PXSS2K			C2K / PX**			TC		
	Spanner 1	Spanner 2	Spanner 1	Spanner 2	Spanner 3	Spanner 1	Spanner 2	Spanner 3	Spanner 1	Spanner 2	Spanner 3	Spanner 1	Spanner 2	Spanner 3	Spanner 4	Spanner 1	Spanner 2	Spanner 3	Spanner 1	Spanner 2	Spanner 3	Spanner 1	Spanner 2	
20S16	1/2"	SP03	SP01	-	-	SP03	-	-	SP03	SP03	SP03	SP03	SP01	SP03	SP03	-	-	-	-	-	-	-	-	-
	3/4"	SP04	SP01	-	-	SP04	-	-	SP04	SP03	SP03	SP07	SP01	SP03	SP03	-	-	-	-	-	-	-	-	-
20S	1/2"	SP03	SP01	SP03	SP03	SP03	SP03	SP03	SP03	SP03	SP03	SP01	SP03	SP03	SP04	SP06	SP03	-	-	-	SP04	SP04	SP04	SP04
	3/4"	SP06	SP01	SP06	SP03	SP06	SP03	SP03	SP06	SP06	SP06	SP07	SP01	SP03	SP03	SP04	SP06	SP03	-	-	-	SP07	SP04	
20	1/2"	SP06	SP06	SP04	SP06	SP06	SP06	SP06	SP06	SP06	SP06	SP03	SP04	SP04	SP04	SP06	SP06	SP04	SP04	SP04	SP04	SP04	SP04	
	3/4"	SP04	SP06	SP04	SP06	SP04	SP04	SP06	SP04	SP04	SP06	SP06	SP04	SP03	SP04	SP04	SP04	SP06	SP06	SP04	SP04	SP04	SP07	
25 & 25S	3/4"	SP09	SP09	SP09	SP09	SP07	SP09	SP09	SP07	SP09	SP09	SP09	SP07	SP07	SP07	SP09	SP09	SP09	SP07	SP07	SP07	SP07	SP07	
	1"	SP11	SP09	SP09	SP09	SP07	SP11	SP09	SP07	SP11	SP09	SP09	SP07	SP07	SP07	SP09	SP09	SP09	SP07	SP07	SP07	SP13	SP07	
32	1"	SP12	SP12	SP12	SP13	SP12	SP13	SP13	SP12	SP12	SP13	SP07	SP13	SP13	SP12	SP12	SP12	SP13	SP13	SP13	SP13	SP13	SP13	
	1 1/4"	SP13	SP12	SP13	SP13	SP13	SP13	SP13	SP12	SP12	SP13	SP07	SP13	SP13	SP13	SP12	SP12	SP12	SP13	SP13	SP13	SP13	SP16	
40	1 1/4"	SP15	SP13	SP15	SP14	SP14	SP15	SP14	SP14	SP15	SP15	SP15	SP14	SP13	SP14	SP14	SP15	SP15	SP15	SP14	SP14	SP14	SP16	
	1 1/2"	SP15	SP13	SP15	SP14	SP14	SP15	SP14	SP14	SP15	SP15	SP15	SP14	SP13	SP14	SP14	SP15	SP15	SP15	SP14	SP14	SP14	SP18	
50S	1 1/2"	SP14	SP14	SP18	SP18	SP18	SP14	SP18	SP18	SP14	SP14	SP18	SP16	SP18	SP18	SP14	SP14	SP14	SP18	SP18	SP18	SP18	SP18	
	2"	SP19	SP14	SP19	SP18	SP18	SP19	SP18	SP18	SP19	SP14	SP14	SP19	SP16	SP18	SP18	SP19	SP14	SP14	SP18	SP18	SP18	SP18	
50	2"	SP19	SP18	SP19	SP20	SP20	SP19	SP20	SP20	SP19	SP18	SP18	SP20	SP18	SP20	SP20	SP20	SP20	SP20	SP20	SP20	SP20	SP20	
	2 1/2"	SP22	SP18	SP21	SP20	SP20	SP22	SP20	SP20	SP22	SP18	SP18	SP22	SP18	SP20	SP20	SP22	SP18	SP18	SP22	SP20	SP20	SP24	
63S	2"	SP20	SP19	SP20	SP21	SP21	SP20	SP21	SP21	SP20	SP20	SP20	SP21	SP19	SP21	SP21	SP20	SP20	SP20	SP21	SP21	SP21	SP20	
	2 1/2"	SP22	SP19	SP21	SP21	SP21	SP22	SP21	SP21	SP22	SP20	SP20	SP22	SP19	SP21	SP21	SP22	SP20	SP20	SP21	SP21	SP21	SP24	
63	2 1/2"	SP22	SP20	SP39	SP22	SP22	SP22	SP22	SP22	SP22	SP21	SP21	SP22	SP20	SP22	SP22	SP22	SP21	SP21	SP22	SP22	SP22	SP21	
	3"	SP25	SP20	-	SP22	SP25	SP22	SP22	SP25	SP22	SP21	SP25	SP20	SP22	SP22	SP22	SP25	SP21	SP21	SP25	SP22	SP22	SP26	
75S	2 1/2"	SP22	SP22	SP24	SP24	SP24	SP22	SP24	SP24	SP22	SP22	SP24	SP22	SP24	SP24	SP22	SP22	SP24	SP24	SP24	SP24	SP24	SP24	
	3"	SP25	SP22	SP24	SP24	SP24	SP25	SP24	SP24	SP25	SP22	SP22	SP25	SP22	SP24	SP24	SP25	SP22	SP22	SP24	SP24	SP24	SP24	
75	3"	SP25	SP23	SP25	SP25	SP25	SP25	SP25	SP25	SP23	SP23	SP25	SP23	SP25	SP25	SP25	SP23	SP23	SP25	SP25	SP25	SP26	SP24	
90	3"	SP26	SP26	-	SP25	SP25	SP35	SP27	SP27	SP35	SP35	SP35	SP27	SP25	SP27	SP27	SP35	SP35	SP35	SP27	SP27	SP27	SP26	
	4"	SP36	SP35	SP27	SP27	SP27	SP36	SP27	SP27	SP36	SP35	SP35	SP27	SP25	SP27	SP27	-	-	-	SP27	SP27	SP27	SP30	
100	4"	SP36	SP27	-	-	-	-	-	-	-	-	-	-	-	-	SP36	SP36	-	SP30	SP29	SP36	SP30	SP45	
115	4"	SP30	SP37	-	-	-	-	-	-	-	-	-	-	-	-	-	-	-	-	-	-	-	-	

For additional spanner sizes and additional Cable Gland types please contact CMP

Ingress Discs

CMP Ingress Discs are used as a means of maintaining the integrity of the enclosure prior to availability of the cable. They can be used to exclude dust and moisture from entering the enclosure, enabling the Cable Gland to be installed prior to the cable.

CMP Ingress Discs are available for all CMP Cable Glands used in Industrial and Ex e applications and are produced in high quality nickel plated brass with an Ingress Protection rating of IP66 when the sealing ring is engaged finger tight and one spanner turn, or as per the specific advice on CMP Installation Fitting Instructions.

CMP Products Ingress Discs are available for Industrial and Ex e applications only.

Ingress Discs can be ordered as a separate accessory using the below references or pre-installed in the cable gland by adding '1RD' to the ordering reference e.g. 20T3CDS1RD5 for a M20 nickel plated brass Triton CDS Cable Gland with Ingress Disc.



A2F

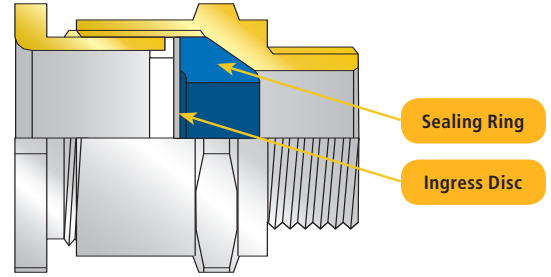

Cable Gland Size	Cable Gland Type		
	SS2K / PXSS2K	A**	E** / C** / PX** / T3CDS / TE1FU
20S16	ID015	ID015	ID025
20S	ID015	ID015	ID025
20	ID025	ID035	ID045
25S	-	-	ID065
25	ID045	ID055	ID065
32	ID065	ID075	ID085
40	ID085	ID085	ID105
50S	ID095	ID095	ID125
50	ID115	ID115	ID145
63S	ID135	ID135	ID165
63	ID145	ID155	ID185
75S	ID165	ID175	ID205
75	ID195	ID195	ID215
90	ID225	ID225	ID235
100	ID235	ID235	ID245
115	ID255	ID255	ID265
130	ID275	ID275	ID275

Shrouds

CMP Products' shrouds minimise the risk of dirt or foreign substances gathering on the Cable Gland and point of cable to cable gland interface.

LSF shrouds are Low Smoke & Fume (LSF), and Phosphorus Free to suit all CMP SOLO Cable Glands. Manufactured from low smoke, self-extinguishing, non-drip and halogen free material, these shrouds are rated UL94 V0 and are essential for areas where fire safety is key. CMP LSF shrouds and CMP SOLO Cable Glands meet the requirements of the London Underground Fire Safety Regulations and as such, they are LUL approved for use within the London Underground network.

CMP Shrouds are available in a variety of colours using the ordering references shown here, not all colours are available in all materials, please enquire for further information.

Temperature ratings for CMP shrouds are as follows:

- **PVC** -60°C to +90°C
- **LSF** -60°C to +130°C
- **PCP** -60°C to +100°C

Shroud sizes are referenced on each product page.



Shroud Colour	Shroud Material - Ordering Examples		
	LSF	PVC	PCP
Black	LSF06BLACK	PVC06	PCP06BLACK
Blue Grey	LSF06	PVC06GREY	-
Blue	-	PVC06BL	-
Red	-	PVC06RED	-
Orange	-	PVC06OR	-
Green	-	PVC06GRN	-
Yellow	-	PVC06YL	-



Grounding Locknuts

CMP Products' Grounding locknuts for use with cable glands, conduit fittings, tubing (EMT) fittings and conduit as a means of reliably and safely bonding the locknut (and gland) to the enclosure or equipment.

Providing electrical continuity and tested to the requirements of CEC and NEC wiring codes CMP's grounding locknuts reduce the chance of equipment failure, downtime, power interruptions and eliminate potential safety issues.

Grounding locknuts are available with either a grounding terminal or lay-in lug and are available in stainless steel (GRLN4), aluminum (GRLN1) and nickel plated brass (GRLN5), e.g 20GRLN4 for M20 Stainless Steel Grounding Locknut.

NPT grounding locknuts are supplied as standard in aluminum and Metric in nickel plated brass. Hammer and screwdriver installation grooves only on aluminium design (as pictured).

- Standard - Small Lay-in Lug - 14-4 AWG
- Optional - Medium Lay-in Lug - 14-2/0 AWG
- Optional - Large Lay-in Lug - 6-250 AWG

AWG - American wire gauge



Grounding Terminal

Straight Lay-in-Lug (Optional*)

Angled Lay-in-Lug (Standard*)

cCSAus Certificate	2450309
Code of Protection	Class I Zone 1 AExe II, Exe II
CLASS Categories	
C441404	Grounding and Bonding Devices
C441484	Grounding and Bonding Devices - Certified to US Standards
C909801	Miscellaneous - For Hazardous Locations
C909881	Miscellaneous - For Hazardous Locations - Certified to US Standards

NPT GROUNDING LOCKNUTS

Ordering Reference Aluminum with Angled Lay-in Lug			Thread Diameter NPT	Minimum Locknut Thickness 14-4 & 14-2/0 Lug	Minimum Locknut Thickness 6-250 Lug	Across Flats Dimension	Across Corners Diameter
Standard 14-4 AWG	Optional 14-2/0 AWG	Optional 6-250 AWG*					
050NPTGRLN14A	-	-	½"	0.48	-	1.20	1.32
075NPTGRLN14A	-	-	¾"	0.48	-	1.48	1.63
100NPTGRLN14A	100NPTGRLN110A	-	1"	0.48	-	1.81	1.99
125NPTGRLN14A	125NPTGRLN110A	-	1 ¼"	0.48	-	2.05	2.25
150NPTGRLN14A	150NPTGRLN110A	-	1 ½"	0.48	-	2.36	2.60
200NPTGRLN14A	200NPTGRLN110A	-	2"	0.48	-	2.76	3.03
250NPTGRLN14A	250NPTGRLN110A	250NPTGRLN125	2 ½"	0.48	0.68	3.54	3.90
300NPTGRLN14A	300NPTGRLN110A	300NPTGRLN125	3"	0.48	0.68	4.33	4.76
350NPTGRLN14A	350NPTGRLN110A	350NPTGRLN125	3 ½"	0.48	0.68	4.84	5.33
400NPTGRLN14A	400NPTGRLN110A	400NPTGRLN125	4"	0.48	0.68	5.24	5.76

Dimensions shown are in inches unless otherwise stated

Grounding Locknuts with Lay-in-Lug are available in Nickel Plated Brass & Stainless Steel.
Lay-in-Lug will always be Aluminum regardless of locknut material.
Lay-in-Lug may be angled or straight design, remove 'A' suffix from order reference for straight design.
*Only the straight lay-in-lug design is available for 6-250 AWG,

METRIC GROUNDING LOCKNUTS

Ordering Reference with Grounding Terminal		Thread Diameter Metric	Minimum Thickness	Across Flats Dimension	Across Corners Diameter
Standard Nickel Plated Brass	Optional Stainless Steel				
20GRLN5	20GRLN4	M20	0.48	1.20	1.32
25GRLN5	25GRLN4	M25	0.48	1.48	1.63
32GRLN5	32GRLN4	M32	0.48	1.81	1.99
40GRLN5	40GRLN4	M40	0.48	2.05	2.25
50GRLN5	50GRLN4	M50	0.48	2.36	2.60
63GRLN5	63GRLN4	M63	0.48	2.76	3.03
75GRLN5	75GRLN4	M75	0.48	3.54	3.90
90GRLN5	90GRLN4	M90	0.48	4.33	4.76
100GRLN5	100GRLN4	M100	0.48	4.84	5.33
115GRLN5	115GRLN4	M115	0.48	5.24	5.76

Dimensions shown are in inches unless otherwise stated

Grounding Terminal will always be Stainless Steel regardless of locknut material.
Grounding Terminal is suitable for wire sizes 0.5mm² to 2.5mm².





Selection & Specification

Selector charts for a range of standard armoured and unarmoured cables to a range of specifications for CMP Products Cable Glands and Cable Cleats.

Thread specifications and construction standards to ISO and ANSI standards including recommended clearance holes.

Material specifications for CMP's Cable Glands and Accessories.

If your cable is not listed here please contact CMP for further information and recommendations.





Material & Thread Specification

MATERIALS

Brass Extrusion*	BS EN 12164:2011 / BS EN 12168:2011	Grade: CuZn39Pb3 (CW614N)
Stainless Steel Extrusion	EN 10088-3 : 2014	Grade: 316S11, 316S13, 316S31, 316S33, 316, 316L
Aluminium Extrusion	BS EN 573-3:2013 / BS EN 755-1,-2,-3:2008	Grade: 6082 T6 OR 6262 T6
Aluminium Castings	BS EN 1706:2010 / BS EN 1676:2010	Grade: ENAC42000 / LM25 TF
Brass Castings*	BS 1400 : 1985	Grade: GB/T 5231-2012 HPb58-3 / ASTM 38000, JIS C3604

*Brass products may be nickel plated to a maximum thickness of 0.008mm
 Materials will contain less than: 7.5% magnesium, 7.5% titanium, 7.5% zirconium

THREAD CONSTRUCTION STANDARDS

Metric	ISO 965-1, ISO 965-3 medium fit (6g) for external threads, (6H) for internal threads
Imperial Conduit (ET)	BS 31:1940 (1979) Table 'A' external threads, Table 'B' internal threads
PG	DIN 40430:1971
BSPP	BS2279:1986 class A full form threads
BSPT	BS21:1985 standard threads only as clause 5.4, gauging to clause 5.2, system A
ISO	ISO 7/1:1994 gauging to ISO 7/2 clause 6.3 external threads, 6.2 internal threads
NPT	ANSI / ASME B1.20.1 - 2013 gauging to clause 3.2.1 for external threads, 3.2.2 for internal threads & IEC 60981
NPSM	ANSI / ASME B1.20.1 - 2013 gauging to clause 6.4

ISO METRIC IEC 60423

PG DIN 40430

THREAD REFERENCE	16	20	25	32	40	50	63	75	THREAD REFERENCE	PG7	PG9	PG11	PG13.5	PG16	PG21	PG29	PG36
THREAD SIZE	M16	M20	M25	M32	M40	M50	M63	M75	THREAD SIZE	PG7	PG9	PG11	PG13.5	PG16	PG21	PG29	PG36
THREAD PITCH	1.5	1.5	1.5	1.5	1.5	1.5	1.5	1.5	THREAD PITCH	1.27	1.41	1.41	1.41	1.41	1.59	1.59	1.59
THREAD PER INCH	16.93	16.93	16.93	16.93	16.93	16.93	16.93	16.93	THREAD PER INCH	20	18	18	18	18	16	16	16
MAJOR DIAMETER MAX	15.97	19.97	24.97	31.97	39.97	49.97	62.97	74.97	MAJOR DIAMETER MAX	12.5	15.2	18.6	20.4	22.5	28.3	37.0	47.0
RECOMMENDED CLEARANCE HOLE	16.5	20.5	25.5	32.5	40.5	50.5*	63.5*	75.5*	RECOMMENDED CLEARANCE HOLE	13.0	15.5	19.0	21.0	23.0	28.5	37.5	47.5

NPT ANSI B1.20.1

BSPP

THREAD REFERENCE	050	075	100	125	150	200	250	300	THREAD REFERENCE	050	075	100	125	150	200	250	300		
THREAD SIZE	½"	¾"	1"	1 ¼"	1 ½"	2"	2 ½"	3"	THREAD SIZE	½"	¾"	1"	1 ¼"	1 ½"	2"	2 ½"	3"		
THREAD PITCH	1.81	1.81	2.2	2.2	2.2	2.2	3.18	3.18	THREAD PITCH	1.81	1.81	2.31	2.31	2.31	2.31	2.31	2.31		
THREAD PER INCH	14	14	11.5	11.5	11.5	11.5	8	8	THREAD PER INCH	14	14	11	11	11	11	11	11		
MAJOR DIAMETER MAX	Metric	21.34	26.67	33.4	42.16	48.26	60.33	73.03	88.9	MAJOR DIAMETER MAX	Metric	20.96	26.44	33.25	41.91	47.8	59.61	75.18	87.88
	Imperial	0.84"	1.05"	1.32"	1.66"	1.90"	2.38"	2.88"	3.50"		Imperial	0.83"	1.04"	1.31"	1.65"	1.88"	2.35"	2.96"	3.46"
RECOMMENDED CLEARANCE HOLE	Metric	21.5	27.0	34.0	42.5	48.5	60.5*	73.5*	89.5*	RECOMMENDED CLEARANCE HOLE	Metric	21.5	27.0	33.5	42.5	48.0	60.0	75.5*	88.5*
	Imperial	5/64"	1-1/16"	1-21/64"	1-43/64"	1-29/32"	2-25/64**	2-57/64**	3-33/64**		Imperial	27/32"	1-1/16"	1-5/16"	1-43/64"	1-57/64"	2-23/64**	2-31/32"	3-31/64**
		0.86"	1.06"	1.33"	1.67"	1.91"	2.39**	2.89**	3.52**			0.84"	1.06"	1.31"	1.67"	1.89"	2.36**	2.97"	3.48**

NPSM ANSI B1.20.1

BSPT

THREAD REFERENCE	050	075	100	125	150	200	250	300	THREAD REFERENCE	050	075	100	125	150	200	250	300		
THREAD SIZE	½"	¾"	1"	1 ¼"	1 ½"	2"	2 ½"	3"	THREAD SIZE	½"	¾"	1"	1 ¼"	1 ½"	2"	2 ½"	3"		
THREAD PITCH	1.81	1.81	2.2	2.2	2.2	2.2	3.18	3.18	THREAD PITCH	1.81	1.81	2.31	2.31	2.31	2.31	2.31	2.31		
THREAD PER INCH	14	14	11.5	11.5	11.5	11.5	8	8	THREAD PER INCH	14	14	11	11	11	11	11	11		
MAJOR DIAMETER MAX	Metric	20.9	26.26	32.84	41.6	47.67	59.71	72.16	88.06	MAJOR DIAMETER MAX	Metric	20.96	26.44	33.25	41.91	47.8	59.61	75.18	87.88
	Imperial	0.82"	1.03"	1.29"	1.64"	1.88"	2.35"	2.84"	3.47"		Imperial	0.83"	1.04"	1.31"	1.65"	1.88"	2.35"	2.96"	3.46"
RECOMMENDED CLEARANCE HOLE	Metric	21.5	26.5	33.0	42.0	48.0	60.0	72.5*	88.5*	RECOMMENDED CLEARANCE HOLE	Metric	21.5	27.0	33.5	42.5	48.0	60.0	75.5*	88.5*
	Imperial	27/32"	1-3/64"	1-5/16"	1-21/32"	1-57/64"	2-3/8"	2-27/32"	3-31/64**		Imperial	27/32"	1-1/16"	1-5/16"	1-43/64"	1-57/64"	2-23/64**	2-31/32"	3-31/64**
		0.84"	1.05"	1.31"	1.66"	1.89"	2.38"	2.84"	3.48**			0.84"	1.06"	1.31"	1.67"	1.89"	2.36**	2.97"	3.48**

All dimensions in millimeters unless stated
 *Non-standard drill size



XLPE OR EPR/SWA/PVC CABLES TO BS5467 : 1997
 With Extruded Bedding & Circular / Shaped Stranded Copper Conductors 600 / 1000 Volts

XLPE / EPR

CABLE CONSTRUCTION				CMP CABLE GLAND SIZE			CMP CABLE CLEAT SIZE			
Conductor C.S.A. (mm ²)	Number of Cores	Nominal Diameters (mm)		Indoor	Outdoor		1 Bolt Metallic Closing	1 Bolt Polymer / Metallic	2 Bolt Polymer / Metallic	
		Under Armour	Overall		BW Cable Gland / Kit	C Type Cable Gland / Kit				E Type Cable Gland / Kit
1.5	2	8.1	12.5	20S	20S/16	20S/16	-	1013	-	
	3	8.6	13.0				-	-	-	
	4	9.4	14.0				-	-	-	
	7	11.3	15.9	25	20S	20S	-	1316	-	
	12	14.7	20.2				-	-	-	
	19	17.5	23.2				-	-	-	
	27	21.3	27.9				-	-	-	
37	23.8	30.6	32	32	32	-	2327	-		
						-	-	-		
						-	2732	-		
2.5	2	9.0	13.6	20S	20S	20S	-	1316	-	
	3	9.5	14.1				-		-	-
	4	10.4	15.0				-		-	-
	7	12.5	17.1	20	20	20	-	1619	-	
	12	16.7	22.4	25	25	25	-	1923	-	
	19	20.0	26.6	32	32	32	-	2327	-	
	27	23.9	30.7				-	-	-	
37	27.0	33.8	40	40	40	032038	3238	-		
4	2	10.1	14.7	20S	20S	20S	-	1316	-	
	3	10.7	15.3				-		-	-
	4	11.8	16.4				20		20	20
	7	14.2	19.7	25	25	25	-	1923	-	
	12	19.3	25.7	32	32	32	-	2327	-	
	19	22.7	29.3				-	-	-	
	27	27.4	34.4	40	40	40	032038	3238	-	
37	31.2	39.2	40				40	40	038046	3846
6	2	11.3	15.9	20S	20S	20S	-	1316	-	
	3	12.0	16.6	20	20	20	-	1619	-	
	4	13.2	18.7				-		-	-
10	2	13.2	18.0	20	20	20	-	1619	-	
	3	14.0	19.5	25	25	25	-	1923	-	
	4	15.6	21.1				-		-	-
16	2	14.5	20.0	25	25	25	-	1923	-	
	3	15.5	21.2				-		-	-
	4	17.2	22.9				-		-	-
25	2	18.4	24.1	25	25	25	-	2327	-	
	3	20.1	26.7	32	32	32	-	2732	-	
	4	22.3	28.9				-		-	-
35	2	21.3	27.9	32	32	32	-	2732	-	
	3	22.8	29.6				-		-	-
	4	25.3	32.1				032038		3238	-
50	2	19.0	25.8	25	25	25	-	2327	-	
	3	21.7	28.5	32	32	32	-	2732	-	
	4	25.0	32.0				032038		3238	-
70	2	22.0	29.0	32	32	32	-	2732	-	
	3	25.2	32.2				-		-	-
	4	29.5	37.7				40		40	40
95	2	27.3	35.5	40	40	40	032038	3238	-	
	3	31.1	39.3				-	-	-	
	4	35.9	44.3				50S	50S	50S	038046
120	2	27.9	36.1	40	40	40	032038	3238	-	
	3	32.0	40.4				038046	3846	-	
	4	37.5	47.1				50S	50S	50S	046051
150	2	30.9	39.3	40	40	40	038046	3846	038048	
	3	35.9	45.5	50S	50S	50S				
	4	41.6	51.4	50	50	50				
185	2	34.9	44.7	50S	50S	50S	038046	3846	038048	
	3	40.0	49.8	50	50	50	046051	4651	048058	
	4	46.4	56.6	63S	63S	63S	051058	515758		
240	2	39.0	49.0	50	50	50	046051	4651	048058	
	3	44.9	55.1	63S	63S	63S	051058	515758		
	4	52.6	63.0	63	63	63	058070	5865	058070	
300	2	43.3	53.5	50	50	50	051058	515758	048058	
	3	49.8	60.2	63S	63S	63S	058070	5865	058070	
	4	58.0	68.8	75S	75S	75S		6571		
400	2	48.4	59.0	63S	63S	63S	058070	5865	058070	
	3	58.8	66.6	63	63	63		6571		
	4	65.4	78.1	75	75	75		070083		-

For cables up to 35mm sq, conductors are circular stranded and for cables 50mm sq and over conductors are shaped stranded
 Ordering Prefix: Sapphire - SHDSS, Sabre - 1BC, Valiant - 1BC**A, Falcon - 2BC, Zenith - 2BC**A
 Red text is metallic cable cleats only

CMP PRODUCTS CABLE GLAND SELECTION



PVC/SWA/PVC CABLES TO BS5467 : 1997
 With Extruded Bedding & Circular / Shaped Stranded Copper Conductors 600 / 1000 Volts

PVC

CABLE CONSTRUCTION				CMP CABLE GLAND SIZE			CMP CABLE CLEAT SIZE						
Conductor C.S.A. (mm ²)	Number of Cores	Nominal Diameters (mm)		Indoor BW Cable Gland / Kit	Outdoor		1 Bolt Metallic Closing & Hinged Sapphire Cable Cleat	1 Bolt Polymer / Metallic Sabre / Valiant Cable Cleat	2 Bolt Polymer / Metallic Falcon / Zenith Cable Cleat				
		Under Armour	Overall		C Type Cable Gland / Kit	E Type Cable Gland / Kit							
1.5	2	7.7	12.3	20S	20S/16	20S/16	-	1013	-				
	3	8.2	12.8				-		-				
	4	8.9	13.5		20S	20S	-		1316	-			
	7	10.6	15.2				-			-			
	12	13.9	19.4	20	20	20	-	1923	-				
	19	16.5	22.2	25	25	25	-		-				
	27	20.1	26.7	32	32	32	-	2327	-				
	37	22.4	29.2				-		-	2732	-		
48	25.9	32.9	-				-		032038	3238	-		
-	-	-	-				-		-	-	-	-	
2.5	2	9.0	13.6	20S	20S	20S	-	1316	-				
	3	9.5	14.1				-		-				
	4	10.4	15.0		20	20	20		-	1619	-		
	7	12.5	18.0						-		-		
	12	16.7	22.4	25	25	25	-	1923	-				
	19	20.0	26.6	32	32	32	-		2327	-			
	27	23.9	30.7				-	-		2732	-		
	37	27.0	34.0				40	40		40	032038	3238	-
48	31.3	39.5	038046								3846	038048	
4	2	10.5	15.1	20S	20S	20S	-	1316	-				
	3	11.2	15.8				-		-				
	4	12.3	17.8		20	20	20		-	1619	-		
	7	14.8	20.5		25	25	25		-		1923	-	
	12	20.2	26.8	32	32	32	-	2327	-				
	19	23.7	30.5				-		-	2732	-		
	27	29.1	37.1				40		40	40	032038	3238	-
	37	32.6	40.8				50S		50S	50S	038046	3846	038048
48	37.6	46.0	046051	4651									
6	2	11.7	16.5	20	20	20	-	1619	-				
	3	12.5	18.0				-		-				
	4	13.7	19.2				-		-	1923	-		
10	2	14.4	20.1	25	25	25	-	1923	-				
	3	15.5	21.2				-		-				
	4	17.1	22.8				-		-	-	-		
16	2	16.2	21.9	25	25	25	-	1923	-				
	3	17.4	23.1		32	32	-		2327	-			
	4	19.7	26.3				-			-			
25	2	20.1	26.7	32	32	32	-	2327	-				
	3	21.6	28.2				-		-	2732	-		
	4	23.9	30.7				-		-	-	-		
35	2	22.4	29.2	32	32	32	-	2327	-				
	3	24.0	30.8				-		-	2732	-		
	4	26.7	33.7				40		40	40	032038	3238	-
50	2	20.8	27.8	32	32	32	-	2732	-				
	3	23.5	30.5				-		-	032038	3238	-	
	4	27.4	35.4				40		40	40	032038	3238	-
70	2	23.4	30.4	32	32	32	-	2732	-				
	3	27.0	35.0				40		40	40	032038	3238	-
	4	31.0	39.2								038046	3846	038048
95	2	27.3	35.5	40	40	40	032038	3238	-				
	3	31.1	39.3				50S	50S	50S	038046	3846	038048	
	4	35.9	44.3							-	-	-	-
120	2	29.6	38.0	40	40	40	038046	3846	038048				
	3	33.8	42.2		50S	50S				-	-	-	
	4	39.5	49.3							50S	50	50	046051
150	2	32.7	41.3	50S	50S	50S	038046	3846	038048				
	3	37.7	47.5		50	50				-	-	-	
	4	43.6	53.6							50	63S	63S	051058
185	2	36.6	46.4	50S	50S	50S	046051	4651	038048				
	3	41.9	51.9		50	50				051058	515758	048058	
	4	48.8	59.0							63S	63S	63S	058070
240	2	41.2	51.2	50	50	50	051058	515758	048058				
	3	47.6	57.8		63S	63S				63S	-	-	-
	4	55.1	65.7								63	63	63
300	2	46.0	56.4	63S	63S	63S	051058	515758	048058				
	3	52.6	63.2		63	63				63	058070	5865	-
	4	61.0	72.0								75S	75S	75S
400	2	51.1	61.9	63	63	63	058070	5865	058070				
	3	58.6	69.6		75S	75S				75S	058070	6571	-
	4	68.4	81.3								-	90	90

For cables up to 35mm sq, conductors are circular stranded and for cables 50mm sq and over conductors are shaped stranded

Ordering Prefix: Sapphire - SHDSS, Sabre - 1BC, Valiant - 1BC**A, Falcon - 2BC, Zenith - 2BC**A

Red text is metallic cable cleats only



XLPE OR EPR / SWA / PVC CABLES TO BS5467 : 1997
 With Extruded Bedding and Circular / Shaped Stranded Copper Conductors 600 / 1000 Volts

XLPE / EPR

CABLE CONSTRUCTION				CMP CABLE GLAND SIZE			CMP CABLE CLEAT SIZE				
Conductor C.S.A. (mm ²)	Number of Cores	Nominal Diameters (mm)		Indoor	Outdoor		1 Bolt Metallic Closing & Hinged Sapphire Cable Cleat	1 Bolt Polymer / Metallic Sabre / Valiant Cable Cleat	2 Bolt Polymer / Metallic Falcon / Zenith Cable Cleat		
		Under Armour	Overall		BW Cable Gland / Kit	C Type Cable Gland / Kit				E Type Cable Gland / Kit	
1.5	2	7.7	12.1	205	20516	20516	-	1013	-		
	3	8.2	12.6				-		-		
	4	8.9	13.3				-		-		
	5	9.7	14.3	25	205	205	-	1316	-		
	7	10.6	15.2				-		-		
	12	13.9	19.4				-		-		
	19	16.5	22.2	32	20	20	-	1923	-		
	27	20.1	26.7				-		-		
	37	22.4	29.0				-		-		
48	25.9	32.7	205	205	205	-	1316	-			
2	9.0	13.6				-		-			
3	9.5	14.1				-		-			
4	10.4	15.0				-		-			
5	11.5	16.1				-		-			
7	12.5	17.1				20		20	-	1619	-
12	16.7	22.4				25		25	-	1923	-
19	20.0	26.6				32		32	-	2327	-
27	23.9	30.7				40		40	-	2732	-
37	27.0	33.8	205	205	205	-	3238	-			
48	31.3	39.3				-		-			
2	10.1	14.7				-		-			
3	10.7	15.3	20	20	-	1316	-				
4	11.8	16.4	25	20	20	-	1623	-			
5	13.0	17.8				-		-			
7	14.2	19.7				-		-			
12	19.3	25.7	32	32	32	-	2327	-			
19	22.7	29.3	40	40	40	-	2732	-			
27	27.4	34.4	505	505	505	032038	3238	-			
37	31.2	39.2	205	205	205	-	3846	-			
48	35.9	44.1				-		-			
2	11.3	15.9				-		-			
3	12.0	16.6	20	20	20	-	1316	-			
4	13.2	18.7	25	25	25	-	1623	-			
5	14.5	20.0				-		-			
2	13.2	18.0				20		20	20	-	-
3	14.0	19.5	25	25	25	-	1623	-			
4	15.6	21.1				-		-			
5	17.2	22.9				-		-			
2	14.9	20.4	25	25	25	-	1623	-			
3	15.9	21.6				-		-			
4	17.7	23.4				-		-			
5	20.0	26.6	32	32	32	-	2327	-			
2	18.4	24.1	25	25	25	-	-	-			
3	20.1	26.7	32	32	32	-	2327	-			
4	22.3	28.9				-		-			
5	24.7	31.5				-		-			
2	21.1	27.7	32	32	32	-	2732	-			
3	22.6	29.4				-		-			
4	25.1	31.9				-		-			
5	27.8	34.8	40	40	40	-	3238	-			
2	19.0	25.8	25	25	25	-	2327	-			
3	21.7	28.5	32	32	32	-	2732	-			
4	25.0	32.0				-		-			
5	32.4	40.4				505		505	505	038046	3846
2	22.0	29.0	32	32	32	-	2732	-			
3	25.2	32.2				-		-			
4	29.5	37.7				40		40	40	032038	3238
5	37.9	46.3	505	505	505	-	-	-			
2	25.1	33.1	32	32	32	046051	4651	038048			
3	28.8	37.0	40	40	40	-	-	-			
4	33.3	41.7	505	505	505	038046	3846	038048			
2	27.9	36.1	40	40	40	032038	3238	-			
3	32.0	40.4				-	-				
4	37.5	47.1				505	505	505	038046	3846	038048
2	30.9	39.3	40	40	40	-	-	-			
3	35.9	45.5	505	505	505	038046	3846	038048			
4	41.6	51.4	50	50	50	051058	515758	048058			
2	34.9	44.7	505	505	505	038046	3846	038048			
3	40.0	49.8	50	50	50	046051	4651	-			
4	46.4	56.6	63	63	63	051058	515758	048058			
2	39.0	49.0	50	50	50	046051	4651	-			
3	44.9	55.1	635	635	635	051058	515758	048058			
4	52.6	63.0	63	63	63	058070	5865	058070			
2	43.3	53.5	50	50	50	051058	515758	048058			
3	49.8	60.2	635	635	635	-	-	-			
4	58.0	68.8	755	755	755	058070	5865	058070			
2	48.4	59.0	635	635	635	-	-	-			
3	58.8	66.6	63	63	63	058070	5865	058070			
4	65.4	78.1	75	75	75	070083	-	070083			

CMP PRODUCTS CABLE GLAND SELECTION



GSWB OR BWB BRAID ARMOUR CABLE TO BS6883:1999
Multipair Instrumentation Cable 150 / 250 VOLT

XLPE

CABLE CONSTRUCTION				CMP CABLE GLAND SIZE			CMP CABLE CLEAT SIZE			
Conductor C.S.A. (mm²)	Number of Cores	Configuration	Nominal Diameters (mm)		Outdoor			1 Bolt Metallic Closing & Hinged	1 Bolt Polymer / Metallic	2 Bolt Polymer / Metallic
			Under Armour	Overall	C Type Cable Gland / Kit	E Type / Triton Cable Gland	PX Type Cable Gland	Sapphire Cable Cleat	Sabre / Valiant Cable Cleat	Falcon / Zenith Cable Cleat
0.75	1 Pr	Individually Screened Pairs	7.5	11.5	20S/16	20S/16	20S/16	-	1013	-
	3 Pr		14.2	18.6	25	25	25	-	1923	-
	7 Pr		19.0	24.0				-	2327	-
	12 Pr		25.5	30.7	32	32	32	-	2732	-
	20 Pr		32.5	39.1	50S	50S	50S	038046	3846	038048
	27 Pr		36.9	44.1				046051	4651	048058
37 Pr	41.8	49.2	50	50	50	046051	4651	048058		
0.75	3 Pr	Collectively Screened Pairs	12.9	17.3	20	20	20	-	1319	-
	7 Pr		17.0	21.7	25	25	25	-	1923	-
	12 Pr		22.6	27.6	32	32	32	-	2732	-
	20 Pr		28.2	34.7	40	40	40	-	3238	-
	27 Pr		32.0	38.8				038046	3846	038048
	37 Pr		36.1	43.3	50S	50S	50S	038046	3846	038048
1.0	1 Pr	Individually Screened Pairs	7.9	11.9	20S/16	20S/16	20S/16	-	1013	-
	3 Pr		15.2	19.7	25	25	25	-	1923	-
	7 Pr		20.2	25.1	32	32	32	-	2327	-
	12 Pr		27.5	33.8	40	40	40	-	3238	-
	20 Pr		34.7	41.6	50S	50S	50S	038046	3846	038048
	27 Pr		39.4	46.7	50	50	50	046051	4651	038048
	37 Pr		44.8	52.6	63S	63S	63S	051058	515758	048058
1.0	3 Pr	Collectively Screened Pairs	13.6	18.0	20	20	20	-	1319	-
	7 Pr		18.0	23.0	25	25	25	-	2327	-
	12 Pr		24.0	29.2	32	32	32	-	2732	-
	20 Pr		29.9	36.7	40	40	40	-	3238	-
	27 Pr		34.3	41.2	50S	50S	50S	038046	3846	038048
	37 Pr		38.6	46.0	50	50	50	046051	4651	038048
0.75	1 Pr	Individually Screened Pairs	8.1	12.2	20S/16	20S/16	20S/16	-	1013	-
	3 Pr		15.9	21.0	25	25	25	-	1923	-
	7 Pr		21.4	26.4	32	32	32	-	2327	-
	12 Pr		28.6	35.1	40	40	40	-	3238	-
0.75	3 Pr	Collectively Screened Pairs	14.4	18.8	25	25	25	-	1319	-
	7 Pr		18.8	23.8	32	32	32	-	2327	-
	12 Pr		25.3	30.9	40	40	40	-	3238	-
1.0	1 Pr	Individually Screened Pairs	8.8	12.8	20S	20S	20S	-	1013	-
	3 Pr		16.9	21.7	25	25	25	-	1923	-
	7 Pr		22.8	27.8	32	32	32	-	2732	-
	12 Pr		30.9	37.3	40	40	40	-	3238	-
1.0	3 Pr	Collectively Screened Pairs	15.2	19.8	25	25	25	-	1923	-
	7 Pr		20.2	25.3	32	32	32	-	2327	-
	12 Pr		26.9	33.6	40	40	40	-	3238	-
0.75	1 Qds	Individually Screened Pairs	9.4	13.4	20S	20S	20S	-	1316	-
	3 Qds		18.2	23.0	25	25	25	-	2327	-
	7 Qds		25.0	29.8	32	32	32	-	2732	-
1.0	1 Qds	Collectively Screened Pairs	9.9	13.9	20S	20S	20S	-	1316	-
	3 Qds		19.6	24.6	25	25	25	-	2327	-
	7 Qds		26.7	31.9	40	40	40	-	2732	-

For cables up to 35mm sq, conductors are circular stranded and for cables 50mm sq and over conductors are shaped stranded
 Ordering Prefix: Sapphire - SHDSS, Sabre - 1BC, Valiant - 1BC**A, Falcon - 2BC, Zenith - 2BC**A

Red text is metallic cable cleats only



UNARMoured XLPE/PVC CABLE TO BS6883:1999
 Multipair Instrumentation Cable 150 / 250 VOLT

XLPE

CABLE CONSTRUCTION				CMP CABLE GLAND SIZE			CMP CABLE CLEAT SIZE		
Conductor C.S.A. (mm²)	Number of Cores	Configuration	Overall Nominal Diameters (mm)	Outdoor			1 Bolt Metallic Closing & Hinged	1 Bolt Polymer / Metallic	2 Bolt Polymer / Metallic
				A Type Cable Gland / Kit	SS2K Cable Gland	PXSS2K Cable Gland	Sapphire Cable Cleat	Sabre / Valiant Cable Cleat	Falcon / Zenith Cable Cleat
0.75	1 Pr	Individually Screened Pairs	7.5	20S/16	20S/16	20S/16	-	-	-
	3 Pr		14.2	25	25	25	-	1319	-
	7 Pr		19.0	32	32	32	-	1927	-
	12 Pr		25.5	50S	50S	50S	032038	3238	-
	20 Pr		32.5	50	50	50	038046	3846	038048
	27 Pr		36.9						
	37 Pr		41.8						
0.75	3 Pr	Collectively Screened Pairs	12.9	20	20	20	-	1013	-
	7 Pr		17.0	25	25	25	-	1319	-
	12 Pr		22.6	32	32	32	-	1927	-
	20 Pr		28.2	40	40	40	-	2732	-
	27 Pr		32.0	50S	50S	50S	032038	3238	-
	37 Pr		36.1						
1.0	1 Pr	Individually Screened Pairs	7.9	20S/16	20S/16	20S/16	-	-	-
	3 Pr		15.2	25	25	25	-	1319	-
	7 Pr		20.2	32	32	32	-	2327	-
	12 Pr		27.5	40	40	40	-	2732	-
	20 Pr		34.7	50S	50S	50S	032038	3238	-
	27 Pr		39.4	50	50	50	038046	3846	038048
	37 Pr		44.8	63S	63S	63S			
1.0	3 Pr	Collectively Screened Pairs	13.6	20	20	20	-	1319	-
	7 Pr		18.0	25	25	25	-	2327	-
	12 Pr		24.0	32	32	32	-	2732	-
	20 Pr		29.9	40	40	40	032038	3238	-
	27 Pr		34.3	50S	50S	50S	038046	3846	038048
	37 Pr		38.6	50	50	50			
0.75	1 Pr	Individually Screened Pairs	8.1	20S/16	20S/16	20S/16	-	-	-
	3 Pr		15.9	25	25	25	-	1319	-
	7 Pr		21.4	32	32	32	-	1923	-
	12 Pr		28.6	40	40	40	-	2732	-
0.75	3 Pr	Collectively Screened Pairs	14.4	25	25	25	-	1319	-
	7 Pr		18.8	32	32	32	-	2327	-
	12 Pr		25.3	40	40	40	-	2732	-
1.0	1 Pr	Individually Screened Pairs	8.8	20S	20S	20S	-	-	-
	3 Pr		16.9	25	25	25	-	1319	-
	7 Pr		22.8	32	32	32	-	1923	-
	12 P		30.9	40	40	40	-	2732	-
1.0	3 Pr	Collectively Screened Pairs	15.2	25	25	25	-	1319	-
	7 Pr		20.2	32	32	32	-	1923	-
	12 Pr		26.9	40	40	40	-	2327	-
0.75	1 Qds	Individually Screened Pairs	9.4	20S	20S	20S	-	-	-
	3 Qds		18.2	25	25	25	-	1319	-
	7 Qds		25.0	32	32	32	-	2327	-
1.0	1 Qds	Collectively Screened Pairs	9.9	20S	20S	20S	-	-	-
	3 Qds		19.6	25	25	25	-	1923	-
	7 Qds		26.7	40	40	40	-	2327	-

For cables up to 35mm sq, conductors are circular stranded and for cables 50mm sq and over conductors are shaped stranded

Ordering Prefix: Sapphire - SHDSS, Sabre - 1BC, Valiant - 1BC**A, Falcon - 2BC, Zenith - 2BC**A

Red text is metallic cable cleats only



NEWCASTLE (Headquarters)

Tel: +44 (0) 191 2657411
Fax: +44 (0) 1670 715 646
E-Mail: customerservices@cmp-products.com
CMP Products Limited
36, Nelson Way, Nelson Park East
Cramlington, Northumberland
NE23 1WH, United Kingdom



HOUSTON (Texas Inc)

Tel: +1 281 776 5201
Fax: +1 281 776 5223
E-Mail: houstonoffice@cmp-products.com
CMP Products Texas Inc
5222 N. Sam Houston Pkwy E.
Houston, Texas, 77032, USA



PERTH, WA

Tel: +61 8 9249 4508
Fax: +61 8 9249 4608
E-Mail: perthoffice@cmp-products.com
CMP Products Pty Ltd
Unit 3-22 Harlond Avenue, Malaga, WA 6090
Australia

BRISBANE, QLD

Tel: +61 7 3801 0301
Fax: +61 7 3801 0300
E-Mail: qldoffice@cmp-products.com
CMP Products Pty Ltd
Unit 2 / 1-5 Knobel Court, Shailer Park, QLD 4128
Australia



DUBAI

Tel: +971 4 214 6114
Fax: +971 4 214 6117
E-Mail: meoffice@cmp-products.com
CMP Products Middle East Office
Office 6WA Room 134, PO BOX 371725
Dubai Airport Free Zone, Dubai,
United Arab Emirates



BUSAN

Tel: +82 51 780 5300
Fax: +82 51 780 8348
E-Mail: busanoffice@cmp-products.com
CMP Products (Korea) Ltd
19F Rm1915 Centum IS Tower, #1209,
Jaesong1-dong, Haeundae-gu, Busan,
South Korea, 612059



SINGAPORE

Tel: +65 6466 6180
Fax: +65 6466 9891
E-Mail: seaoffice@cmp-products.com
CMP Products (S.E.A) Pte Ltd.
21 Toh Guan Road East, #09-03,
Toh Guan Centre, Singapore 608609



SHANGHAI

Tel: +86 21 6093 2633
Fax: +86 21 6093 2630
E-Mail: shanghaioffice@cmp-products.com
CMP Products Division
Room 304, Building 7, No.1888 Xinqiao Road
Pudong, Shanghai 201206, P.R. China



JOHANNESBURG

Tel: +27 11 266 8880
Fax: +27 86 554 3240
E-Mail: africaoffice@cmp-products.com
CMP Products
49 New Road, Block A, Ground Floor
Midrand,1685, Johannesburg, S.A



MOSCOW

Tel: +7 495 803 3794
E-Mail: russiaoffice@cmp-products.com
CMP Products
115280, Russia, Moscow,
Leninskaya Sloboda Str, House Number 26,
Structure 28, Office 133

