

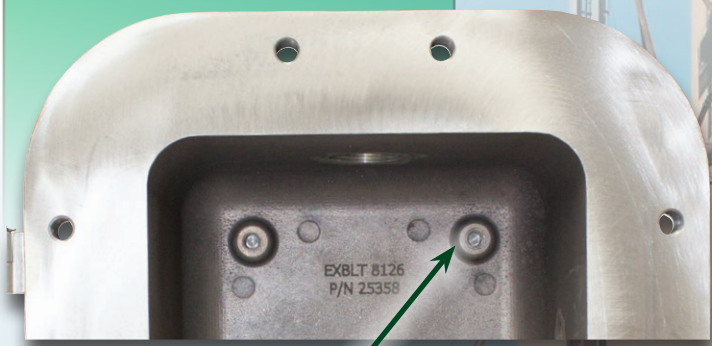

EXBLT SERIES

EXBLT Series is up to 35% lighter than EXB Series



Predrilled internal mounting pan bosses as standard. Uses same mounting pans as the EXB series

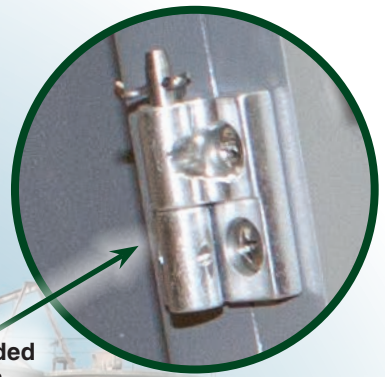

Hinges are extruded aluminum with stainless steel pin and hardware

Mounting lugs can be rotated 90°

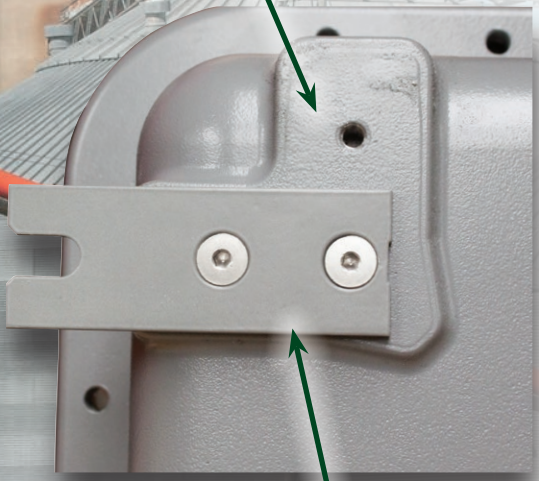

Ductile mounting lugs. Lugs are made of a ductile aluminum alloy to adjust to irregular mounting surfaces without damaging the enclosure. Easily replaced if damaged.



Nitrile (BUNA-N) "O" ring gasket is located inside the bolt circle for wet locations, Type 4 & IP66

Fewer cover bolts required – faster in and out

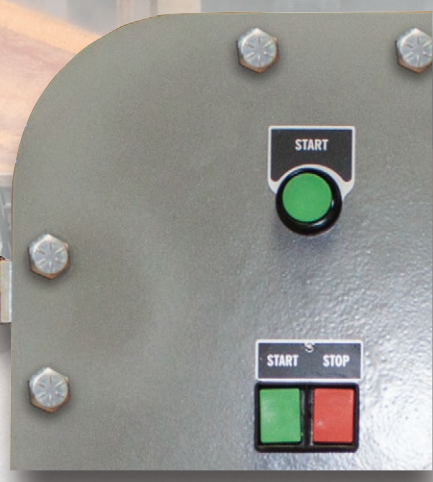



JUNCTION BOXES

EXBLITE



EXBLT

Empty / Control Enclosure

NEC / CEC Certifications

Class I, Groups B, C & D

Class I, Zone 1, IIB+H2

Class II, Groups E, F & G

Class III

Type 3, 4, 4X

Ta = -25°C to +60°C (UL)

Ta = -50°C to +60°C (CSA)

Files E83969

File LR11716 - 1723354



ATEX Certificate

II 2 G D CE 2813

Ex d IIB+H2 Gb 6 or T5

Ex tb IIIC Db IP66 T85°C or T100°C

Ta = -50°C to +70°C

QPS 21 ATEX 0001U

QPS 21 ATEX 0002X



IEC Ex Certificate

Ex db IIB+H2 Gb T6 or T5

Ex tb IIIC Db IP66 T85°C or T100°C

Ta = -50°C to +70°C

IECEX QPS 17.0013U

IECEX QPS 17.0014X

FEATURES-SPECIFICATIONS

EXBLT- For North America and for Global Applications by Adding Suffix "CEN".

Features

- The EXBLTP series is up to 35% lighter than the EXB Series enclosures.
- Copper-free cast/plate aluminum construction. High strength, lighter in weight, highly corrosion resistant.
- Choice of two covers:
 - » Flat aluminum plate cover (EXBLTP)
 - » Original aluminum sand cast cover (EXBLTC)
- Fewer cover bolts – reduces installation and maintenance time. Offered in plated carbon steel, 316SS and 316SS Tri-Lead for quicker access.
- Gasketed cover flange as standard. Nitrile (BUNA-N) "O" ring gasket is located inside the bolt circle to prevent water from seeping into the enclosure
- Mounting lugs are made of ductile aluminum alloy to adjust to irregular mounting surfaces without damaging the enclosure. EXBLTs 8x12x6x and larger supplied with bi-directional mounting pads. Lugs can installed either horizontal or vertical by the factory or in the field. Easily replaced if damage does occur.

- Hinges supplied as standard on the 6x12x4, 6x12x6 8x12x6 and larger. Smaller sizes can be ordered with hinges by adding SU2 to the catalog number. Hinges can be mounted on any of the 4 sides
- Enclosures can be drilled and tapped with conduit openings up to 2" NPT or M63 openings in factory or field.
- Covers both plate and cast can be drilled and tapped for G Series control operators openings and EXH disconnect handles, factory or field. The original aluminum sand cast cover, EXBLTC, can be provided with the GLXR rectangular viewing windows and the GL round threaded viewing windows.
- Cover flanges supplied with recessed notches for prying the covers open without damaging the ground flame path
- The mounting pan bosses are pre-drilled for the factory or field installation of the optional back pans

Material/Finish

- **BOX:** Molded from 356-T6 copper free aluminum, less than 4/10 of 1% copper alloy and less than 6% magnesium
- **COVER:** EXBLTP plate cover is made of 6061-T6 aluminum alloy
- **COVER:** EXBLTC cast from 310 copper free aluminum, less than 4/10 of 1% copper alloy and less than 6% magnesium
- **BOLTS:** Plated carbon steel
- **HINGES:** Extruded aluminum with stainless steel pin and hardware
- **OPTIONAL:** Mounting pans sheet aluminum 6061-T6 or 5052-H34
- **OPTIONAL:** Viewing windows tempered soda lime glass
- **FINISH:** Plate cover supplied with natural finish. Box and cast cover are painted with wet lacquer
- Conduits must be sealed within 18" for Class I Group B applications
- All conduits or gland openings must be sealed adjacent to the wall for Ex d applications
- For Type 4X rating, add N4X or N4XTL

Offered With the New GZ Series Operators



EXBLT SERIES

CATALOG LOGIC AND MODIFICATIONS

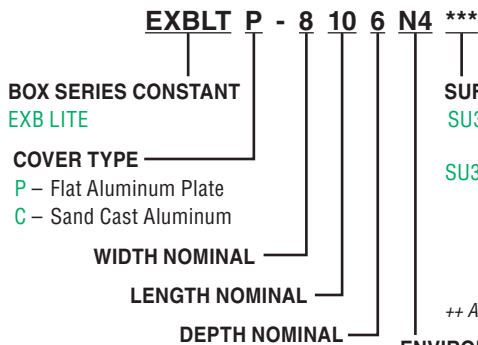

SUFFIXES ++
SU3-B-4X – Type 4X drain & breather installed Groups BCD
SU3-ATEX – ATEX IEC Ex drain & breather installed Groups B & Ex d+IIB
SU2 – Install hinges - EXBLT-8106 and smaller
SU9 – Special paint
SU93 – Do not paint
 ++ Additional suffixes are available

ENVIROMENTAL RATING
N4 – Type 4 Steel external hardware
N4X – Type 4X Stainless steel external hardware
N4TL – Type 4X Tri-lead stainless steel external hardware
N4CEN – Type 4X, IP66 ATEX & IEC Ex Certifications

MODIFICATIONS	
SUFFIX NUMBER	DESCRIPTION
N4CEN	ATEX & IEC Ex Certifications, IP66 Type 4X
N4X	Stainless steel external hardware for Type 4X
N4TL	Tri-lead stainless steel external hardware for Type 4X
KIT-251	100 amp ground lug
KIT-252	200 amp ground lug
SU3B-QA	cCSAus, ATEX, IEC Ex drain & breather installed Class I Groups B & Ex d IIB+H2, Type 4, 4X, IP66
SU3B-4X	Drain & breather installed Class I Groups B, Type 4, 4X
SU2	Install hinges - EXB-8106 and smaller.
SU14	Fungus Proof Internal
SU9	Special paint
SU93	Do not paint

EXBLT - Global Application, IEC Ex & ATEX
 Add Suffix "N4CEN" to the catalog logic.

CATALOG NUMBER	NOMINAL ENCLOSURE INSIDE DIMENSIONS W" L" D" (MM)	MAXIMUM SIZES - NPT / METRIC	OPTIONAL MOUNTING PAN NUMBER	MAXIMUM NUMBER OF OPERATORS	EXBLTP WEIGHT LBS (KGS)	EXBLTC WEIGHT LBS (KGS)	EXBLTP HINGES	EXBLTC HINGES
EXBLT*-664 N4	6x6x4 (152x152x102)	2" / M63	7997-5	2 rows of 2 = 4	18.2 (8.3)	20.4 (9.3)	HINGE-12L	HINGE-12L
EXBLT*-684 N4	6x8x4 (152x203x102)	2" / M63	7997-1	2 rows of 3 = 6	21.1 (9.6)	22.7 (10.3)	HINGE-12L	HINGE-12L
EXBLT*-686 N4	6x8x6 (152x203x152)	2" / M63	7997-1	2 rows of 3 = 6	23.7 (10.8)	25.3 (11.5)	HINGE-12L	HINGE-12L
EXBLT*-6124 N4	6x12x4 (152x305x102)	2" / M63	7997-6	4 rows of 2 = 8	29.2 (13.2)	39.2 (17.8)	HINGE-12L	HINGE-12L
EXBLT*-6126 N4	6x12x6 (152x305x152)	2" / M63	7997-6	4 rows of 2 = 8	32.6 (14.8)	42.6 (19.3)	HINGE-12L	HINGE-12L
EXBLT*-886 N4	8x8x6 (203x203x152)	2" / M63	7996-1	3 rows of 3 = 9	27.9 (12.7)	32.6 (17.8)	HINGE-12L	HINGE-12L
EXBLT*-8104 N4	8x10x4 (203x254x102)	2" / M63	7996-2	4 rows of 3 = 12	28.6 (13)	35.5 (16.1)	HINGE-12L	HINGE-12L
EXBLT*-8106 N4	8x10x6 (203x254x152)	2" / M63	7996-2	4 rows of 3 = 12	31.9 (14.5)	38.8 (17.6)	HINGE-12L	HINGE-12L
EXBLT*-8126 N4	8x12x6 (203x305x152)	2" / M63	17619	4 rows of 3 = 12	46.9 (21.3)	58.3 (26.4)	HINGE-12L	HINGE-11L
EXBLT*-8128 N4	8x12x8 (203x305x203)	2" / M63	17619	4 rows of 3 = 12	51.6 (23.4)	63 (28.6)	HINGE-12L	HINGE-11L
EXBLT*-9116 N4	9x11x6 (229x280x152)	2" / M63	25803	4 rows of 3 = 12	36.2 (16.4)	42.5 (19.3)	HINGE-12L	HINGE-12L
EXBLT*-10106 N4	10x10x6 (254x254x152)	2" / M63	17618	4 rows of 3 = 12	48.8 (22.1)	64.5 (29.3)	HINGE-12L	HINGE-11L
EXBLT*-10108 N4	10x10x8 (254x254x203)	2" / M63	17618	4 rows of 3 = 12	53.5 (24.3)	69.2 (31.4)	HINGE-12L	HINGE-11L
EXBLT*-10146 N4	10x14x6 (254x356x152)	2" / M63	17617	5 rows of 3 = 15	59.7 (27.07)	77.9 (35.3)	HINGE-12L	HINGE-11L
EXBLT*-10148 N4	10x14x8 (254x356x203)	2" / M63	17617	5 rows of 3 = 15	65.3 (29.6)	83.5 (37.9)	HINGE-12L	HINGE-11L
EXBLT*-12126 N4	12x12x6 (305x305x152)	2" / M63	7988-1	4 rows of 4 = 16	55 (25)	71.8 (32.6)	HINGE-12L	HINGE-11L
EXBLT*-12128 N4	12x12x8 (305x305x203)	2" / M63	7988-1	4 rows of 4 = 16	60.3 (27.4)	77.1 (35)	HINGE-12L	HINGE-11L
EXBLT*-12186 N4	12x18x6 (305x457x152)	2" / M63	15515	7 rows of 4 = 28	82 (37.2)	93 (42.2)	HINGE-11L	HINGE-11L
EXBLT*-12188 N4	12x18x8 (305x457x203)	2" / M63	15515	7 rows of 4 = 28	89 (40.7)	100 (45.4)	HINGE-11L	HINGE-11L
EXBLT*-12246 N4	12x24x6 (305x610x152)	4" / M100	15516	9 rows of 4 = 36	110 (50)	133 (60.3)	HINGE-11L	HINGE-11L
EXBLT*-12248 N4	12x24x8 (305x610x203)	4" / M100	15516	9 rows of 4 = 36	122 (55.4)	145 (65.8)	HINGE-11L	HINGE-11L
EXBLT*-14148 N4	14x14x8 (356x356x203)	2" / M63	17621	5 rows of 5 = 25	88 (40)	108 (49)	HINGE-11L	HINGE-11L
EXBLT*-14248 N4	14x24x8 (406x610x203)	4" / M100	51705	9 rows of 5 = 45	142 (64.4)	N/A	HINGE-11L	HINGE-11L
EXBLT*-14308 N4	14x30x8 (406x762x203)	4" / M100	51698	11 rows of 5 = 55	166 (75.3)	N/A	HINGE-11L	HINGE-11L
EXBLT*-16168 N4	16x16x8 (406x406x203)	2" / M63	7995-1	6 rows of 6 = 36	98 (44.4)	118 (53.5)	HINGE-11L	HINGE-11L
EXBLT*-16248 N4	16x24x8 (406x610x203)	5" / M100	17622	8 rows of 5 = 40	166 (75.3)	213 (96.6)	HINGE-11L	HINGE-11L

Add "P" for aluminum plate cover. Add "C" for sand cast cover.
 Mounting Pan - Order mounting pan as separate item and specify if factory of field installed.
 Note: For Group B applications all conduit must be sealed within 18" of enclosure wall.
 Note: For IEC Ex applications all conduit must be sealed at the wall of the enclosure.

ENCLOSURES

EXBLT SERIES



DIMENSIONS

ENCLOSURE CATALOG NUMBER	INTERNAL DIMENSIONS - INCHES (MM)						EXTERNAL DIMENSIONS - INCHES (MM)			
	PAN		AVAILABLE EQUIPMENT SPACE				F	G	H ("P" PLATE)	H ("C" CAST)
	A	B	C	D	E ("P" PLATE)	E ("C" CAST)				
EXBLT-664 N4	5 (127)	5 (127)	6 (152)	6 (152)	4 (102)	4.25 (108)	10.32 (262)	10.32 (262)	5.94 (151)	6.18 (157)
EXBLT-684 N4	5 (127)	7 (178)	6 (152)	8 (203)	4 (102)	4.32 (110)	10.25 (260)	12.25 (311)	5.88 (149)	6.13 (156)
EXBLT-686 N4	5 (127)	7 (178)	6 (152)	8 (203)	6 (152)	6.32 (160)	10.25 (260)	12.25 (311)	7.88 (200)	8.13 (206)
EXBLT-6124 N4	5 (127)	11 (279)	6.25 (159)	12.25 (311)	4 (102)	4.56 (116)	10.69 (272)	16.69 (424)	5.88 (149)	6.75 (171)
EXBLT-6126 N4	5 (127)	11 (279)	6.25 (159)	12.25 (311)	6 (152)	6.56 (167)	10.69 (272)	16.69 (424)	7.88 (200)	8.75 (222)
EXBLT-886 N4	7 (178)	7 (178)	8 (203)	8 (203)	6 (152)	6.16 (156)	12.32 (313)	12.32 (313)	7.94 (202)	8.34 (212)
EXBLT-8104 N4	7 (178)	9 (229)	8 (203)	10 (254)	4 (102)	4.18 (106)	12.32 (313)	14.32 (364)	5.94 (151)	6.53 (166)
EXBLT-8106 N4	7 (178)	9 (229)	8 (203)	10 (254)	6 (152)	6.18 (157)	12.32 (313)	14.32 (364)	7.94 (202)	8.53 (217)
EXBLT-8126 N4	7 (178)	11 (279)	8.5 (216)	12.5 (318)	6 (152)	6.6 (167)	13.25 (337)	17.25 (438)	8 (203)	8.88 (225)
EXBLT-8128 N4	7 (178)	11 (279)	8.5 (216)	12.5 (318)	8 (203)	8.6 (218)	13.25 (337)	17.25 (438)	10 (254)	10.88 (276)
EXBLT-9116 N4	8 (203)	10 (254)	9 (229)	11 (279)	6 (152)	6.18 (157)	13.32 (338)	15.32 (389)	7.94 (202)	8.53 (217)
EXBLT-10106 N4	9 (229)	9 (229)	10.5 (267)	10.5 (267)	6 (152)	6.41 (163)	15.25 (387)	15.25 (387)	8.18 (208)	9.13 (232)
EXBLT-10108 N4	9 (229)	9 (229)	10.5 (267)	10.5 (267)	8 (203)	8.41 (214)	15.25 (387)	15.25 (387)	10.18 (259)	11.13 (284)
EXBLT-10146 N4	9 (229)	13 (330)	10.5 (267)	14.5 (368)	6 (152)	6.22 (158)	15.25 (387)	19.25 (489)	8.18 (208)	9.13 (232)
EXBLT-10148 N4	9 (229)	13 (330)	10.5 (267)	14.5 (368)	8 (203)	8.22 (209)	15.25 (387)	19.25 (489)	10.18 (259)	11.13 (284)
EXBLT-12126 N4	10.5 (267)	10.5 (267)	11.87(301)	11.87(301)	6 (152)	6.3 (160)	16.38 (416)	16.38 (416)	8.18 (208)	9.06 (230)
EXBLT-12128 N4	10.5 (267)	10.5 (267)	11.87(301)	11.87(301)	8 (203)	8.3 (211)	16.38 (416)	16.38 (416)	10.18 (259)	11.06 (281)
EXBLT-12186 N4	10 (254)	16 (406.4)	11.88 (301)	17.88 (454)	6 (152)	6.09 (155)	16.38 (416)	22.38 (568.4)	8.44 (214.4)	8.97 (228)
EXBLT-12188 N4	10 (254)	16 (406.4)	11.88 (301)	17.88 (454)	8 (203)	8.09 (206)	16.38 (416)	22.38 (568.4)	10.44 (265)	10.97 (279)
EXBLT-12246 N4	10.25 (260)	22.25 (565)	11.88 (301)	23.88 (606)	6 (152)	6.13 (156)	16.38 (416)	28.38 (722)	8.57 (218)	9.28 (236)
EXBLT-12248 N4	10.25 (260)	22.25 (565)	11.88 (301)	23.88 (606)	8 (203)	8.13 (206)	16.38 (416)	28.38 (722)	10.57 (268.5)	11.28 (286)
EXBLT-14148 N4	13 (330)	13 (330)	14.5 (368)	14.5 (368)	8 (203)	8.34 (212)	19.25 (489)	19.25 (489)	10.44 (265)	11.34 (288)
EXBLT-14248 N4	13 (330)	22.25 (565)	14.5 (368)	24.5 (622)	8 (203)	N/A	19.25 (489)	29.25 (743)	10.57 (268.5)	N/A
EXBLT-14308 N4	13 (330)	29 (736)	14.5 (368)	30.5 (775)	8 (203)	N/A	19.25 (489)	35.25 (895.3)	10.57 (268.5)	N/A
EXBLT-16168 N4	14 (355)	14 (355)	15.88 (403)	15.88 (403)	8 (203)	8.14 (207)	20.38 (518)	20.38 (518)	10.44 (265)	11.11 (282)
EXBLT-16248 N4	15 (381)	23 (584)	16.5 (419)	24.5 (622)	8 (203)	8.34 (212)	21.25 (540)	29.25 (743)	10.69 (271.5)	11.91 (302)

All dimensions in. (mm)

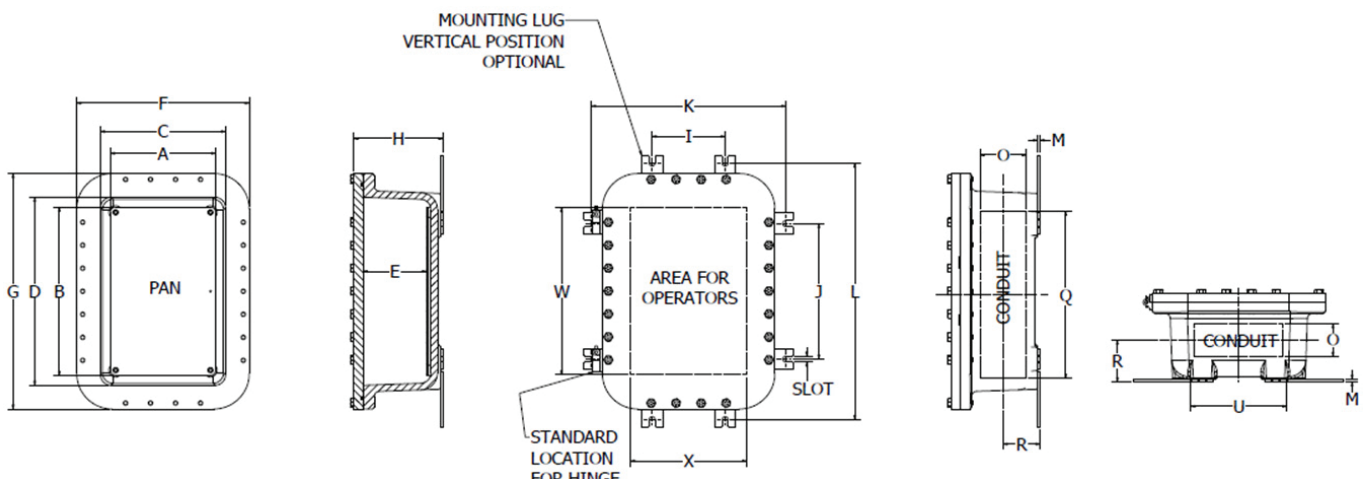



EXBLT SERIES

ENCLOSURE CATALOG NUMBER	MOUNTING DIMENSIONS - INCHES (MM)						CONDUIT AREA - INCHES (MM)					OPERATOR AREA SPECIFICATION		
							SIDE WALL		CENTER	TOP/ BOTTOM WALL				
	I	J	K	L	M	SLOT WIDTH	O	Q	R	S	U	V	W	X
EXBLT-664 N4	N/A	4 (102)	7.88 (200)	N/A	0.19 (5)	0.44 (11)	2.81 (71)	4.72 (120)	2.75 (70)	4.72 (120)	2.5 (63)	5 (127)	5 (127)	5 (127)
EXBLT-684 N4	N/A	4 (102)	7.88 (200)	N/A	0.19 (5)	0.44 (11)	2.81 (71)	6.59 (167)	2.75 (70)	4.59 (117)	2.5 (63)	7 (178)	5 (127)	5 (127)
EXBLT-686 N4	N/A	4 (102)	7.88 (200)	N/A	0.19 (5)	0.44 (11)	4.81 (122)	6.59 (167)	3.75 (95)	4.59 (117)	2.5 (63)	7 (178)	5 (127)	5 (127)
EXBLT-6124 N4	N/A	7.82 (199)	7.88 (200)	N/A	0.19 (5)	0.44 (11)	2.81 (71)	10.84 (275)	2.75 (70)	4.84 (123)	2.5 (63)	11 (279)	5 (127)	5 (127)
EXBLT-6126 N4	N/A	7.82 (199)	7.88 (200)	N/A	0.19 (5)	0.44 (11)	4.81 (122)	10.84 (275)	3.75 (95)	4.84 (123)	2.5 (63)	11 (279)	5 (127)	5 (127)
EXBLT-886 N4	N/A	6 (152)	9.88 (251)	N/A	0.19 (5)	0.44 (11)	4.81 (122)	6.56 (167)	3.75 (95)	6.56 (167)	2.5 (63)	7 (178)	7 (178)	7 (178)
EXBLT-8104 N4	N/A	8 (203)	9.88 (251)	N/A	0.19 (5)	0.44 (11)	2.81 (71)	8.56 (217)	2.75 (70)	6.56 (167)	2.5 (63)	9 (229)	7 (178)	7 (178)
EXBLT-8106 N4	N/A	8 (203)	9.88 (251)	N/A	0.19 (5)	0.44 (11)	4.81 (122)	8.56 (217)	3.75 (95)	6.56 (167)	2.5 (63)	9 (229)	7 (178)	7 (178)
EXBLT-8126 N4	3.82 (97)	7.82 (199)	10.38 (264)	14.38 (365)	0.19 (5)	0.44 (11)	3.94 (100)	10.13 (257)	3.95 (100)	6.13 (156)	2.5 (63)	11 (279)	7 (178)	7 (178)
EXBLT-8128 N4	3.82 (97)	7.82 (199)	10.38 (264)	14.38 (365)	0.19 (5)	0.44 (11)	5.94 (151)	9.97 (253)	4.95 (126)	5.97 (152)	2.5 (63)	11 (279)	7 (178)	7 (178)
EXBLT-9116 N4	N/A	7.5 (191)	10.88 (276)	N/A	0.19 (5)	0.44 (11)	4.81 (122)	9.56 (243)	3.81 (97)	7.56 (192)	2.5 (63)	10 (254)	8 (203)	8 (203)
EXBLT-10106 N4	4.94 (125)	4.94 (125)	12.94 (329)	12.94 (329)	0.25 (6)	0.56 (14)	3.94 (100)	8.13 (206)	4.09 (104)	8.13 (206)	2.5 (63)	9 (229)	9 (229)	9 (229)
EXBLT-10108 N4	4.94 (125)	4.94 (125)	12.94 (329)	12.94 (329)	0.25 (6)	0.56 (14)	5.94 (151)	7.97 (202)	5.09 (129)	7.97 (202)	2.5 (63)	9 (229)	9 (229)	9 (229)
EXBLT-10146 N4	4.94 (125)	8.94 (227)	12.94 (329)	16.94 (430)	0.25 (6)	0.56 (14)	3.94 (100)	12.13 (308)	4.09 (104)	8.13 (206)	2.5 (63)	13 (330)	9 (229)	9 (229)
EXBLT-10148 N4	4.94 (125)	8.94 (227)	12.94 (329)	16.94 (430)	0.25 (6)	0.56 (14)	5.94 (151)	11.97 (303)	5.09 (129)	7.97 (202)	2.5 (63)	13 (330)	9 (229)	9 (229)
EXBLT-12126 N4	6.94 (176)	6.94 (176)	14.94 (379)	14.94 (379)	0.25 (6)	0.56 (14)	3.94 (100)	9.5 (241)	4.09 (104)	9.5 (241)	2.5 (63)	10 (254)	10 (254)	10 (254)
EXBLT-12128 N4	6.94 (176)	6.94 (176)	14.94 (379)	14.94 (379)	0.25 (6)	0.56 (14)	5.94 (151)	9.34 (237)	5.09 (129)	9.34 (237)	2.5 (63)	10 (254)	10 (254)	10 (254)
EXBLT-12186 N4	6.94 (176)	12.88 (327)	14.94 (379)	20.88 (530)	0.25 (6)	0.56 (14)	3.88 (98)	15.5 (394)	4.03 (102)	9.5 (241)	2.5 (63)	16 (406)	10 (254)	10 (254)
EXBLT-12188 N4	6.94 (176)	12.88 (327)	14.94 (379)	20.88 (530)	0.25 (6)	0.56 (14)	5.88 (149)	15.34 (390)	5.03 (128)	9.34 (237)	2.5 (63)	16 (406)	10 (254)	10 (254)
EXBLT-12246 N4	6.94 (176)	18.88 (480)	14.91 (379)	26.88 (683)	0.25 (6)	0.56 (14)	3.88 (98)	21.5 (546)	4.03 (102)	9.5 (241)	2.5 (63)	22.3 (565)	10 (254)	10 (254)
EXBLT-12248 N4	6.94 (176)	18.88 (480)	14.91 (379)	26.88 (683)	0.25 (6)	0.56 (14)	5.88 (149)	21.34 (542)	5.03 (128)	9.34 (237)	2.5 (63)	22.3 (565)	10 (254)	10 (254)
EXBLT-14148 N4	9.00 (229)	9.00 (229)	17 (432)	17 (432)	0.25 (6)	0.56 (14)	5.94 (151)	11.97 (304)	5.09 (129)	11.97 (304)	2.5 (63)	13 (330)	13 (330)	13 (330)
EXBLT-14248 N4	9.00 (229)	19.38 (492)	17 (432)	27.38 (695)	0.25 (6)	0.56 (14)	5.88 (149)	21.97 (686)	5.16 (131)	11.97 (304)	2.5 (63)	22 (559)	13 (330)	13 (330)
EXBLT-14308 N4	9.00 (229)	26.25 (668)	17 (432)	34.25 (870)	0.25 (6)	0.56 (14)	5.94 (151)	27.97 (710)	5.19 (132)	11.97 (304)	2.5 (63)	28 (711)	13 (330)	13 (330)
EXBLT-16168 N4	10.94 (278)	10.94 (278)	17.19 (437)	18.94 (481)	0.25 (6)	0.56 (14)	5.94 (151)	13.34 (339)	5.06 (129)	13.34 (339)	2.5 (63)	14 (356)	14 (356)	14 (356)
EXBLT-16248 N4	10.94 (278)	19.38 (492)	19.38 (492)	27.38 (695)	0.25 (6)	0.56 (14)	5.94 (151)	21.97 (686)	5.31 (135)	13.97 (355)	2.5 (63)	22 (559)	14 (356)	14 (356)

'USE "LONG" STYLE GZ OR GO SERIES CONTROL OPERATORS

All dimensions in. (mm)

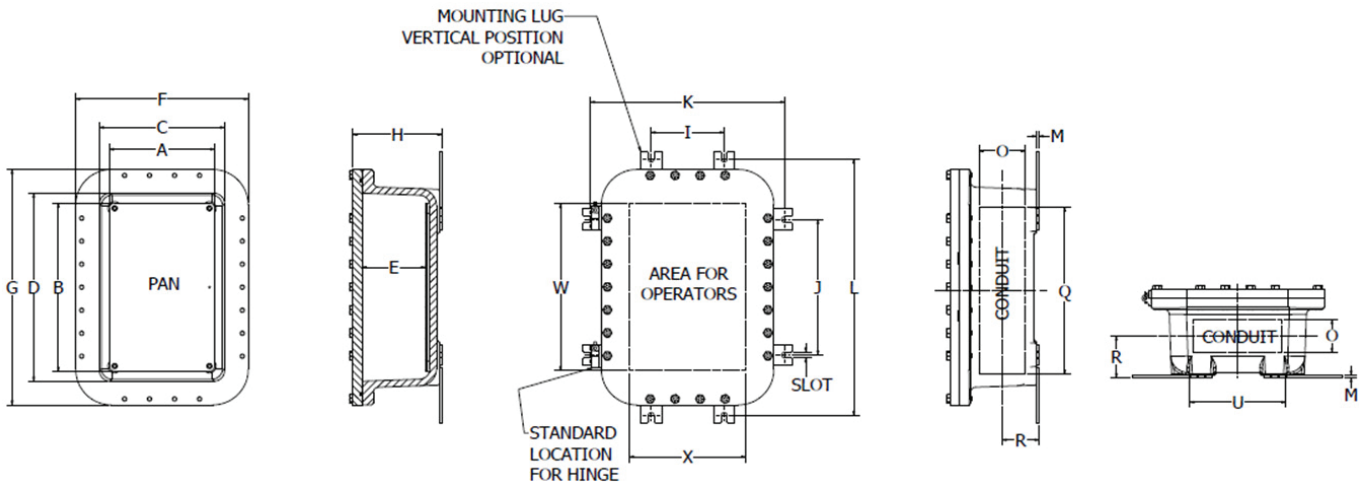

ENCLOSURES

EXBLT SERIES



REPLACEMENT PARTS

ENCLOSURE CATALOG NUMBER	COVER GASKET	MOUNTING LUG KIT (Contains four mounting lugs and hardware)	REPLACEMENT PARTS						HINGES	
			COVER BOLTS – SOLD PER EACH						EXBLTP BOXES (*) ADD “L” FOR LEFT OR “R” FOR RIGHT	EXBLTC BOXES (*) ADD “L” FOR LEFT OR “R” FOR RIGHT
			NO. OF BOLTS PER ENCLOSURE	CARBON STEEL “N4”	316 STAINLESS STEEL “N4X”	316 STAINLESS STEEL TRI-LEAD PLATE COVERS “N4XTL”	316 STAINLESS STEEL TRI-LEAD CAST COVERS “N4XTL”	ATEX IEC EX 316 STAINLESS STEEL “N4CEN”		
EXBLT*-664 N4	EXB66RG	EXB-MTL1	8	0725115B	25952BAAB	xxxxx	xxxxx	20790AAAB	HINGE-12*	HINGE-12*
EXBLT*-684 N4	EXB68RG	EXB-MTL1	10	0725115B	25952BAAB	xxxxx	xxxxx	20790AAAB	HINGE-12*	HINGE-12*
EXBLT*-686 N4	EXB68RG	EXB-MTL1	10	0725115B	25952BAAB	xxxxx	xxxxx	20790AAAB	HINGE-12*	HINGE-12*
EXBLT*-6124 N4	EXB612RG	EXB-MTL1	12	0720361B	25952AAAB	25904AAAB	17339AAAB	20790BAAB	HINGE-12*	HINGE-12*
EXBLT*-6126 N4	EXB612RG	EXB-MTL1	12	0720361B	25952AAAB	25904AAAB	17339AAAB	20790BAAB	HINGE-12*	HINGE-12*
EXBLT*-886 N4	EXB88RG	EXB-MTL1	12	0725115B	25952BAAB	xxxxx	xxxxx	20790AAAB	HINGE-12*	HINGE-12*
EXBLT*-8104 N4	EXB810RG	EXB-MTL1	14	0725115B	25952BAAB	xxxxx	xxxxx	20790AAAB	HINGE-12*	HINGE-12*
EXBLT*-8106 N4	EXB810RG	EXB-MTL1	14	0725115B	25952BAAB	xxxxx	xxxxx	20790AAAB	HINGE-12*	HINGE-12*
EXBLT*-8126 N4	EXB812RG	EXB-MTL1	12	0720361B	25952AAAB	25904AAAB	17339AAAB	20790BAAB	HINGE-12*	HINGE-11*
EXBLT*-8128 N4	EXB812RG	EXB-MTL1	12	0720361B	25952AAAB	25904AAAB	17339AAAB	20790BAAB	HINGE-12*	HINGE-11*
EXBLT*-9116 N4	EXB911RG	EXB-MTL1	14	0725115B	25952BAAB	xxxxx	xxxxx	20790AAAB	HINGE-12*	HINGE-12*
EXBLT*-10106 N4	EXB1010RG	EXB-MTL2	12	0720361B	25952AAAB	25904AAAB	17339AAAB	20790BAAB	HINGE-12*	HINGE-11*
EXBLT*-10108 N4	EXB1010RG	EXB-MTL2	12	0720361B	25952AAAB	25904AAAB	17339AAAB	20790BAAB	HINGE-12*	HINGE-11*
EXBLT*-10146 N4	EXB1014RG	EXB-MTL2	16	0720361B	25952AAAB	25904AAAB	17339AAAB	20790BAAB	HINGE-12*	HINGE-11*
EXBLT*-10148 N4	EXB1014RG	EXB-MTL2	16	0720361B	25952AAAB	25904AAAB	17339AAAB	20790BAAB	HINGE-12*	HINGE-11*
EXBLT*-12126 N4	EXB1212RG	EXB-MTL2	16	0720361B	25952AAAB	25904AAAB	17339AAAB	20790BAAB	HINGE-12*	HINGE-11*
EXBLT*-12128 N4	EXB1212RG	EXB-MTL2	16	0720361B	25952AAAB	25904AAAB	17339AAAB	20790BAAB	HINGE-12*	HINGE-11*
EXBLT*-12186 N4	EXB1218RG	EXB-MTL2	28	0720361B	25952AAAB	25904AAAB	17339AAAB	20790BAAB	HINGE-11*	HINGE-11*
EXBLT*-12188 N4	EXB1218RG	EXB-MTL2	28	0720361B	25952AAAB	25904AAAB	17339AAAB	20790BAAB	HINGE-11*	HINGE-11*
EXBLT*-12246 N4	EXB1224RG	EXB-MTL2	36	0720361B	25952AAAB	25904AAAB	17339AAAB	20790BAAB	HINGE-11*	HINGE-11*
EXBLT*-12248 N4	EXB1224RG	EXB-MTL2	36	0720361B	25952AAAB	25904AAAB	17339AAAB	20790BAAB	HINGE-11*	HINGE-11*
EXBLT*-14148 N4	EXB1224RG	EXB-MTL2	20	0720361B	25952AAAB	25904AAAB	17339AAAB	20790BAAB	HINGE-11*	HINGE-11*
EXBLT*-14248 N4	EXB1224RG	EXB-MTL2	28	0720361B	25952AAAB	25904AAAB	17339AAAB	20790BAAB	HINGE-11*	HINGE-11*
EXBLT*-14308 N4	EXB1224RG	EXB-MTL2	36	0720361B	25952AAAB	25904AAAB	17339AAAB	20790BAAB	HINGE-11*	HINGE-11*
EXBLT*-16168 N4	EXB1224RG	EXB-MTL2	24	0720361B	25952AAAB	25904AAAB	17339AAAB	20790BAAB	HINGE-11*	HINGE-11*
EXBLT*-16248 N4	EXB1224RG	EXB-MTL2	30	0720361B	25952AAAB	25904AAAB	17339AAAB	20790BAAB	HINGE-11*	HINGE-11*

Hinges

Hinges are provided as a standard on EXBLT*-6124, EXBLT*-6126 and sizes EXBLT*-8126 and larger. See chart for replacement hinge catalog number. Sold in sets of (2).

“G” Series Operators

The EXBLT* uses the GZ Long Style operators.

Touch-Up Paint

The touch-up paint comes in a 12 oz aerosol can.

Wet lacquer silver gray touch-up paint: KTPALS.

Epoxy powder gray touch-up paint: KTPEPG.