

4C EDS / EFS Series Control Stations

FlexStation™ Control Station Components

Cl. I, Div. 1 & 2, Groups B (Div. 2 only) C, D
 Cl. II, Div. 1 & 2, Groups E, F, G
 Cl. III
 Zone 1 & 2 Group IIB
 NEMA 3R, 7B* (Div. 2) CD, 9 EFG, 12

Applications:

Five modular components – operators, contact blocks, covers, legend plates, and bodies – are combined to provide a variety of control stations which are:

- For use indoors or outdoors, in areas which are hazardous due to the presence of flammable gases and vapors, or combustible dust.
- Used in conjunction with magnetic starters or contactors for remote control of motors and other electrical apparatus.
- For installation in petroleum refineries, chemical, petrochemical, and other industrial process facilities; grain processing and storage facilities; and other heavy industrial applications where Class I, Class II, or Class III hazards are present.

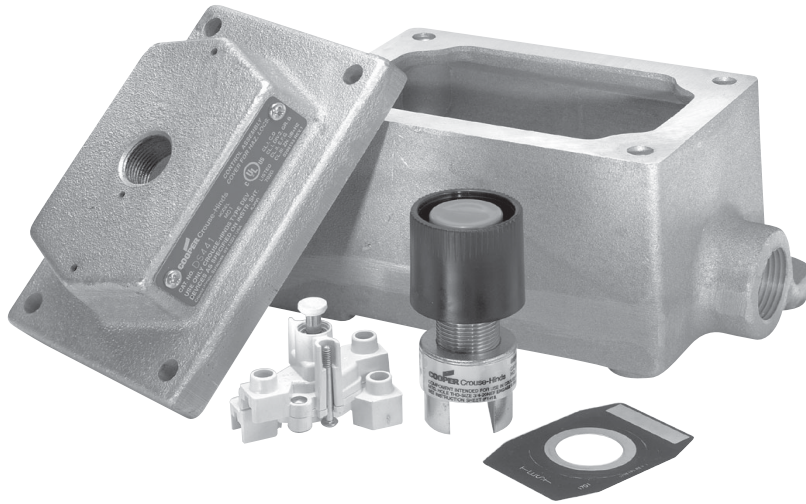

Features:

- Momentary contact pushbuttons, maintained contact pushbuttons, and pilots lights offer a choice of functions.
- Selector switches in 2 or 3 position configurations including keyed and spring return options.
- Single-hole, two-hole, and three-hole covers for one, two, or three devices respectively per station.
- Rugged control devices for safe, reliable operation in industrial applications.
- Bodies, with extra room for wire pulling and termination, also include two integral mounting feet for fast, secure installation.
- Bodies have 1/2", 3/4", or 1" dead-end or through-feed conduit hubs with integral bushing for protection of wire insulation.
- Covers and bodies are available in *Feraloy*® or copper-free aluminum for light weight and corrosion resistance.
- DL legend plates have large lettering to give clear indication of device function. Space is available for field markings.

Certifications and Compliances:

- NEC
 Class I, Division 1 & 2, Groups B* (Div. 2), C, D
 Class II, Division 1 & 2, Groups E, F, G
 Class III
- Zone 1 & 2 Group IIB*
- NEMA: 3R, 7B (Div. 2) CD, 9EFG, 12
- UL Standard: 1203

Standard Materials:

- Bodies, covers – *Feraloy*® or copper-free aluminum.
- Pushbuttons and guards – Type 6 / 6 nylon.
- Operating shafts, bearings – stainless steel.

Standard Finishes:

- *Feraloy*® iron alloy – electrogalvanized and aluminum acrylic paint.
- Copper-free aluminum – natural.
- Stainless steel – natural.

Options:

Description	Suffix
Copper-free aluminum bodies and covers	SA
Corro-free™ epoxy finish for use in severely corrosive environments.	S752
FlexStation covers and bodies.	

Electrical Ratings:

- Pushbuttons and selector switches – 600 VAC heavy duty (NEMA A600).
- Pilot lights – 120 VAC.

Dimensions In Inches:

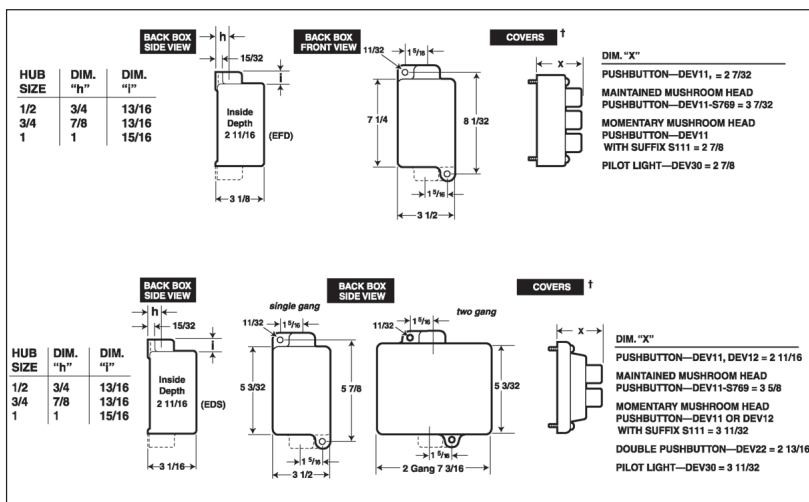

EDS / EFS Series Control Stations

FlexStation™ Control Station Components

Cl. I, Div. 1 & 2, Groups B (Div. 2 only) C, D
Cl. II, Div. 1 & 2, Groups E, F, G
Cl. III
Zone 1 & 2 Group IIB
NEMA 3R, 7B* (Div. 2) CD, 9 EFG, 12

4C

4C

STEP 1 – Select Operator

Pushbutton – front operated, standard black button



Description	Cat. #
Single button for 1 contact block	DEV11
Single button for 2 contact blocks	DEV12
Double buttons for 2 contact blocks	DEV22

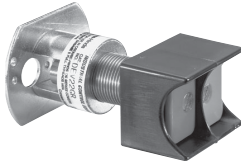

Options	Suffix
Specify color for each pushbutton button (ex: DEV11G, DEV22GR). Color is black if unspecified.	
Green button - unmarked	G
Red button - unmarked	R
Momentary red mushroom head (breaks normally closed contacts only, not available with lockout or DEV22)	S111
Lockout with bar and chain (available on DEV11 and DEV12)	S153
Maintained red mushroom head (breaks normally closed and makes normally open contacts, push to stop, lockout standard, not available with DEV22)	S769

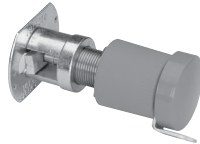

Pilot Light – factory sealed, incandescent lamp



Description	Cat. #
Pilot light with red jewel	DEV30 J1
Pilot light with green jewel	DEV30 J3
Pilot light with amber jewel	DEV30 J6
Pilot light with clear jewel	DEV30 J10
Pilot light with blue LED and clear jewel	DEV30 J11 LED



Options	Suffix
LED lamps (standard clear jewel with colored lamp)	LED
24 V lamp (not available with transformer feature)	S300
240 / 120 V pilot light transformer	T2
480 / 120 V pilot light transformer	T4
600 / 120 V pilot light transformer	T5

Selector Switch – with standard lockout



Description	Cat. #
2-position (pos. 1 – N.O., pos. 2 – N.C.) for use with 1 or 2 contact blocks	DEV42
3-position (pos. 1 – N.O., pos. 2 – Open, pos. 3 – N.C.) for use with 1 or 2 contact blocks	DEV43
3-position (pos. 1 – N.C., pos. 2 – N.O., pos. 3 – N.O. for Switch A) (pos. 1 – N.O., pos. 2 – N.O., pos. 3 – N.C. for Switch B) for use with 2 contact blocks	DEV44

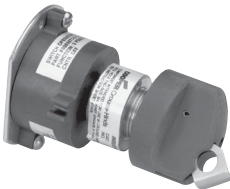

Options	Suffix
Spring return to center from right (For DEV43 or DEV44 only)	S634
Spring return to center from left (For DEV43 or DEV44 only)	S635
Spring return to center from right and left (For DEV43 or DEV44 only)	S842
Key Operated – removable from all positions	S847 K1*
Key Operated – removable from left position for DEV42 or from center for DEV43 and DEV44	S847 K2*
Key Operated – removable from right position for DEV42 or from left for DEV43 and DEV44	S847 K3*
Key Operated – removable from right position for DEV43 and DEV44	S847 K4*

*Additional key lock housings available; please contact Customer Service.

STEP 2 – Select Contact Block (if required). For product details see page 571.

Contact Block



Description	Cat. #
Contact block, 1 NO and 1 NC, 10A, 600VAC, A600 rating	ESWP126

For additional technical information see page 571.

Note - Each control station will accept a maximum of three contact blocks. Select device operators accordingly. DEV12, DEV22 and DEV44 may not be used on a three-operator (DS443-SA) cover. DEV42 and DEV43 may not be used on a three-operator cover when using them with two contact blocks.

4C

EDS / EFS Series Control Stations

FlexStation™ Control Station Components

Cl. I, Div. 1 & 2, Groups B (Div. 2 only) C, D
Cl. II, Div. 1 & 2, Groups E, F, G
Cl. III
Zone 1 & 2 Group IIB
NEMA 3R, 7B* (Div. 2) CD, 9 EFG, 12

4C

STEP 3 – Select Desired Legend Plates

For use with single hole covers

Cat. #	Inscription
DL101	Blank
DL128	Run-Jog
DL129	Hand-Auto
DL130	Forward-Reverse
DL132	Open-Close
DL133	Up-Down
DL135	In-Out
DL136	Raise-Lower
DL137	Start-Stop
DL138	Run-Off-Jog
DL139	Hand-Off-Auto
DL140	For-Off-Rev
DL141	Fast-Off-Slow
DL142	1-Off-2
DL143	Open-Off-Close
DL144	Up-Off-Down
DL148	Off-On
DL149	Auto-Off-Hand
DL165	Slow-Fast
DL186	Safe-Run
DL187	Raise-Off-Lower
DL188	Slow-Off-Fast
DL189	Odd-Off-Even
DL190	Stop-Start
DL191	On-Off
DL192	Fast-Slow
DL193	Local-Remote
DL194	Trip-Reset
DL195	Auto-Manual
DL196	Start-Emer Stop
DL197	Alarm-Silence
DL198	Maint-Manual
DL199	Test-Reset

For use with 2 or 3 hole covers

Cat. #	Inscription	Cat. #	Inscription
DL01	Blank w/no fields	DL32	Open-Close
DL02	Blank w/single field	DL33	Up-Down
DL03	Blank w/2 fields	DL35	In-Out
DL05	Start	DL36	Raise-Lower
DL06	Stop	DL37	Start-Stop
DL07	On	DL38	Run-Off-Jog
DL08	Off	DL39	Hand-Off-Auto
DL09	Run	DL40	For-Off-Rev
DL10	Jog	DL41	Fast-Off-Slow
DL11	Trip	DL42	1-Off-2
DL12	Reset	DL43	Open-Off-Close
DL13	Test	DL44	Up-Off-Down
DL14	Power On	DL46	Fast
DL15	Hand	DL47	Slow
DL16	Automatic	DL48	Off-On
DL17	Emer Stop	DL49	Auto-Off-Hand
DL18	Forward	DL65	Slow-Fast
DL19	Reverse	DL85	Safe
DL20	Open	DL86	Safe-Run
DL21	Close	DL87	Raise-Off-Lower
DL22	Up	DL88	Slow-Off-Fast
DL23	Down	DL89	Odd-Off-Even
DL24	In	DL90	Stop-Start
DL25	Out	DL91	On-Off
DL26	Raise	DL92	Fast-Slow
DL27	Lower	DL93	Local-Remote
DL28	Run-Jog	DL94	Trip-Reset
DL29	Hand-Auto	DL95	Auto-Manual
DL30	Forward-Reverse	DL96	Start-Emer Stop
		DL97	Alarm-Silence
		DL98	Maint-Manual
		DL99	Test-Reset

Note: For special markings order DL101-"desired markings" or DL01-"desired markings"

STEP 4 – Select Cover Covers

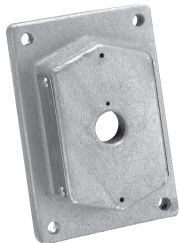

Description	Cat. #
Blank cover with single hole (Single gang)	DS441
Blank cover with 2 holes (Single gang)	DS442
Blank cover with 3 holes (To be used with EFD(C)1491-SA, 2491-SA or 3491-SA series of back boxes)	DS443 SA
Replacement cover plug for unused device operator openings	206765



Options:	Suffix
Aluminum body (mandatory suffix on DS443 must be included in catalog number)	SA
Exterior epoxy powder coat finish	S752
Interior & exterior epoxy powder coat finish. Not available on three operator cover (DS443-SA)	S753

EDS / EFS Series Control Stations

FlexStation™ Control Station Components

Cl. I, Div. 1 & 2, Groups B (Div. 2 only) C, D
 Cl. II, Div. 1 & 2, Groups E, F, G
 Cl. III
 Zone 1 & 2 Group IIB
 NEMA 3R, 7B* (Div. 2) CD, 9 EFG, 12

4C

STEP 5 – Select Back Box

Back Boxes - for use with DS441 and DS442 covers or with 1 gang and 2 gang DS/DSD Series covers



Dead End	Through Feed	Hub Size	Back Box Arrangement
EDS171	EDSC171	1/2"	Single gang back box
EDS271	EDSC271	3/4"	Single gang back box
EDS371	EDSC371	1"	Single gang back box
EDS172	EDSC172	1/2"	Double gang back box
EDS272	EDSC272	3/4"	Double gang back box
EDS372	EDSC372	1"	Double gang back box

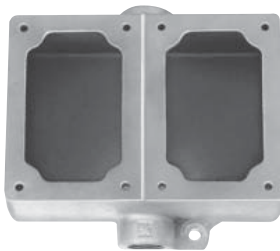

Options:	Suffix
Aluminum body	SA
Exterior epoxy powder coat finish	S752
Interior & exterior epoxy powder coat finish	S753

4C

Back Boxes – for use with DS443-SA cover or with 1½ gang DS511 (3-operator) Series covers

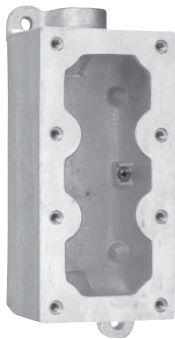

Dead End	Through Feed	Hub Size	Back Box Arrangement
EFD1491 SA	EFDC1491 SA	1/2"	1½ gang back box
EFD2491 SA	EFDC2491 SA	3/4"	1½ gang back box
EFD3491 SA	EFDC3491 SA	1"	1½ gang back box

Options	Suffix
Exterior epoxy powder coat finish	S752
Interior & exterior epoxy powder coat finish	S753

4C EDS / EFS Series Control Stations

FlexStation™ Control Station Components

Cl. I, Div. 1 & 2, Groups B (Div. 2 only) C, D
 Cl. II, Div. 1 & 2, Groups E, F, G
 Cl. III
 Zone 1 & 2 Group IIB
 NEMA 3R, 7B* (Div. 2) CD, 9 EFG, 12

Back Boxes – for use with DS441 and DS442 covers



Through Feed	Hub Size	Back Box Arrangement
EDSC378	1"	3 gang tandem

Common Cover Assemblies

Cat. #	Description
DS455 ①	With one pilot light
DS476 ① ②	With one pilot light and transformer
DS456 ① ①	With two pilot lights
DS429§	With one pushbutton
DS454§	With two pushbuttons
DS510 ①§	With one pushbutton and one pilot light

①Add color symbol for each pilot light from table below.

Color	Symbol	Color	Symbol	Color	Symbol
Red	J1	Amber	J6	Blue	J11
Green	J3	Clear	J10		

②Add suffix below for transformer primary voltage:

Transformers – Voltages above 125

Nom. Volts 50–60Hz Transformer	Primary Voltage Range	Suffix
220 / 110	220–240	T2
440 / 110	440–480	T4
550 / 110	550–600	T5

§ If desired, markings on indicating plates may be added to catalog number. Select from the list of standard markings below:

START	OFF	RESET	LIGHT ON
STOP	RUN	TRIP	HAND
ON	JOG	TEST	AUTOMATIC
EMERGENCY	OPEN	DOWN	RAISE
FORWARD	CLOSE	IN	LOWER
REVERSE	UP	OUT	

EDS / EFS Series Control Stations

DSD Cover and Device Sub-assemblies

Cl. I, Div. 1 & 2, Groups B*, C, D†
Cl. II, Div. 1, Groups E, F, G
Cl. II, Div. 2, Groups F, G
Cl. III
NEMA 3, 7B*CD, 9EFG

Explosionproof
Dust-Ignitionproof
Raintight
Wet Locations

4C

For use with EDSCM modular control device bodies see page 519 and EDS/EDSC back boxes.

Features:

- Large machine screws for fastening covers to bodies
- Lockout hole for padlock having 1/4" hasp is provided when used with covers for front lever and side rocker type operation
- Lockout provisions on front operated pushbutton (marked "STOP" and "OFF") and all selector switch covers
- For covers with front lever and side rocker type operating handles, threaded type shafts and bushings are used to ensure flametightness
- Accurately ground flange for flametight joint when mated with ground flange on back box

Certifications and Compliances:

(When used with EDSCM & EDS bodies):

- NEC/CEC:
 - Class I, Division 1 & 2, Groups C, D†
 - Class I, Division 2, Groups B, C, D
 - Class II, Division 1, Groups E, F, G
 - Class II, Division 2, Groups F, G
 - Class III
- NEMA/EEMAC: 3, 7B (Div. 2) CD, 9EFG
- UL Standards: 894, 698
- CSA Standard: C22.2 No. 30

Pushbuttons, Pilot Lights & Selector Switches (when used with EFS bodies):

- NEC/CEC:
 - Class I, Division 1 & 2, Groups B, C, D
 - Class II, Division 1, Groups E, F, G
 - Class II, Division 2, Groups F, G
 - Class III
- NEMA/EEMAC: 3, 7BCD, 9EFG
- UL Standard: 1203
- CSA Standard: C22.2 No. 30

Standard Materials:

- Covers, front operated – Feraloy iron alloy and copper-free aluminum
- Covers, side operated – copper-free aluminum
- Shafts and shaft bushings – stainless steel
- Rocker handles, pushbuttons and guards – type 6 / 6 nylon
- Sealing enclosures – copper-free aluminum

CPS delayed action receptacle cover:

- Receptacle housing – copper-free aluminum
- Insulation – diallyl phthalate (DAP)
- Contacts – brass

Standard Finishes:

- Feraloy – electrogalvanized and aluminum acrylic paint
- Copper-free aluminum – natural



Options:

The following special options are available by adding suffix to Cat. #:

Description	Suffix
• Lockout provision on front operated pushbutton cover (standard on buttons marked "STOP" and "OFF").....	S153
• Three-position selector switches with modified operation: Momentary contact clockwise operation, spring return to center, maintained contact counter-clockwise operation.....	S634
Momentary contact counter-clockwise operation, spring return to center, maintained contact clockwise operation.....	S635
• Momentary red emergency "STOP" button – front operated mushroom button, breaks normally closed contacts only (DL02 legend plate included – must specify legend text).....	S111
• Bodies and covers – copper-free aluminum.....	SA
• For 24 VDC operation on pilot lights.....	S300
• Maintained red emergency "STOP" button with lockout – front operated mushroom button breaks normally closed and makes normally open contacts (push to stop), lockout standard (will not fit with a pilot light if transformer is required).....	S769
• Spring return to center from right and left (For DEV43 or DEV44 only).....	S842
• Key Operated – removable from all positions.....	S847 K1†
• Key Operated – removable from left position for DEV42 or from center for DEV43 and DEV44.....	S847 K2†
• Key Operated – removable from right position for DEV42 or from left for DEV43 and DEV44.....	S847 K3†
• Key Operated – removable from right position for DEV43 and DEV44.....	S847 K4†

4C

Ordering Information: Manual Motor Starters

Poles	Max. H.P.	Max. Volts A.C.	Cat. #
With Allen-Bradley Bulletin 600 Switches			
1	1	115–230	DSD910 ①
2	1	115–230	DSD911 ①
With General Electric Switches			
1	1	115–230	DSD912 ①§
2	1	115–230	DSD913 ①§
With Cutler-Hammer Switches			
1	1	115–230	DSD914 ①§
2	1	115–230	DSD915 ①§
With Arrow-Hart Switches Without Overload Protection			
2	5	250 (30A)	DSD916
2	7.5	600 (30A)	DSD916
3	7.5	250 (30A)	DSD917
3	15	600 (20A)	DSD917



† When a CPS receptacle cover device is used, the assembly meets requirements for Class I, Groups C and D areas only.

* For pushbuttons, pilot lights, & selector switches, use EFS back box with required external conduit seal for 1 inch hub size, within 5 feet for Class I, Division 1, Group B applications.

‡ Additional key lock housings available; please contact Customer Service.

§ A comparable factory sealed cover will fit on the EDSCM21 body, EDS and EDSC bodies and in bottom gang of EDSCM33 and EDSCM63 bodies. To order, add suffix S701 to catalog number.

① Includes one interchangeable heater. To select heater see pages 479–480. Symbol 0 (zero) may be used to indicate heater omitted.

4C

EDS / EFS Series Control Stations

DSD Cover and Device Sub-Assemblies

Cl. I, Div. 1 & 2, Groups B*, C, D†
 Cl. II, Div. 1, Groups E, F, G
 Cl. II, Div. 2, Groups F, G
 Cl. III
 NEMA 3, 7B*CD, 9EFG

Explosionproof
 Dust-Ignitionproof
 Raintight
 Wet Locations

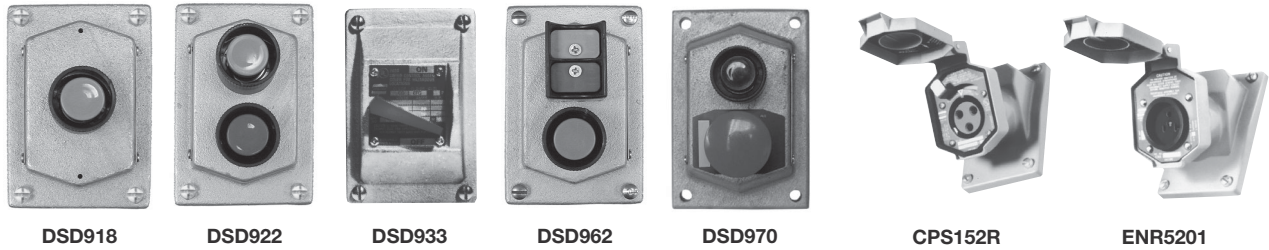

For use with EDSCM modular control device bodies see page 519 & EFS/EDS back boxes.

Ordering Information

Front Operated Pushbutton Stations 600 VAC Heavy Duty, Factory Sealed

Number of Cover Buttons	Normal Position	Diagram	Cat. #
1	1 Circuit Universal		DSD918 ①
1	2 Circuits Universal		DSD919 ①
2	2 Circuits Universal		DSD920 ①■
2	2 Circuits Universal		DSD921 ①
2	2 Circuits Start-Stop unless otherwise specified		DSD922 ①■
2	2 Circuits Universal Mushroom Head		DSD970 ①
3 (2-operator)	3 Circuits Universal		DSD962 ①
3 (3-operator)	3 Circuits Universal		DS511 ① SA\$
3 (3-operator)	3 Circuits Universal Double pilot light - single pushbutton combo		DS513 ① SA\$
3 (3-operator)	3 Circuits Universal Double pushbutton - single pilot light combo		DS514 ① SA\$

Front Operated General Use Snap Switch

Style	Amperes 120 VAC	277 VAC	Cat. #
1-Pole	20	20	DSD933‡
2-Pole	20	20	DSD934‡
3-Pole	▲	▲	DSD935Ⓞ
3-Way	20	20	DSD936‡
4-Way	20	20	DSD937‡
1-Pole	30	30	DSD939‡
2-Pole	30	30	DSD940‡
3-Way	30	30	DSD941‡

Delayed Action Receptacles Factory Sealed

Rating	Cat. #
20 A, 1 HP, 125-250 VAC 60 Hertz 20 A, 18 VDC	CPS152R (2 wire, 3 pole)
30 A, 1 1/2 HP, 125-250 VAC 60 Hertz; 7 A, 1/2 HP, 480 VAC, 60 Hertz	CPS532R (2 wire, 3 pole)
30 A, 3 HP, 125-250 VAC 60 Hertz; 7A, 1 HP, 480 VAC, 60 Hertz	CPS732R (3 wire, 4 pole)

General Purpose, Dead Front Factory Sealed

Rating	Cat. #	Diagram
20 A, 125 VAC	ENR5201	
20 A, 250 VAC	ENR6202	

① If desired, markings on indicating plates may be added to catalog number. Select from the list of standard markings below:

START	OFF	RESET	LIGHT ON
STOP	RUN	TRIP	HAND
ON	JOG	TEST	AUTOMATIC
EMERGENCY	OPEN	DOWN	RAISE
FORWARD	CLOSE	IN	LOWER
REVERSE	UP	OUT	

* For pushbuttons, pilot lights, & selector switches, use EFS back box with required external conduit seal for 1 inch hub size, within 5 feet for Class I, Division 1, Group B applications.

† When a CPS receptacle cover device is used, the assembly meets requirements for Class I, Groups C and D areas only.

■ Two universal contact blocks, must be wired as two circuits with one normally open and one normally closed. 1 green button, 1 red button, and lockout provision provided as standard.

▲ 16 Amp., 125V.
 10 Amp., 250V.

‡ To order a comparable factory sealed cover for EDS, EDSC, EDSCM21 and the bottom gang of EDSCM33 and EDSCM63 bodies, add suffix S697. Factory sealed for Class I, Division 2, Group B.

Ⓞ Cannot be factory sealed.

§ Can only be used with EFD Series 1 1/2" gang back boxes. Pushbuttons include contact blocks. Standard pushbutton color is black. For optional colors - red, green - write in color. Example: DS511 GREEN BLACK RED-SA. First color is for uppermost button. For optional legend markings write in marking after device operator color. Example: DS513-J3 JOG-J1 STOP GREEN-SA.

EDS / EFS Series Control Stations

DSD Cover and Device Sub-Assemblies

Cl. I, Div. 1 & 2, Groups B*, C, D Explosionproof
 Cl. II, Div. 1, Groups E, F, G Dust-Ignitionproof
 Cl. II, Div. 2, Groups F, G Raintight
 Cl. III Wet Locations
 NEMA 3, 7B*CD, 9EFG

4C



DSD951



DSD925



DSD947-J1-J1



DSD958



DSD957



DSD961-J1

For use with EDSCM modular control device bodies see page 519 & EFS/EDS back boxes.

Ordering Information Side Operated Pushbutton Station 600 VAC Heavy Duty, Factory Sealed

Normal Position	Diagram	Cat. #
1 Circuit Universal		DSD949 ③
2 Circuits Universal		DSD950 ③
2 Circuits 1 Open - A 1 Closed - B		DSD951 ③

Start-Stop unless otherwise specified

Selector Switches Maintained Contact 600 VAC Heavy Duty, Factory Sealed

Style	Position 1	Position 2	Position 3	Cat. #
Two Circuit	A1	A2		DSD923 ④
Two Position Four Circuit	A1	A2	B1	DSD924 ④
	A2	B2		
Two Circuit	A1	A2		DSD925 ④
Three Position	A1	A2	B1	DSD926 ④
	B2			
Four Circuit	A1	A2	B1	DSD927 ④
	B2			

* For pushbuttons, pilot lights, & selector switches, use EFS back box with required external conduit seal for 1 inch hub size, within 5 feet for Class I, Division 1, Group B applications.
 †LED pilot lights can be furnished in place of standard incandescent pilot lamps. Add suffix LED to Cat. No. after last color symbol.

§ Can only be used with EFD Series 1½ gang back boxes. Pushbuttons include contact blocks. Standard pushbutton color is black. For optional colors - red, green - write in color. Example: DS511 GREEN BLACK RED-SA. First color is for uppermost button. For optional legend markings write in marking after device operator color. Example: DS513-J3 JOG-J1 STOP GREEN-SA.

Pilot Light Devices† Factory Sealed

Description	Diagram	Cat. #
With one pilot light		DSD948 ①
With two pilot lights (Not available with a transformer)		DSD947 ①
With one pilot light and transformer		DSD948 ① ②
With one pilot light and pushbutton station		DSD958 ①
With one pilot light and 1 double pushbutton station		DSD961 ①
With one pilot light & transformer and 1 double pushbutton station		DSD961 ① ②
Triple pilot light		DS512 ① SA§
Double pilot light - single pushbutton combo		DS513 ① SA§
Double pushbutton - single pilot light combo		DS514 ① SA§
With one pilot light & 2 position selector switch, two circuit (pos. 1 - N.O., pos. 2 - N.C.)		A1 A2 DSD973 ① ④
With one pilot light & 2 position selector switch, four circuit (pos. 1 - N.O., pos. 2 - N.C. for both switches)		A1 A2 B1 B2 DSD974 ① ④
With one pilot light & 3 position selector switch, two circuit (pos. 1 - N.O., pos. 2 - open, pos. 3 - N.C.)		A1 A2 DSD975 ① ④
With one pilot light & 3 position selector switch, four circuit (pos. 1 - N.O., pos. 2 - open, pos. 3 - N.C. for both switches)		A1 A2 B1 B2 DSD976 ① ④
With one pilot light & 3 position selector switch, four circuit (pos. 1 - N.C., pos. 2 - N.O., pos. 3 - N.O. for switch A; pos. 1 - N.O., pos. 2 - N.O., pos. 3 - N.C. for switch B)		A1 A2 B1 B2 DSD977 ① ④

Blank Cover

Description Cat. #
 Blank Cover DSD957

① Add color symbol for each pilot light from table below.

Color	Symbol	Color	Symbol	Color	Symbol
Red	J1	Amber	J6	Blue	J11
Green	J3	Clear	J10		

② Add suffix below for transformer primary voltage:

Transformers - Voltages above 125

Nom. Volts 50-60Hz Transformer	Primary Voltage Range	Suffix
220 / 110	220-240	T2
440 / 110	440-480	T4
550 / 110	550-600	T5

③ If desired, markings on indicating plates may be added to catalog number. Select from the list of standard markings below:

START	OFF	RESET	LIGHT ON
STOP	RUN	TRIP	HAND
ON	JOG	TEST	AUTOMATIC
EMERGENCY FORWARD	OPEN	DOWN	RAISE
REVERSE	CLOSE	IN	LOWER
	UP	OUT	

④ Specify indicating plate markings. Standard indicating plate markings available are as follows:

Two-Position

RUN, JOG	FAST, SLOW	IN, OUT
HAND, AUTOMATIC	OPEN, CLOSE	RAISE, LOWER
FORWARD, REVERSE	UP, DOWN	START, STOP
	ON, OFF	

Three-Position

JOG, OFF, RUN	1, OFF, 2
AUTOMATIC, OFF, HAND	OPEN, OFF, CLOSE
FORWARD, OFF, REVERSE	UP, OFF, DOWN
FAST, OFF, SLOW	

Crouse-Hinds

by E.T.N

4C